

SOLID WASTE FACILITY PERMIT

Facility Number:

26-AA-0001

1. Name and Street Address of Facility:

Walker Landfill
280 Offal Road
Coleville, California 96107

2. Name and Mailing Address of Operator:

Mono County Department of Public Works
74 North School Street
PO Box 457
Bridgeport, California 93517

3. Name and Mailing Address of Owner:

Mono County Department of Public Works
74 North School Street
PO Box 457
Bridgeport, California 93517

4. Specifications:

- a. Permitted Operations:** Solid Waste Disposal Site Transformation Facility
 Transfer/Processing Facility (MRF) Other: _____
 Composting Facility (MSW/green material/C&G)

b. Permitted Hours of Operation: Receipt of Refuse/Waste: Monday, Wednesday, Saturday, 7:00 AM - 6:30 PM
 Ancillary Operations/Facility Operating Hours: as described in JTD

c. Permitted Maximum Tonnage: 80 Tons per Day 500 Tons per Year

d. Permitted Traffic Volume: 25 Vehicles per Day

e. Key Design Parameters (Detailed parameters are shown on site plans bearing EA and CalRecycle validations):

	Total	Disposal	Text	Transfer/Processing	Composting	Transformation
Permitted Area (in acres)	43.5	10.4		1.6	0	0
Design Capacity (cu.yds)		340,716		0	0	0
Max. Elevation (Ft. MSL)		5580				
Max. Depth (Ft. MSL)		20				
Estimated Closure Year		2120				

Upon a significant change in design or operation from that described herein, this permit is subject to revocation or suspension. The attached permit findings and conditions are integral parts of this permit and supersede the conditions of any previously issued solid waste facility permit.

5. Approval:



Approving Officer Signature
(Name and Title)

Louis Molina, Environmental Health Director

6. Enforcement Agency Name and Address:

Mono County Environmental Health
1290 Tavern Road Suite 246
PO Box 3329
Mammoth Lakes, California 93546

7. Date Received by CalRecycle:

August 27, 2015

8. CalRecycle Concurrence Date:

November 5, 2015

9. Permit Issued Date:

November 12, 2015

10. Permit Review Due Date:

November 12, 2025

11. Owner/Operator Transfer Date:

**PRELIMINARY CLOSURE and
POSTCLOSURE MAINTENANCE PLAN**
for the
WALKER LANDFILL
Mono County, California

Prepared for:
MONO COUNTY DEPARTMENT OF PUBLIC WORKS
P.O. Box 457
Bridgeport, California 93517
(619) 932-5252

Prepared by:
VECTOR ENGINEERING, INC.
1601 Fairview Avenue, Suite H
Carson City, Nevada 89701
(702) 883-7065

Project No. 975043.00 (4)
October, 1995
Revised April, 1998
Revised June 1998

REVISED JANUARY 2002

SIGNATURE PAGE

This Preliminary Closure and Postclosure Maintenance Plan was prepared in accordance with generally accepted civil and geotechnical engineering practices applicable at the time the report was prepared. Vector Engineering, Inc., makes no other warranties, either expressed or implied, as to the professional advice provided under the terms of this agreement, and as described in this plan. This plan was prepared in general accordance with the requirements of Title 14 and Title 23 of the California Code of Regulations.

VECTOR ENGINEERING, INC.



Evan Nikirk, R.C.E. No. 46777
Engineering Manager

TABLE OF CONTENTS

PART I - Introduction

INTRODUCTION	1
--------------------	---

PART II - Preliminary Closure Plan

CONTENTS OF THE PRELIMINARY CLOSURE PLAN	3
General Site Description	3
Monitoring and Control Systems	4
General Description of Monitoring Control Systems	4
Drainage Control	4
Landfill Gas Monitoring and Control	4
Ground Water Monitoring Program	4
Current Land Use and Zoning	5
Estimated Closure Date	6
Schedule of Closure	7
Structure Removal	7
Decommissioning of Environmental Controls	8
Site Security	8
Final Cover Placement	8
Final Grading	10
Settlement Determination	10
Final Site Face – Slope Stability	10
Closure Construction	11
Survey Monuments	11
Final Site Face	12
Drainage Facilities	12
Slope Protection	13
Leachate Control Measures	14
Ground Water Monitoring	15
Gas Monitoring	15
Closure Cost Estimate	16
Performance Standards	16
Financial Responsibility	16

PART III - Preliminary Postclosure Maintenance Plan

Monitoring and Control Systems	17
General Description of Monitoring Control Systems	18
Drainage Control	18
Landfill Gas Monitoring and Control	18
Ground Water Monitoring Program	18
Postclosure Land Use	19
Inspection and Maintenance	19
Final Cover	19
Drainage Facilities	20
Vegetative Cover	21
Leachate Control Systems	21

LIST OF APPENDICES

APPENDIX A	- Reduced Drawings	attached
APPENDIX B	- Loading Rate Calculations and SRRE Waste Characterization	attached
APPENDIX C	- Water Sampling Parameters and Schedule	attached
APPENDIX D	- Land Use Zoning Map.....	attached
APPENDIX E	- Soil Testing Results.....	attached
APPENDIX F	- Eastin Cost Estimate Worksheets	attached
APPENDIX G	- Settlement Analysis and Stability Analysis	attached
APPENDIX H	- Drainage Facility Design.....	attached
APPENDIX I	- Erosion Control Calculations	attached
APPENDIX J	- Inspection Schedules	attached
APPENDIX K	- Financial Assurance Mechanism	attached
APPENDIX L	- Drawings.....	attached

Drawing No. 1 - Title Sheet and Location Map

Drawing No. 2 - Existing Topography and Facilities

Drawing No. 3 - Final Grading Plan

Drawing No. 4 - Cross Sections

Drawing No. 5 - Hydraulic Subarea Layout

Drawing No. 6 - Details

PART I INTRODUCTION

The following *Preliminary Closure and Postclosure Maintenance Plan for the Walker Landfill* is submitted to the Local Enforcement Agency (LEA), the California Integrated Waste Management Board (CIWMB), and the Lahontan Regional Water Quality Control Board (RWQCB) and has been prepared in accordance with the requirements specified in 27 CCR Section 21769, 21790, and 21825. For ease of review, this report is presented in a question and answer format, with the specific regulation printed in bold italics followed by an explanation of how each requirement has been satisfied.

The Walker Landfill is located approximately 2.5 miles northeast of the community of Walker in the Antelope Valley area of northern Mono County, California, as illustrated on Drawing 1, Title Sheet and Location Map. The landfill property, as defined by the Public Land Survey System, occupies Lot 3 of Section 9, Township 8 North, Range 23 East, Mount Diablo Base and Meridian (MDB&M). The landfill is located on 43.5 acres of land at latitude 38°32'N and longitude 119°27'W. The property is owned by Mono County; the site boundary is illustrated on Drawing 2, Existing Topography and Facilities. For convenience, the design drawings have been included as a reduced drawing set in Appendix A of this plan; full-size drawings are presented in Appendix L.

The Mono County Department of Public Works is responsible for operation of the Walker Landfill. The following persons can be contacted for information about the landfill during closure activities and the postclosure maintenance period:

Mr. Evan Nikirk, PE
Mono County Department of Public Works
Post Office Box 457 / 74 North School Street
Bridgeport, California 93517
(760) 932-5440

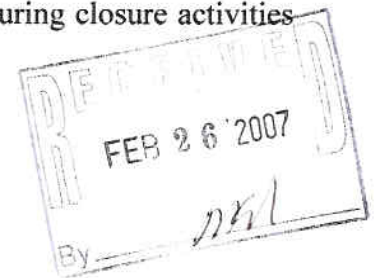

The Walker Landfill is a Class III municipal solid waste landfill as defined by 27 CCR Section 20200. The facility is a combined landfill and transfer station accepting non-hazardous solid waste and construction and demolition waste from a service area that includes the communities of Walker, Coleville, and Topaz. In addition, waste is accepted from those residents in the neighboring unincorporated areas of Douglas County, Nevada who have applied for, and have been issued, non-resident permits by Mono County.

The landfill operation, which accepts only a minor portion of the total service area waste stream, utilized the area fill method of disposal. The existing waste footprint covers approximately 10.4 acres; only inert debris and construction and demolition wastes remain on-site for disposal. Peripheral areas around the waste footprint are used for site access roads, borrow source excavation,

cover soil stockpile, drainage facilities, ground water monitoring wells, stockpiles of clean wood waste and the resulting wood chips, and transfer station operations. The existing waste footprint is illustrated on Drawing 2.

A permanent split-level transfer station has been constructed on-site to manage the residential and commercial waste streams and related waste diversion efforts. The facility, which was constructed on native soil north of the landfill footprint, consists of a 45-foot truck scale, gatehouse, concrete tipping pad, concrete retaining wall, waste compactor, generator, and paved roadways. Residential and commercial waste is processed through the transfer station and hauled off-site to the County's regional landfill, Benton Crossing Landfill, for disposal. Other wastes requiring temporary on-site storage or stockpiling prior to processing, recycling or special handling (e.g., tires, white goods, scrap metal, wood and green waste, used motor oil, and household hazardous wastes) are managed through the transfer station.

Based on a demonstration by Mono County, the site has been granted Very Small Landfill status by the RWQCB, resulting in reduced regulatory requirements. At the time the final configuration of the landfill was designed for this closure plan, the existing waste footprint was the only area planned to receive future solid waste. The engineering design is presented in the drawing set enclosed in Appendices A and L.

PART II
PRELIMINARY CLOSURE PLAN
WALKER LANDFILL

18261.3 CONTENTS OF THE PRELIMINARY CLOSURE PLAN

(a) The plan shall identify the steps necessary to perform either partial closure, in accordance with Title 14, CCR, Chapter 3, Article 7.8, Section 17764, or complete site closure shall include, but is not limited to, the following information.

- (1) a solid waste landfill location map indicating property boundaries, general location of the landfill, all on-site structures, entry roads, structures within 1,000 feet of the property boundary, current monitoring and control systems, total acreage of the solid waste landfill, total acres permitted for landfill, and the existing and proposed final limits of waste placement;***

The location of the site is illustrated on the Title Sheet and Location Map, Drawing 1. Drawing 2, the Existing Topography and Facilities Map, presents the locations of the existing disposal and stockpile areas of the site, the entrance road, property boundary, ground water monitoring well locations, and the existing waste footprint. Under the current design, the waste footprint, as delineated in Drawing 2, will be the final limit of waste placement. There are no inhabited dwellings or structures within 1,000 feet of the landfill property boundary. The closest inhabitable structure is approximately 1700 feet southwest of the property boundary and is a single family dwelling, refer to Drawing 1, Location Map.

- (2) topographic maps to include: pre-landfill and post-excavation topography; current topography; and, proposed final grading. Topographic maps shall be drawn to a scale and with a contour interval in accordance with the requirements of Title 14, CCR, Chapter 3, Article 7.8, Section 17776;***

Drawing 1 shows the topography in the vicinity of the disposal site in 1988, as illustrated on the United States Geological Survey (USGS) Risue Canyon, California 7.5-Minute Quadrangle. The current configuration and topography at the site are shown on Drawing 2, Existing Topography and Facilities, including the daily cover soil stockpiles, active disposal areas, and the limits of the existing waste footprint. The base topographic map presented on Drawing 2 was digitized from site maps contained in Kleinfelder (1992). Final grading topography after the closure of the entire site is shown on Drawing 3, Final Grading Plan.

- (3) an estimate of the maximum extent of the landfill that will ever require closure at any given time during the life of the landfill;***

The 10.4-acre waste footprint is the maximum extent of the landfill that will require closure construction at any one time. Waste loading rate calculations for the landfill are included in Appendix B, and the horizontal limits of fill are illustrated on Drawing 2, Existing Topography and

Facilities. The final grades after closure of the landfill are presented on Drawing 3, Final Grading Plan. The loading rate calculations and site life estimate for the final grades shown on Drawing 3 assume that the current disposal rate of 2 tons per day will continue into the future at modest growth rates consistent with population projections estimated by the California Department of Finance. The remaining portion of the waste stream is, and will continue to be, managed through the on-site transfer station located north of the waste footprint. Mixed household and commercial waste is transferred off-site to the Benton Crossing Landfill, located approximately 12 miles southeast of Mammoth Lakes, for burial. Based on the calculations presented in Appendix B, it is expected that the entire waste footprint will undergo closure construction once the landfill reaches final capacity in 2120.

(4) a description of the current monitoring and control systems at the landfill;

General Description of Monitoring and Control Systems

Mono County currently maintains a ground water monitoring system at the Walker Landfill. Surface water drainage and the abatement of dust, litter, odors, disease vectors, and fire are the responsibility of the landfill operator, the Mono County Department of Public Works. Existing site facilities are presented on Drawing 2, Existing Topography and Facilities. The following sections describe environmental monitoring and control systems that are in place at this time.

Drainage Control

At the present time, drainage control features consist of diversion berms, drainage channels, and culverts. The closure design calls for the construction of a system of channels around the perimeter of the site to collect and control run-off resulting from a 100-year, 24-hour storm event. A description of the proposed improvements in the drainage control features is presented in subsection 7G and Appendix H of this plan.

Landfill Gas Monitoring and Control

Quarterly landfill gas monitoring currently consists of ambient air sampling around the site perimeter and within structures at the transfer station. If a subsurface perimeter landfill gas monitoring system is required to be installed prior to landfill closure, Mono County will implement such a system. A detailed description of the proposed gas monitoring system to be installed during closure construction is presented in subsection 7K of this plan and on Drawing 6, Details.

Ground Water Monitoring Program

The Walker Landfill currently has three wells for monitoring ground water quality (wells MW-1, MW-2, and MW-3). The upgradient well (MW-2) monitors ground water that flows into the landfill area from the hydraulically higher portion of the drainage basin, and therefore provides background chemistry for constituents of concern. The down-gradient wells (MW-1 and

MW-3) monitor ground water that has passed beneath the refuse area and exited the landfill site, providing an early warning in the event of a contaminant release from the landfill.

The existing monitoring wells were installed in May, 1988 under the supervision of Kleinfelder, Inc. A detection monitoring program was initiated at the site by Kleinfelder, Inc., in 1988, beginning with the installation and development of the monitoring wells. Vector Engineering, Inc., took over the detection monitoring program in 1992. Vector currently performs quarterly ground water monitoring services at the Walker Landfill.

The monitoring program is designed to monitor both background and down-gradient concentrations of indicator parameters and possible leachate constituents. The water samples obtained during the quarterly monitoring events are analyzed for concentrations of metals, minerals, volatile organics, and general indicator parameters. The sampling frequency and analysis of the wells is currently being performed in accordance with 1995 Waste Discharge Requirements established by the Lahontan RWQCB. The chemical constituents that are currently being monitored and the prescribed sampling frequency are presented in Appendix C of this plan. Ground water monitoring activities will continue throughout the postclosure period on a quarterly basis unless the results of ground water monitoring indicate that the site has stabilized, and either a reduced monitoring frequency or a shortened postclosure maintenance period is approved by the appropriate governing agencies.

- (5) *a description of the current land uses within one mile of the permitted area. This is to include the zoning and specific industries within the one mile area and shall reference the specific page or map number for the particular county planning agency. The plan shall also include any proposed postclosure land use, subject to the requirements of Title 14, CCR, Chapter 3, Article 7.8, Section 17796, at the site, if so designated in the County General Plan or other planning documents;*

The County of Mono owns the landfill property, which is zoned as PF, for public or quasi-public facilities. This zoning allows development for a number of uses, including landfill disposal; therefore, the use of the site is in compliance with the local zoning ordinances. The land use designations in the vicinity of the landfill are illustrated on the land use zoning map presented as Figure 5 in the Land Use Element of the Mono County General Plan. A copy of the map is enclosed in Appendix D of this closure plan.

The majority of the land in the vicinity of the disposal site is publicly owned and administered by BLM. The BLM lands in the region are zoned as RM, or resource management, and are used predominantly for recreation and livestock grazing. A portion of the town of Walker

is within one mile of the landfill; this area is zoned as ER and LI, for estate residential and light industrial, respectively. Several residences are located within one mile of the landfill.

Prior to the completion of closure activities, the Mono County Department of Public Works, as site owner and operator, will cause to be placed in the deed to the site, or some other instrument that is normally examined during a title search, information notifying potential purchasers of the property that the site has been used as a landfill. In addition, the deed will be modified to state that the use of the parcel is restricted in accordance with the postclosure land uses set forth in the final postclosure maintenance plan and Waste Discharge Requirements (WDRs) for the landfill, and that the property owner will be responsible for carrying out the postclosure maintenance plan and any corrective action necessary to address a release. The CIWMB and RWQCB will be provided with a copy of the proposed deed language for review and comment prior to its recordation; a copy of the modified deed will then be forwarded to those agencies once it has been recorded.

The postclosure land use for the Walker Landfill property has not been definitively determined at this time. However, the transfer station will remain in operation and it is anticipated that the landfill portion will revert to open space during and following the postclosure period. The final cover will be constructed to blend with the surrounding topography and will be seeded with native plant species. Both the transfer station operation and landfill open space are consistent with the Public Facility (PF) land use designation currently assigned to the property. Any postclosure land use of the property will be in accordance with Title 27 regulations.

(6) an estimate of the closure date based on volumetric calculations. The estimate shall account for the effects of settlement and refuse to cover ratio in the calculations. Documents for arriving at the conclusions shall be provided;

In order to estimate active site life of the landfill, the following assumptions were made:

- total remaining fill capacity at the beginning of 2006, based on disposal records and the design presented in Drawing 3, Final Grading Plan, is 279,036 cubic yards for waste and cover soil;
- current waste disposal rate is estimated at 2.0 tons per day on an annual average;
- waste is compacted to 800 lbs/cy (Caterpillar, 1992);
- waste stream growth rate is based on population growth projections estimated for Mono County by the California Department of Finance; and,
- waste-to-soil ratio for landfill cover is 2:1.

Loading rate and site life calculations based on these assumptions are included in Appendix B. As previously described, the loading rate calculations and site life projections estimate that approximately 2.0 tons per day of waste will be disposed at the Walker Landfill, reflecting the

site's current operation with a transfer station and minimal amount of waste being disposed within the active disposal cell. The majority of waste delivered to the site is disposed at the transfer station, which is then compacted into an enclosed roll-off transfer container, loaded onto a tilt-frame truck on a regular schedule, and hauled to the County's regional landfill, Benton Crossing Landfill, for ultimate disposal. Growth projections are based on population estimates of Mono County prepared by the California Department of Finance.

Based on the final grading design presented on Drawing 3 and disposal records compiled for the site, it is estimated that 279,036 cubic yards of disposal capacity was available at the time of the closure fund deposit calculation at the end of October, 2005. Assuming a waste-to-soil ratio of 2:1, this remaining volume is comprised of an estimated 186,024 cubic yards of waste and 93,012 cubic yards of cover soil. The 2:1 waste-to-soil ratio reflects the operational inefficiencies of routinely covering a very small volume of waste with six to nine inches of compacted cover. This volume of waste, compacted at 800 pounds per cubic yard (lb/cy), is equivalent to 74,410 tons of waste. Based on this data and the assumptions presented on the preceding page, it is reasonable to predict a conservative site life of 114 from the beginning of 2007 and a final receipt of waste late in the year 2120.

- (7) ***a general description of the methods, procedures, and processes that will be used to implement closure, including the personnel, equipment and materials necessary for each aspect of closure. The plan shall propose a general time estimate for completing each task. The activities described shall include, but are not limited to:***

Mono County, as owner of the Walker Landfill, will submit a Final Closure and Postclosure Maintenance Plan to the LEA, CIWMB, and RWQCB for approval two years prior to the anticipated date of closure. These regulatory agencies will be notified upon the final receipt of waste at the site and prior to the commencement of closure activities. Closure construction will be initiated within 30 days of the final receipt of waste, and is expected to be completed within 180 days. Should it be anticipated that closure construction will take longer than 180 days, an approved extension will be sought from the LEA, CIWMB, and RWQCB before the 180-day schedule has elapsed. The following subsections outline the specific tasks of the closure process.

(A) removal of solid waste landfill structures;

All equipment that will not be used on-site during the postclosure maintenance period will be removed. It is currently planned that the transfer station will continue to operate at the site following landfill closure. All other structures remaining at the site following the final receipt of waste, and which will not be an integral part of postclosure site maintenance, will be dismantled

operations will be dismantled and removed from the site as part of closure activities; therefore, structure removal will occur within 180 days of commencement of closure activities. Should there be any change to these plans, they will be reflected in the *Final Postclosure Maintenance Plan*.

(B) decommissioning of environmental controls pursuant to Title 14, CCR, Section 17772;

At this time, there are no plans to decommission any of the environmental control systems at the site during the post-closure maintenance period. Following completion of post-closure maintenance, and as approved by the RWQCB, CIWMB, and the LEA, all monitoring wells and probes will be abandoned in accordance with applicable local and state regulations in effect at that time. Drainage facilities will remain in-place to protect the integrity of the waste mass.

(C) providing site security pursuant to Title 14, CCR, Section 17767;

A partial perimeter fence and locking gate has been installed around a portion of the western and southern boundaries of the landfill to prevent unlawful entry and disposal at the Walker Landfill. The geographic constraints of steep canyon walls prevent access to the unfenced portions of the site. Signs posted at the site entrance provide information pertaining to the site operating hours, owner and operator, and emergency telephone numbers. Sixty days prior to landfill closure, a sign will be posted at the site entrance to provide information regarding the locations of alternate permitted disposal facilities and the intended landfill closure date. As stated above, transfer operations will continue at the site following landfill closure. Within ten working days of the final receipt of waste for disposal, a sign will be installed at the site entrance stating where the *Final Closure and Post-Closure Maintenance Plan* can be examined. At a minimum, site security measures will meet the requirements of all portions of Title 14, CCR, Section 17767. All monitoring wells at the site are protected from unauthorized access by a locking surface casing.

(D) placement of final cover pursuant to Title 14, Section 17773, including identification of potential sources of suitable materials;

Final grades and the closure cap for the Walker Landfill have been designed in accordance with Title 14, CCR, Chapter 3, Article 7.8, Section 17773 and Title 23, CCR, Chapter 15, Section 2581(a). The final cover will provide a long-term barrier to fluid migration through the waste mass, isolate wastes from the elements, and promote surface drainage away from the landfill. Grading design minimizes erosion of the cover and the potential impact of maximum anticipated seismic forces, yet provides sufficient slope to accommodate drainage following the effects of subsidence while maintaining the integrity of the final cover.

The final cover over the landfill will be constructed in accordance with Chapter 15 requirements. The cap will consist of a 24-inch foundation layer, half of which will be placed during disposal operations, overlain by a geosynthetic clay liner (GCL) and an 18-inch layer of topsoil. This cap will cover all surfaces of the top deck and side slopes in the disposal area, as illustrated on Drawing 3. A detailed drawing which presents a profile of the final cover design has been included on Drawing 6, Details.

Rough contouring will be performed throughout the life of the site during daily operations. Following the general site cleanup, final contouring and compaction and placement of the foundation layer will be performed to establish a suitable foundation for final cover construction. The site will then be surveyed to establish base elevations for final cover construction and verify minimum final slope grades of at least three percent. After final grading of the foundation layer, the geosynthetic clay liner will be installed.

A geosynthetic clay liner will be installed in place of the prescriptive compacted clay layer. Installation of the GCL and associated field testing will be performed as part of a Construction Quality Assurance (CQA) closure certification program. Material laboratory test work will be used to establish the field test criteria. A Closure Certification Report will be prepared and will include the material characteristics for the geosynthetic clay liner installed, as well as the procedures and results of the field methods used during the CQA Program. The RWQCB, LEA, and the CIWMB will be provided with copies of the Closure Certification Report upon its completion.

Following the installation and certification of an approved geosynthetic clay liner, a minimum of 18 inches of native soil will be placed over the liner in accordance with Title 23, CCR, Chapter 15, Section 2581(3). Although this thickness exceeds the prescriptive requirements, the additional six inches of thickness is proposed to ensure protection of the GCL from root penetration and frost damage. The erosion, or vegetative, layer will be capable of sustaining native plant growth and preventing excessive amounts of erosion. The layer will be seeded or hydroseeded with a seed mixture designed or recommended by a representative of the United States Department of Agriculture Natural Resource Conservation Service.

Drainage facilities proposed for installation on the final cap, including the headwall berm, downdrain, and top deck access road v-ditch, will be constructed during closure activities as described in subsection 7G and Appendix H of this plan, and as illustrated on Drawing 3 (Appendix J). Existing perimeter drainage channels will be neatly trimmed following final cover construction

to ensure that ditch geometry and carrying capacity are capable of handling the anticipated design flows. The drainage structures will assist in maintaining the integrity of the final cover and preventing a washout of waste due to uncontrolled run-off during storm events. A final cover constructed in accordance with the design standards set forth in Title 23, CCR, Chapter 15, and as illustrated on Drawing 6, will be sufficient to prevent infiltration of surface waters through the underlying waste mass.

(E) final grading in accordance with Title 14, CCR, Chapter 3, Article 7.8, Section 17776;

Final Grading

The final grading plan of the landfill is designed to accommodate the predicted future settlement of the landfill and to minimize flow velocities over the final surface of the landfill and in the run-off diversion channels. The closure design is illustrated on Drawings 3 and 4. The entire waste footprint is included in the closure design. The final topography of the closed landfill was designed to blend with the surrounding topography while maintaining a minimum grade of three percent on all slopes. As illustrated on Drawing 3, the design incorporates smooth sideslopes and a perimeter access road and drainage. The landfill top deck and sideslopes will be graded at a minimum of three percent into a perimeter drainage channel, which will route flows from the landfill surface into a natural drainage channel to the west of the waste fill. The final grade surface of the landfill will meet the requirements of Title 14, CCR, Chapter 3, Section 17776 and Title 23, CCR, Chapter 15, Section 2581(b).

Settlement Determination

A prediction of the total waste settlement was performed based on a study by Edil, et. al. (1990), entitled "Settlement of Municipal Refuse". The study was initially presented at Geotechnics of Waste Fills - Theory and Practice, ASTM STP 1070 in Philadelphia, Pennsylvania in 1990. A copy of this paper has been included with the settlement predictions presented in Appendix G. The study analyzed two mathematical models for determination of settlement within four municipal solid waste landfills located in Wisconsin, Michigan, and Connecticut. The Power Creep Law, used extensively in modeling the transient creep behavior of engineering materials, was found to effectively represent actual waste settlement in the field and was utilized for this analysis. Waste input parameters for the model were taken from average data for the four sites examined in the study. Because the Walker Landfill is located in an arid climate and would therefore be less susceptible to biological and chemical decay processes than the landfills examined by Edil, et. al. (1990), it can be expected that the input parameters used in the settlement prediction will yield conservative results, and that the actual settlement may be considerably less than predicted.

The settlement calculations (Appendix G) indicate that the proposed closure will settle an estimated 3.6 feet during the 30-year postclosure period. With proper maintenance, the predicted magnitude of settlement will not significantly affect the ability of the landfill slopes to promote drainage from the surface of the landfill. In order to effectively monitor the settlement of the waste mass during the postclosure period, permanent settlement monuments will be installed on the top deck of the final landfill surface following closure construction. The proposed settlement monument locations are depicted on Drawing 3, Final Grading Plan. The installation of settlement monuments is discussed in further detail later in this section.

Closure Construction

Closure construction for all elements of the closure design will be performed by a licensed contractor. It is anticipated that the contractor will use a scraper, sheepfoot compactor, water truck and bulldozer to complete closure activities. Alternatively, a wheel loader and dump truck may be used in place of the scraper, given the small size of the site. All equipment will be operated by experienced personnel. Only areas which require grading will be disturbed and a water truck will be used at all times to aid in compaction and minimize the generation of fugitive dust. If necessary, chemical additives will be employed in the dust control operations.

During the construction of the final cover layer, survey crews will verify that the cover has been constructed to the prescribed elevations and dimensions in accordance with the approved plans and specifications and Title 14, CCR, Chapter 3, Section 17776 and Title 23, CCR, Chapter 15, Section 2581(a). All survey information produced as part of the closure construction will be compiled in maps showing the final elevations of the top of each layer. The map will be presented in the final Closure Certification Report for closure.

Survey Monuments

Following the completion of closure construction, five permanent settlement monuments will be installed to monitor settlement of the waste mass in accordance with Title 23, CCR, Chapter 15, Sections 2580(d) and 2581(c)(5). Two additional survey control monuments will be installed in undisturbed, native soil near the eastern boundary of the disposal cell, and will provide horizontal and vertical control points during postclosure surveying. The approximate locations of survey and settlement monuments are illustrated on Drawing 3. All monuments will be installed by a licensed land surveyor or a registered civil engineer. The monuments will provide reference points from which the location and elevation of the waste and monitoring facilities can be determined by ground surveys throughout the postclosure maintenance period. Iso-settlement maps will be generated from the topographic information obtained. The final cover will be repaired and

maintained based on the information acquired during the settlement surveys. Continual maintenance will be performed to prevent ponding on, and promote drainage away from, the landfill surface. All iso-settlement maps will be produced with a contour interval of not more than two feet. If only very small amounts of settlement are indicated from the first postclosure settlement survey, additional iso-settlement maps may be discontinued.

(F) final site face pursuant to Title 14, CCR, Chapter 3, Article 7.8, Section 17777. The slope stability report, when required, shall be submitted with the final closure plan;

According to the Seismic Safety Element included in the Mono County General Plan, the Walker Landfill is not located in an area subject to liquefaction, nor is it located in an unstable area with poor foundation conditions. The final site face for the Walker Landfill has been designed in accordance with Title 14, Section 17777. The design slopes for the closure area will not exceed a three to one horizontal to vertical configuration. Also, the final cover includes a GCL. Due to the fact a GCL liner will be used in the final cover, a stability analysis of the final site face was performed for completeness of the preliminary closure plan. The stability analysis has been included in Appendix G.

(G) installation of drainage controls pursuant to Title 14, CCR, Chapter 3, Article 7.8, Section 17778;

Proposed drainage control systems for closure have been designed to accommodate the anticipated volume of precipitation and peak flows from surface run-off under 100-year, 24-hour precipitation conditions. As part of the closure construction, appropriate quality control procedures will be implemented to ensure that the final drainage system is constructed according to the approved closure plan.

During facility operation, a system of drainage channels and culverts will be constructed to route run-on and run-off from the closed landfill surface. Drainage facilities proposed for installation on the final cap, including the headwall berm, downdrain, and maintenance bench v-ditch, will be constructed during closure activities. The existing perimeter channel will be neatly trimmed following final cover construction to ensure that ditch geometry and carrying capacity are capable of handling the anticipated design flows. The flared end sections and culvert, which will be in-place prior to landfill closure, will be protected during closure activities to minimize potential damage from heavy equipment.

A hydrologic analysis was performed to estimate the peak flow rates for run-off from the closed landfill surface using the Soil Conservation Service's TR-55 method (USDA, 1986). The predicted peaks flows were then used in conjunction with the FlowMaster I computer

program (Haestad, 1990) to design and size a system of channels and culverts to route run-off from the site. Run-on flow will be diverted around the site in an existing 48-inch deep trapezoidal diversion channel and re-directed into a natural drainage channel to the west of the site. Drawing 5 illustrates the drainage sub-areas used in the hydraulic analyses. The designed sizes for the channels and culvert at the site are included on Drawing 5 and summarized in Table H-2, Summary of Hydraulic Design, located in Appendix H. All drainage channels and areas potentially susceptible to erosion will be lined with a protective erosion mat or rip-rap material.

Drainage facilities at the landfill will be installed using appropriate personnel and equipment by the construction contractor. All drainage channels constructed to divert water from the landfill will be inspected and repaired annually during the active life and postclosure period to ensure that ponding does not occur. Sedimentation in the culvert and ditches will be removed periodically to maintain the effectiveness of the drainage system. All drainage facilities will be constructed in accordance with the requirements of Title 14, CCR, Chapter 3, Section 17778 and Title 23, CCR, Chapter 15, Section 2546(a). A thorough discussion of the drainage system design, including summary tables, hydraulic calculations, and output files, is presented in Appendix H.

(H) slope protection and erosion control pursuant to Title 14, CCR, Chapter 3, Article 7.8, Section 17779;

All final slopes of the final landfill surface will be constructed to minimize erosion and protect the integrity of the final cover. This will be accomplished by the establishment of a vegetative cover which is designed to require a minimum amount of maintenance and have a rooting depth which will not penetrate the infiltration barrier layer. A seed mixture of native plant species will be developed based on input from NRCS field office personnel in Gardnerville, Nevada. The type(s) of vegetation selected will also be based on the speed of germination and growth, the surface coverage, self-propagation, and resistance to environmental stresses such as disease and landfill gas. Soil loss and erosion will be further minimized by maintaining relatively shallow slopes which are sufficient to promote drainage without enhancing the scouring effect of run-off. In addition, a series of trees will be planted during facility operations to provide wind breaks along the west side of the landfill footprint to minimize the effects of wind erosion from the prevailing winds blowing primarily from west to east. Since the trees will be planted during the operational life of the landfill, they will be sufficiently mature upon landfill closure to provide erosion protection during the postclosure maintenance period. As noted in previous sections, the erosion layer included in the final cover design will be 18 inches in thickness rather than the 12 inches prescribed by solid waste regulations. Slope protection and erosion control measures will be

in accordance with the requirements of Title 14, CCR, Section 17779 and Title 23, CCR, Chapter 15, Section 2581(b).

An estimate of the potential soil loss during the closure construction phase and the postclosure maintenance period was computed using the Universal Soil Loss equation, and the wind erosion equation developed by the USDA to determine soil loss due to rainfall and wind, respectively. On the top deck of the landfill, the predicted soil erosion rate due to rainfall and surface water sheet flow is about half of that predicted by the wind erosion equation. The predominant cause of erosion on the side slopes is predicted to be due to rainfall and surface water sheet flow. It should be noted that the wind erosion analysis is considered overly conservative in that it does not account for soil surface armoring that will likely develop over time. The results of the analysis projects a total soil loss from the combined effects of wind and rain of 20.9 tons per acre from the top deck and 39.4 tons per acre from the sideslope area in the initial year of construction, assuming full site exposure without the benefit of a tree wind break. Following establishment of vegetation on landfill surfaces, it is estimated that erosion will result in a loss of 8.1 tons per acre from the top deck and 20.5 tons per acre from the sideslope area during each subsequent year. It is estimated that a maximum of 0.6 inches of soil will erode from the landfill sideslopes during the first five years of postclosure, and potentially as much as 2.9 inches during the entire maintenance period. Top deck erosion rates are predicted to be significantly less than sideslope erosion rates.

The mitigating effects of the tree wind break is expected to significantly reduce the amount of soil loss due to wind erosion, and thus total erosion. The effectiveness of the tree break was analyzed for four different tree heights: 20 feet, 40 feet, 60, and 80 feet. With a wind break, it is anticipated that total annual soil loss will be 19.6, 18.9, 17.4, and 14.9 tons per acre from the sideslope area for the four scenarios, respectively. Sideslope erosion is considered the worst case area due to the higher erosion estimates from the impacts of storm water. The total soil loss from sideslopes during the postclosure period is expected to range between two inches and 2.7 inches with a tree break, depending upon tree height. Detailed soil loss calculations and a description of the method to determine erosion estimates for the landfill are presented in Appendix I of this report.

(I) *implementation of leachate control measures pursuant to Title 14, CCR, Chapter 3, Article 7.8, Section 17781;*

Since waste placement at the Walker Landfill will not extend beyond the existing waste footprint established at the site, and since there currently is no leachate monitoring program

at the landfill, installation of a base liner or leachate collection and removal system will not be required. Any future lateral expansion at the site will be designed under applicable regulatory requirements for municipal solid waste management units at that time.

(J) installation of the ground water monitoring network pursuant to Title 14, CCR, Section 17782; and,

Three monitoring wells have been installed at the landfill and comprise the ground water monitoring network. The monitoring network will remain in operation through the post-closure maintenance period. Ground water sampling and testing are being performed in accordance with the Waste Discharge Requirements established by the Lahontan RWQCB and in accordance with Title 23, CCR, Chapter 15, Section 2581(c)(3). The ground water sampling frequency is listed in Appendix C of this report.

(K) installation of gas monitoring and control systems pursuant to Title 14, CCR, Section 17783.

To facilitate landfill gas monitoring during the post-closure maintenance period, a network of gas wells and vents will be installed on and around the site. Gas monitoring wells will be installed around the perimeter of the site at an interval not to exceed one for every 1,000 feet laterally, and gas vents will be installed on the closure surface. The proposed locations of gas monitoring wells and vents are illustrated on Drawing 3, Final Grading Plan. The depth of gas monitoring wells will vary from a minimum of 30 feet to a maximum of 110 feet below ground surface. A series of probes will be installed in each well in accordance with Chapter 3, Article 7.8. Following placement of the final cover, gas vents will be installed on the closed landfill surface to prevent the build-up of potentially harmful or explosive gases under the final cap. Gas monitoring probe and vent details are presented on Drawing 6.

Gas monitoring wells will be installed by a licensed drilling contractor pursuant to the requirements of 14 CCR 17783.5(d). The completed depth of each gas monitoring well will be equal to the maximum depth of waste fill located within 1,000 feet of the monitoring location. Given the trench construction method historically employed by Mono County operators, the maximum depth of waste is 30 feet below ground surface. Therefore, with a minimum ground elevation of approximately 5500 feet at the site, the elevation at the full depth of each proposed gas monitoring well will be 4970 feet. Two to three probes will be installed at each monitoring location, depending upon bore depth. One probe will be located at the full bore depth, one will be positioned at the mid-depth, and one probe will be installed near ground surface. Installation depths of the gas probes will account for site specific migration pathways.

Gas monitoring during the post-closure maintenance period will consist of quarterly gas surveys to detect the presence of methane in the perimeter monitoring probes. In addition, monitoring of ambient air will be performed in the scalehouse, which has been installed at the on-site transfer station. Since the scalehouse is a portable structure constructed on skids, air flow permitted between the ground and elevated floor should reduce the potential for gas build-up in the enclosure. The concentration of methane gas will be monitored and will not be permitted to exceed five percent by volume in air at site boundaries or 1.25 percent by volume in air in the scalehouse. Sampling and analysis for trace gases is not proposed at this time, but will be performed should it be required by the LEA, CIWMB, or Great Basin Air Pollution Control District. Sampling frequency may increase if methane is detected at levels greater than five percent at the property boundary. Since the rate of biological degradation of waste is expected to decrease over time, a decrease in the monitoring frequency may be proposed by Mono County if methane is not detected for an extended time during the post-closure period.

(8) the closure cost estimate pursuant to Section 18263 of this Article.

The preliminary cost estimate for the closure of the Walker Landfill was calculated using a detailed construction cost estimating spreadsheet, which was based on Eastin Cost Estimate Worksheet. The cost estimate spreadsheet is presented in Appendix F of this report. The total estimate for final cover installation and closure construction activities is estimated to be \$590,200. The cost estimate has been increased by 20 percent to account for cost over-runs. The enclosed closure cost estimate includes information on final cover installation, CQA monitoring, surface revegetation, landfill gas and ground water monitoring systems, drainage control facilities, site security, structure removal, and development of applicable designs, plans, and reports.

(9) where one of the above requirements identifies a standard of performance for solid waste landfills, the preliminary closure plan shall describe how a proposed design, monitoring or control method supports the performance standard.

There are no performance standards identified as part of this Plan.

18267 FORM OF APPLICATION FOR REVIEW OF CLOSURE AND POST-CLOSURE MAINTENANCE PLANS

(c) An updated demonstration of financial responsibility in accordance with Article 3.5 of this chapter. This demonstration shall reflect the updated cost estimates for closure and post-closure activities required under subsection (b), above

On October 5, 1993, the Mono County Board of Supervisors, through Resolution No. 93-75, established a Special Revenue Fund to ensure that monies deposited to provide adequate closure construction funding are held in trust. The resolution establishes an account specifically for each of the landfills operated by Mono County. Annual deposits are made by the County into the Fund account established for the Walker Landfill. A copy of the resolution and associated financial assurance documentation, including CIWMB approval, is included in Appendix K of this Plan.

**PART III
PRELIMINARY POSTCLOSURE MAINTENANCE PLAN
WALKER LANDFILL**

Section 18264. PRELIMINARY POSTCLOSURE MAINTENANCE PLAN

- (a) The purpose of the preliminary postclosure maintenance plan is to:***
- (1) allow the operator to prepare an estimate of postclosure monitoring, maintenance, and the inspection costs;***
 - (2) enable the Board and local enforcement agency to assess the reasonableness of the cost estimate, and;***
 - (3) allow a registered civil engineer or certified engineering geologist to certify to the accuracy of the cost estimate.***

This preliminary postclosure maintenance plan presents the procedures and maintenance activities which will be performed during the postclosure period. From this information, an estimate of the postclosure monitoring, maintenance, and inspection costs has been calculated; the cost estimate is presented in Appendix F. The information contained in this plan will also enable the California Integrated Waste Management Board (CIWMB) and local enforcement agency (LEA) to assess the accuracy of the postclosure cost projections, and allow a registered civil engineer or certified engineering geologist to certify the accuracy of the cost estimate.

A Postclosure Certification Report will be prepared at the conclusion of the postclosure maintenance period and will certify that site activities have been completed according to the approved Postclosure Maintenance Plan. The Regional Water Quality Control Board (RWQCB), the LEA, and the CIWMB will be provided with copies of the Postclosure Certification Report upon its completion.

Section 18264.3. CONTENTS OF THE PRELIMINARY POSTCLOSURE MAINTENANCE PLAN

- (a) The preliminary postclosure maintenance plan shall include, but is not limited to the following information. The Board or local enforcement agency may require additional items based on specific site characteristics.***
- (1) A description of the current monitoring and control systems at the landfill. The description of existing systems shall include a statement of how collection, recovery, and control systems are operated, the frequency of operation, and the method of storage, treatment, or disposal for all materials collected or recovered;***

General Description of Monitoring and Control Systems

The Walker Landfill currently operates monitoring and control systems at the site which must be maintained throughout the active disposal period, as well as during closure construction activities and for the duration of the postclosure maintenance period. This system consists of ground water monitoring wells installed to evaluate potential migration of leachate into the saturated zone beneath the site. The following sections describe each of the monitoring and control systems which were in effect at the landfill site at the time this plan was prepared.

Drainage Control

At the present time, drainage control features that exist at the site consist of diversion berms and drainage channels. Final site design calls for the construction of v-ditches around the perimeter of the site to collect and control the run-on and run-off resulting from a 100-year, 24-hour storm event. A description of the proposed improvements in the drainage control features are presented in subsection 7G and Appendix H of the attached Preliminary Closure Plan. The drainage control system will be inspected according to the schedule presented in Appendix J.

Landfill Gas Monitoring and Control

At the present time, landfill gas monitoring is not performed at the landfill. Based on a demonstration by Mono County, the site has been granted Very Small Landfill status by the Lahontan RWQCB, and landfill gas monitoring is currently not required during the operational life of the landfill. If landfill gas monitoring is required prior to closure a landfill gas monitoring system and plan will be developed. A detailed description of the proposed gas monitoring system to be installed during closure construction is presented in subsection 7K of this plan.

Ground Water Monitoring Program

The Walker Landfill currently has three wells for monitoring ground water quality (wells MW-1, MW-2, and MW-3). The up-gradient well (MW-2) monitors ground water that flows into the landfill area from the hydraulically higher portion of the drainage basin, and therefore provides background chemistry for constituents of concern. The down-gradient wells (MW-1 and MW-3) monitor ground water that has passed beneath the refuse area and exited the landfill site, providing an early warning in the event of a contaminant release from the landfill.

The existing monitoring wells were installed in May, 1988 under the supervision of Kleinfelder, Inc. A detection monitoring program was initiated at the site by Kleinfelder, Inc., in 1988 beginning with the installation and development of the monitoring wells. In 1992, the detection monitoring program was taken over from Kleinfelder, Inc., by Vector Engineering, Inc. Vector currently performs quarterly ground water monitoring services at the Walker Landfill.

The monitoring program is designed to monitor both background and down-gradient concentrations of indicator parameters and possible leachate constituents. The water samples obtained during the quarterly monitoring events are analyzed for concentrations of metals, minerals, volatile organics, and general indicator parameters. The sampling frequency and analysis of the wells is currently being performed in accordance with 1995 Waste Discharge Requirements established by the Lahontan RWQCB. The chemical constituents that are currently being monitored and the prescribed sampling frequency are presented in Appendix C of this plan. It is proposed that ground water monitoring activities will continue throughout the postclosure period on a semi-annual basis unless the results of ground water monitoring indicate that the site has stabilized, and either a reduced monitoring frequency or a shortened postclosure maintenance period is approved by the appropriate governing agencies.

- (2) ***A description of the planned uses of the property during the postclosure maintenance period. Site use during the postclosure maintenance period shall be in accordance with the requirements of Title 14, C.C.R., Chapter 3, Article 7.8, Section 17796.***

With the exception of the operation of the permanent transfer station, the postclosure land use for the Walker Landfill property has not been determined. However, it is anticipated that the disposal site will return to an open space designation following the postclosure period. The final cover will be constructed to blend with the surrounding topography and will be hydroseeded with native annual vegetation. A subsequent postclosure land use as open space is compatible with the resource management zoning designation for surrounding areas. Any postclosure land use of the landfill property will be in accordance with Title 14, CCR, Article 7.8, Section 17796.

- (3) ***A general description, sufficient to meet the requirements of Subsection 18264(a), of this Article, of the methods, procedures and processes, that will be used to maintain, monitor and inspect closed landfills during the postclosure maintenance period in a manner consistent with the requirements of Title 14, CCR, Chapter 3, Article 7.8. At a minimum, the plan shall include, but not be limited to the following:***
 - (A) ***A program to maintain the integrity and effectiveness of the final cover, as designed, including making repairs to the cover as necessary to correct the effects of settling, subsidence, erosion or other events.***

The final cover has been designed in accordance with Title 14, CCR, Chapter 3, Article 7.8, Section 17773 and Title 23, CCR, Chapter 15, Section 2581(a). A geosynthetic clay liner (GCL) is proposed in place of the prescriptive compacted clay layer. With proper maintenance, it will provide a long-term barrier to fluid infiltration, isolate the waste fill from the

environment, and promote drainage away from landfilled areas. The following inspection and maintenance procedures have been developed to ensure the effectiveness of the final cover layer throughout the postclosure period.

The final cover will be inspected on a quarterly basis for any breach of the integrity of the cover. The individual performing the inspection will search for areas of settlement, subsidence, or erosion. Damaged areas or areas which require topsoil and/or geosynthetic clay liner replacement will be cut back laterally until undisturbed geosynthetic clay liner is reached. The area of damaged geosynthetic liner will then be replaced and the exposed liner will be covered with 18 inches of soil. The top surface will be scarified and hydroseeded with a mixture of fertilizer and native grass seed.

In the case of subsidence or settlement, the subsurface problem will be identified, and any repairs will be made using on-site soil to repair the area to its original design thickness and 3 percent slopes according to the procedures outlined above.

(B) A program to inspect and maintain the drainage system, as designed, to prevent run-on and run-off from adversely affecting the integrity of the final cover.

The drainage control system has been designed to accommodate the anticipated volume of precipitation and peak flows and surface run-off resulting from a 100-year, 24-hr precipitation event. The slope face of the closure surface will be uniformly graded at three to one (3:1), horizontal to vertical. The slope configuration will promote drainage from the surface of the landfill, but will prevent excessive erosion of the final cover. All drainage areas susceptible to erosion will be lined with an erosion mat or rip-rap. The sideslopes of the final cover will drain into perimeter channels. The perimeter channel will direct all run-off from the surface of the landfill into a culvert at the west corner of the site prior to discharge into natural drainage channels off-site.

Drainage facilities at the landfill will be installed either during the operational life of the facility or as part of closure construction activities, as described in subsection 7G of the attached Preliminary Closure Plan. Drainage structures installed during landfill closure will be performed by the construction contractor and will be built using appropriate personnel and equipment. All drainage channels constructed to divert water from the landfill will be inspected as part of the periodic landfill inspections during the operating life, and semi-annually during the postclosure period to ensure the effectiveness of the system. In addition, the drainage facilities will be inspected during the active life and the postclosure maintenance period after each heavy

precipitation event to verify the integrity of the run-off system. Any channels which require repair will be restored to design grades and geometry according to the approved plan. All drainage facilities will be constructed and maintained in accordance with the requirements of Title 14, CCR, Section 17778 and Title 23, CCR, Chapter 15, Section 2546(a). The drainage system inspection schedule is shown in Appendix J.

(C) A program to maintain and inspect the vegetative cover required for slope protection and erosion control pursuant to Title 14, CCR, Chapter 3, Article 7.8, Section 17779.

Slope protection and erosion control measures will be implemented in accordance with the requirements of Title 14, CCR, Section 17779 and Title 23, CCR, Chapter 15, Section 2581(c). Drainage channels will be lined with erosion control matting or rip-rap in critical areas. All final slopes of the landfill will be constructed to minimize erosion and to protect the integrity of the final cover. In addition, final cover surfaces will be vegetated with native plant species selected according to the following criteria:

- the rooting depth of the selected vegetation type will not exceed the depth to the top of the geosynthetic clay liner;
- the selected vegetation type will be tolerant of local environmental factors and the effects of landfill gas;
- the vegetation will be disease and pest resistant;
- the vegetation will be adaptable to the climate of the site; and,
- the vegetation type will be rapidly germinating and growing, self-propagating and persistent, will require low maintenance, and will provide a high percentage of surface coverage.

Final cover vegetation will be irrigated as necessary in accordance with Title 14, CCR, Section 17781 until sufficient plant growth has been established. The vegetative cover will be inspected during regular postclosure site inspections, according to the schedule presented in Appendix J. During the postclosure period, maintenance of the final cover will include fertilizing and reseeded any area that does not have acceptable vegetative cover. These areas will be identified and re-seeded with native vegetative species to restore vegetative growth.

(D) A program to inspect and maintain the leachate control system, implemented pursuant to Title 14, CCR, Chapter 3, Article 7.8, Section 17781.

The current design of the Walker Landfill calls for the utilization of the disposal area within the established existing waste footprint. As a result, a liner and leachate collection system will not be installed at the Walker Landfill.

(E) A program to maintain and inspect the gas monitoring network and gas control systems, implemented pursuant to Title 14, CCR, Chapter 3, Article 7.8, Section 17783, to ensure detection and control of migrating landfill gases.

As part of the closure construction activities at the landfill, gas monitoring probes will be installed around the perimeter of the site at an interval not to exceed one for every 1,000 feet laterally, and gas vents will be installed on the closure surface. Two gas monitoring probes, extending to five feet and 20 feet below ground surface, will be installed at each monitoring location. Waste fill depths are based on trench construction methods historically employed by Mono County site operators. Gas monitoring during the postclosure period will involve quarterly gas surveys to detect the presence of methane in the monitoring probes. At the property boundary, the concentration of methane gas will be monitored and will not exceed 5% by volume in air. Sampling for trace gases is not proposed at this time but may be recommended should high levels of methane be detected or at the direction of the LEA, CIWMB, or Air Pollution Control District (APCD). Monitoring of the probes will continue throughout the postclosure maintenance period on a quarterly basis. Sampling frequency may increase if methane is detected at levels greater than 5% at the property boundary. A decrease in the monitoring frequency may be proposed by Mono County if methane is not detected for an extended time during the postclosure maintenance period.

The results of the gas monitoring will be submitted to the CIWMB and LEA within 90 days of sampling, unless compliance levels are exceeded. The results will include the concentration of methane in each probe along with information involving the monitoring personnel and general conditions in which the sample was obtained. Should the compliance levels be exceeded, the CIWMB and LEA will be notified of the problem within five working days. Within 10 working days, a letter will be submitted describing the nature and extent of the problem.

Gas monitoring probes require no maintenance for adequate operation. However, each probe will be inspected at the time the gas surveys are undertaken to verify that each is in good operating condition. If any probes are found to be clogged or in need of repair, the appropriate parties will be contacted and any necessary corrective action will be taken.

(F) A program to inspect and maintain the ground water monitoring network, installed pursuant to Title 14, C.C.R., Chapter 3, Article 7.8, Section 17782.

The ground water monitoring system will be monitored throughout the period of postclosure to ensure the protection of public health and safety and the environment. The monitoring wells will be sampled on a semi-annual basis and tested for the presence of metals, minerals, and volatile organics. The owner or operator may petition for a decrease in the frequency of ground water monitoring if the results of a sufficient number of monitoring events indicates that the landfill has stabilized and will not pose a threat to public health and safety or the environment. Ground water monitoring will be performed in accordance with Title 14, CCR, Section 17782, Title 23, CCR, Chapter 15, Section (c)(3), and the WDRs established by the Lahontan RWQCB for the site.

Three ground water monitoring wells are installed at the Walker Landfill. A ground water monitoring program has been developed in conformance with the Solid Waste Assessment Test (SWAT) requirements for the site. The schedule and testing program included in Appendix C lists the frequency of testing and the parameters for monitoring.

The monitoring wells will be inspected during each sampling event. The surface seals, caps, and locking risers will be inspected. A summary of the inspection schedule is shown in Appendix J. The results of each ground water sampling event will be reported to the LEA, CIWMB, and RWQCB within 90 days after the sampling period has ended.

(G) A program to inspect and maintain the final grading at a site to prevent ponding and minimize infiltration.

The grading plan for the final cover has been designed in accordance with Title 14, Section 17776 and Title 23, CCR, Chapter 15, Section 2581(b). As discussed in the attached Preliminary Closure Plan, the final grades are designed to accommodate anticipated future settlement of the landfill and to reduce run-off velocities in order to protect the final cover from erosion. A settlement analysis was performed for the final configuration of the Walker Landfill, and is included in Appendix G. With the exception of the drainage channels, the final cover will be graded to a minimum three-percent grade and maintained to prevent ponding. Inspection and maintenance of the final grading will be performed in accordance with the procedures outlined in previous sections of this Preliminary Postclosure Maintenance Plan.

Five permanent settlement monuments will be installed in the final cover of the landfill; installation will be performed in accordance with Title 23, CCR, Chapter 15, Section 2580(d). Two additional survey control monuments will be installed in undisturbed, native soil near the eastern boundary of the site and will provide points for horizontal and vertical control during postclosure surveying. The approximate locations of survey and settlement monuments are illustrated on Drawing 3, Final Grading Plan. All monuments will be installed by a licensed land surveyor or a registered civil engineer. The monuments will provide a reference point from which the location and elevation of wastes and monitoring facilities can be determined throughout the postclosure maintenance period.

(4) Cost estimates pursuant to Section 18266 of this Article.

A detailed cost estimate for postclosure maintenance activities at the Walker Landfill have been prepared in accordance with Title 14, CCR, Section 18266. The preliminary postclosure cost estimate was calculated using a detailed cost estimating spreadsheet, which is included with the closure cost estimate presented in Appendix F of this report. The annual funding required for postclosure inspection and repairs is estimated to be \$26,300; the total expenditure for repairs throughout the 30-year postclosure maintenance period is estimated to be \$789,000.

The annual postclosure costs have been increased by 20 percent to account for potential cost overruns. The cost estimate enclosed in Appendix F addresses the inspection and repair of site facilities and environmental control systems, including access roads, site security, landfill gas and ground water monitoring systems, final cover and grading, drainage facilities, and vegetative cover.

Mono County has established a financial assurance mechanism based on a Pledge of Revenue agreement to ensure the availability of adequate funds for annual postclosure monitoring and maintenance at all County landfills. Documentation regarding the Pledge of Revenue agreement and applicable CIWMB approvals is provided in Appendix K of this Plan.

REFERENCES

- Edil, T.B., Ranguette, V.J., Wuellner, W.W., 1990, "Settlement of municipal refuse": in *Geotechnics of Waste Fills, Theory and Practice*, ASTM STP 1070, Baltimore, Maryland, p. 255-239.
- Kleinfelder, Inc., 1992, *Summary of May 1992 groundwater levels and water quality data for the Walker Landfill, Mono County, California*: unpublished report prepared for the Mono County Department of Public Works by Kleinfelder, Inc., Reno, Nevada, 4 p., 1 plate.
- Kleinfelder, Inc., 1989, *Final Report, Solid Waste Assessment Test, Walker Landfill, Mono County, California*: unpublished report prepared for the Mono County Department of Public Works by Kleinfelder, Inc., Reno, Nevada, December 1989.
- Triad Engineering Corporation, 1989, *Report of Disposal Site Information for Walker Landfill, Mono County, California*: unpublished report prepared for the Mono County Department of Public Works by Triad Engineering Corporation, Mammoth Lakes, California, March 1989, 23 p.
- Vector Engineering, Inc., 1992, *Source Reduction and Recycling Element for Mono County, California*: unpublished report prepared for the Mono County Department of Public Works, July 1992.
- U.S. Environmental Protection Agency, 1990, *Characterization of municipal solid waste in the United States: 1990 update*: U.S. Environmental Protection Agency, Solid Waste and Emergency Response, EPA/530-SW-90-042A, June 1990, 15 pp.



**REPORT OF DISPOSAL SITE
INFORMATION
WALKER LANDFILL (SWIS NO. 26-AA-0001)**

Prepared by:
Mono County Department of Public Works
74 North School Street
Bridgeport, CA 93517

January 1, 2015

**REPORT OF DISPOSAL SITE INFORMATION
WALKER LANDFILL
TABLE OF CONTENTS**

1.0	INTRODUCTION.....	6
2.0	FACILITY OVERVIEW.....	7
	2.1 Site Location.....	7
	2.2 Site Plan Description.....	7
	2.2.1 Surrounding Land Use	
	2.2.2 Facility Boundaries	
	2.3 Waste Source, Type and Volume.....	8
	2.3.1 General	
	2.3.2 High Liquid Content Wastes	
	2.3.3 Designated Wastes	
	2.3.4 Hazardous Wastes	
	2.3.5 Other Wastes Requiring Special Handling	
	2.3.6 Waste Volumes	
	2.4 Types and Numbers of Vehicles Anticipated to Enter the Facility.....	9
	2.5 Site Capacity.....	10
	2.6 Site Life Projection.....	10
	2.7 End Use of Site.....	10
	2.8 Airport Safety.....	11
3.0	REGULATORY REQUIREMENTS – PERMITS AND APPROVALS.....	11
4.0	DISPOSAL SITE DESIGN.....	11
	4.1 Figures and Design Plans.....	11
	4.1.1 Figures	
	4.1.2 Leachate Collection and Removal System	
	4.1.3 Surface Drainage Plans	
	4.1.4 Site Access Plan	
	4.1.5 Gas Management Plan	
	4.1.6 Groundwater Monitoring Plan	
	4.1.7 Representative Cross Section	
	4.1.8 Design Details	

4.2 Design Calculations.....	13
4.2.1 Site Capacity	
4.2.2 Soil Availability	
4.2.3 Seismic Stability	
4.2.4 Settlement Analysis	
4.2.5 Leachate Generation	
4.2.6 Drainage System Capacity Requirements	
4.2.7 Gas Generation and Air Emission Calculations	
4.2.8 Soil Erosion Analysis	
5.0 DISPOSAL SITE IMPROVEMENTS.....	15
6.0 DISPOSAL SITE OPERATIONS.....	16
6.1 Hours of Operation.....	16
6.2 Personnel.....	16
6.2.1 Minimum Numbers and Qualifications	
6.2.2 Training	
6.2.3 Supervision and Communication	
6.2.4 Safety Equipment	
6.2.4 Emergency Contact List	
6.3 Equipment.....	18
6.3.1 Minimum Equipment Requirements	
6.3.2 Standby Equipment	
6.3.3 Equipment Preventative Maintenance	
6.4 Material Handling Activities.....	19
6.4.1 Construction Sequencing	
6.4.2 Unloading	
6.4.3 Spreading and Compacting	
6.4.4 Special Handling Procedures	
6.4.5 Periodic Cover	
6.4.6 Intermediate Cover Placement	
6.4.7 Final Cover Placement	
6.4.8 Cover Availability	
6.5 Salvaging and Volume Reduction.....	22
6.5.1 Salvaging	
6.5.2 Storage of Salvage	
6.5.3 Removal of Salvage	

6.4 Non-Salvageable Items.....	23
6.5 Volume Reduction and Energy Recovery	
6.6 Health and Safety.....	23
6.6.1 Sanitary Facilities	
6.6.2 Potable Water	
6.6.3 Communications	
6.6.4 Lighting	
6.6.5 Safety Equipment	
7.0 DISPOSAL SITE CONTROLS.....	24
7.1 Leachate Management Plan.....	24
7.1.1 Leachate Control and Monitoring	
7.1.2 Vadose Zone Monitoring	
7.1.3 Groundwater Monitoring	
7.2 Gas Control and Monitoring.....	24
7.2.1 Monitoring System	
7.2.2 Gas Control or Recovery System	
7.2.3 Monitoring	
7.2.4 Gas Condensate Collection System	
7.2.5 Reporting	
7.3 Nuisance Control.....	25
7.4 Fire Control.....	25
7.5 Dust Control.....	26
7.6 Vector and Bird Control.....	26
7.7 Drainage and Erosion Control.....	27
7.8 Litter Control.....	27
7.9 Noise Control.....	27
7.10 Odor Control.....	27
7.11 Traffic Control.....	28
7.12 Hazardous Waste Screening Program.....	28
8.0 DISPOSAL SITE RECORDS AND REPORTING PROCEDURES.....	28
8.1 Weight/Volume Records.....	28
8.2 Subsurface Records.....	28
8.3 Special Occurrences.....	28

LIST OF FIGURES

Figure 1: Location and Vicinity Map

Figure 2: Site Plan

Figure 3: Land Use Map

Figure 4: Pre-Landfill Topography

Figure 5: Final Grading and Drainage Plan

Figure 5A: Cross Sections A-A' and 8-8'

Figure 6: Detail Sheet

Figure 7: Hydraulic Sub-Area Map

Figure 8: Typical Landfill Gas Probe Detail

LIST OF APPENDICES

Appendix A: Current Solid Waste Facility Permit

Appendix B: Site Life and Loading Rate Calculations

Appendix C: Landfill Gas Monitoring Plan

Appendix D: Load Checking Program

Appendix E: Record Keeping Forms

Appendix F: Emergency Contact List, Supervisory Structure and Minimum Qualifications

Appendix G: Traffic Volume Data

Appendix H: Waste Discharge Requirements

Appendix I: Well Boring Logs

1.0 INTRODUCTION

This Report of Disposal Site Information (RDSI) describes the design and operation of the Walker Landfill (WL) located in Mono County, California. This RDSI was developed originally in October of 1995 and was subsequently amended in 1997, 2001, 2004, 2006 and 2007. This revision is intended to incorporate and supersede all above amendments, and to reflect the most current information and data relating to the site, as of January 2015. The document thereby includes information from the 1995 RDSI, subsequent amendments, and current data that together form this updated and comprehensive RDSI.

Included in this RDSI are Figures that present the planned sequencing of disposal activities and the final configuration of the site.

The facility is operated under Solid Waste Facility Permit No. 26-AA-0001, issued to the Mono County Department of Public Works, located in Bridgeport, California. A copy of the Solid Waste Facility Permit for the WL is included in Appendix A. The site also houses the Walker Transfer Station (WTS) that operates under a separate EA Notification. WTS operations such as tonnage and traffic volumes are considered separately in that EA notification, and are not considered as a part of this RDSI for Landfill operations.

This RDSI has been prepared in accordance with Section 21600, Article 2, Subchapter 3, Chapter 4 of the California Code of Regulations (CCR) and describes the disposal site design, operations, controls, and record-keeping at the WL. Compliance with the contents of this RDSI is the responsibility of the County's Solid Waste Superintendent. The RDSI will be made available to employees involved in the daily operation of the landfill, as well to regulatory agency personnel and other parties upon request. Routine waste disposal and cover activities are performed by personnel and equipment from the Solid Waste Division of the Department of Public Works. When necessary, additional personnel and equipment are available from the Road Districts within the Department of Public Works.

Overall site planning, operations, and maintenance are administered by the Solid Waste Superintendent. Supervision of field personnel assigned to perform landfill tasks is provided by the Solid Waste Facility Supervisor. Both may be contacted through the Bridgeport office of the Mono County Department of Public Works at (760) 932-5440.

The WL, which was opened in 1970 to replace two open dumps in the region (Triad, 1989), is a Class III municipal solid waste landfill as defined by 27 CCR Section 20200. The facility is a combined landfill and transfer station accepting non-hazardous solid waste and construction and demolition waste from a service area that includes the communities of Walker, Coleville, and Topaz. In addition, waste is accepted from residents in the neighboring unincorporated areas of Douglas County, Nevada who have been issued non-resident permits by the Mono County Department of Public Works.

The site is classified as a Class III Landfill by the Lahontan Regional Water Quality Control Board (RWQCB), operating under Board Order R6T-2012-0025 (WDID No. 6A260012000). The Waste Discharge Requirements were revised in June of 2010 to reflect that the site no longer accepts municipal waste, and made adjustments to the water quality monitoring requirements accordingly.

A permanent split-level transfer station has been constructed on-site to manage the residential and commercial waste streams and related waste diversion efforts. The facility is operated under a separate EA Notification, and its operations are not considered as part of this RDSI for Landfill operations. The facility, which was constructed on native soil north of the landfill footprint, consists of a 45-foot truck scale, gatehouse, concrete tipping pad, concrete retaining wall, waste compactor, generator, 2 steel HHW lockers, a 500 gallon used oil tank, and paved roadways. Daily activities at the transfer station are performed under contract by D&S Waste, Inc. of Yerington, NV. Only inert debris and construction and demolition wastes remain onsite for disposal. Residential and commercial waste is processed through the transfer station and hauled off-site for disposal at either Mono County's Benton Crossing Landfill, or through D&S Waste transfer facilities in Nevada to Lockwood landfill. Other wastes requiring temporary on-site storage or stockpiling prior to processing, recycling or special handling (e.g., tires, white goods, scrap metal, wood and green waste, used motor oil, and household hazardous wastes) are managed through the transfer station.

Contact information for site operators is as follows:

Landfill Operator

Mono County Department of Public Works
Post Office Box 457
Bridgeport, California 93517
Phone: (760) 932-5440

Transfer Station Operator

D&S Waste Removal, Inc.
Post Office Box 834
Highway 95 East
Yerington, NV 89447
Phone: (775) 463-3090

The Local Enforcement Agency (LEA) will be notified in writing in advance of any changes to the name, address, or telephone number of the site operators. A copy of any notification will be maintained in the facility operating record located at the Bridgeport office of the Department of Public Works.

If modifications to the operational procedures described herein become necessary in the future, regulatory requirements shall be assessed to ensure that new or modified procedures satisfy compliance criteria. Prior to implementation, a description of revised waste management practices will be submitted to the LEA, RWQCB, and CalRecycle for review and approval. Approved modifications will be incorporated into the RDSI.

2.0 FACILITY OVERVIEW

The following section provides detailed information regarding the facility location, site plan description, waste source and types, vehicle traffic, site capacity and site life projections, and the end use of the site.

2.1 Site Location

The WL is located at latitude 38° 32' N and longitude 119° 27' W, on 43.5 acres of land in the Antelope Valley area of northern Mono County. The property is owned by the County of Mono and administered by the Department of Public Works. The site is approximately 2.5 miles northeast of the community of Walker, as illustrated on Drawing 1, Title Sheet and Location Map. The site address is 280 Offal Road, which is a County maintained paved road extending approximately one-third of a mile east from Eastside Lane.

2.2 Site Plan Description

Drawing 2, Existing Topography and Facilities, illustrates the pre-disposal topography of the site. The base topography was derived from the United States Geological Survey (U.S.G.S), Risue Canyon, California 7.5 Minute Quadrangle (1988).

2.2.1 Surrounding Land Use

The majority of land surrounding the landfill is publicly-owned and administered by the BLM. Bureau of Land Management lands in the region are defined as resource management and are used predominantly for recreation and livestock grazing. Land immediately adjacent to the landfill is zoned as ER, or estate residential, to the southwest, and as RM, or resource management in the remaining acres. To the west of the landfill property is a parcel zoned as LI, for light industrial. The landfill site is zoned for public or quasi-public facilities (PF) in the Land Use Element of the Mono County General Plan. Therefore, the use of the property as a municipal solid waste landfill is in agreement with local zoning ordinances.

2.2.2 Facility Boundaries

The total area of the site is 43.5 acres, of which approximately 10.4 acres (i.e., approximate Solid Waste Facility Permit [SWFP] waste footprint) are permitted for refuse disposal operations. The entire property is owned and operated by the DPW. The proposed final contours of the site, which provide the vertical grading limits of the landfill, have been designed to blend with the natural topography. The site has been constructed to reflect a minimal increase in the elevation of the site as related to the surrounding topography. The Final Grading and Drainage Plan (Figure 5) shows the property (facility) boundary, the 10.4 acre SWFP waste footprint, the 7.6 acre Subtitle D footprint, existing facilities, easements, access road and gate, and the buffer zones (those areas between the property boundary and the approximate disposal area footprint). The Site Plan (Figure 2) was developed from a base map showing topography from an aerial survey dated 2008, with updated topography of the refuse fill area from February 2013. As noted on the Site Plan (Figure 2), DPW will not dispose of any waste other than inert waste (as defined in 27 CCR, Section 20230) outside of the approximate 7.6-acre Subtitle D footprint without prior approval by the RWQCB.

2.3 Waste Source, Type, and Volume

In the past, the WL accepted mixed municipal refuse classified as Class III nonhazardous solid wastes, both putrescible (organic) and non-putrescible (inert) waste, as defined in 27 CCR, Sections 20220 and 20230. The mixed municipal waste generally consisted of residential and commercial wastes. Currently, mixed municipal refuse is not accepted at the WL; however, as described in Section 1.3, mixed municipal waste is currently processed through the WTS (which operates as a separate facility under an EA Notification, as discussed above) and hauled off-site for disposal at another permitted Class III landfill. Inert debris, C&D waste, and green waste are actively accepted at the WL and comprise the entirety of waste currently disposed on-site. Loads of mixed municipal waste (e.g., commercial and residential) may be landfilled at WL in the event that transfer station operations are temporarily discontinued due to unforeseen equipment breakdown, impassible road conditions, or for other unforeseen circumstances and would require advanced approvals from the RWQCB, LEA, and CalRecycle prior to landfilling any mixed municipal refuse. The WL does not accept waste tires, scrap metal, appliances, household hazardous waste, or universal waste for disposal; rather, the transfer station provides containers where such waste is temporarily stored until it is transported to the Benton Crossing Landfill for proper management.

A brief description of each of the major waste categories and how they are handled is presented below.

2.3.1 General

The WL is utilized by residents and commercial operations in Antelope Valley, the communities of Coleville and Walker, as well as the USMC Mountain Warfare Training Center at Pickel Meadows. All MSW and putrescible wastes are accepted by the WTS and transferred off site. The WL accepts inert construction and demolition waste, and inert green waste that do not require special handling procedures. Residential waste sources may include single and multi-family residences, hotels, motels, ranger stations, campgrounds, and recreation areas. Commercial wastes are those wastes which are non-industrial in nature and include solid waste generated by stores, offices, restaurants, warehouses, and other non-manufacturing activities. Construction and demolition debris includes wood wastes from land clearing, brush removal, and demolition activities, as well as gypsum board, asphalt and concrete debris. Green waste and organic waste includes landscaping and yard debris, manure, and clean soil. These wastes are accepted at the landfill within designated disposal or stockpile areas.

2.3.2 High Liquid Content Wastes

The WL does not accept liquid wastes from any source.

2.3.3 Designated Wastes

The WL does not accept designated wastes for disposal.

2.3.4 Hazardous Wastes

The WL does not accept for disposal any hazardous wastes as defined in 22 CCR Division 4.5. Small quantities of household hazardous waste are accepted or otherwise removed from the waste stream and temporarily stored in one of two hazardous waste lockers at the on-site transfer station. This waste is periodically transported to the County's permanent household hazardous waste facility (PHHWF), located at the Benton Crossing Landfill, for consolidation and proper packaging prior to removal by a licensed hazardous waste hauler.

A Load-Checking Program has been implemented at the WL to prevent acceptance of unpermitted waste. The Load-Checking Program is included in this RDSI as Appendix D.

Visual inspection of incoming loads is performed by the transfer station gate attendant, who evaluates each load before directing the customer to the appropriate disposal area, depending upon whether the waste is designated for transfer off-site, temporary on-site storage, or on-site burial. Visual inspection is also performed at the landfill working face during compaction and cover operations. Household hazardous waste identified and removed from incoming loads or the working face is temporarily stored in a containment unit on-site until it can be transported to the PHHWF operated by the County at the Benton Crossing Landfill. Gate attendants are routinely trained in procedures for load screening, conducting physical load inspections, and the proper handling and storage of hazardous wastes. The procedures developed for the hazardous waste screening program implemented at the site are discussed in further detail in Appendix D, and Section 7.12 of this RDSI.

2.3.5 Other Wastes Requiring Special Handling

The WL does not accept for storage or disposal any wastes which could create hazards or become a nuisance to public health and the environment (e.g., powdery or dusty materials). Wastes which require special handling are not accepted.

2.3.6 Waste Volumes

In 2012, approximately 340 tons of waste was received to the landfill. Of this waste, the majority was diverted with only 70 tons being landfilled. Due to the limited service area and nature of inert wastes, daily loading rates are highly variable at the WL. Although individual loads directed to the working face for burial are not large in quantity, with a daily average of approximately two tons per day on an annual average, the site may see spikes in activity over short periods depending upon the scope and frequency of local construction activities, road projects, or neighborhood clean-up efforts. Disposal quantities also vary widely depending on the time of year, with minimal disposal occurring between November and April and peaks typically taking place during the construction season of May through October. These factors, particularly local construction and demolition activities, may result in spikes of up to 50 tons per day.

Disposal quantities are determined by weighing each incoming load on the 45-foot truck scale operated at the transfer station; each vehicle is directed across the truck scale upon arrival and prior to departure to establish the net weight of waste delivered to the site.

2.4 Types and Quantities of Vehicles Entering the Facility

The WL serves a 25-mile corridor extending from the U.S. Marine Corps' Mountain Warfare Training Center at Pickel Meadows on Highway 108 in the south to the community of Topaz on the California / Nevada border in the north. The area is primarily residential and agricultural in nature, with a small commercial sector in Walker consisting of restaurants, motels, and stores. Public agency facilities in the service area include the Marine Corps Training Center, an elementary school and high school, an office of the Mono County Social Services Department, and Public Works' Road District 5 maintenance shop.

Two franchise haulers, Mammoth Disposal and D&S Waste Removal, provide waste collection service to residents and businesses in the Antelope Valley and roll-off debris box service to construction sites. Those who

do not subscribe to commercial collection service self-haul their waste to the Walker disposal site. Customers are typically comprised of residential and commercial self-haulers, construction contractors, and public agency personnel. Vehicles accessing the site range from personal cars and SUVs (with or without trailers) and pickup trucks to flatbed trucks and dump trucks. Large tractor-trailer style trucks, such as end dumps, do not typically utilize the facility. Commercial waste collection vehicles (i.e., packer trucks and roll-off trucks) do not use either the WL or WTS.

Traffic to the landfill is seasonal, with November through April traffic averaging 5 vehicles per day, and May through October averaging 11 vehicles per day. On an annual average, customers utilize the WL at a rate of fewer than three vehicles per day with a peak not exceeding 25 vehicles per day.

2.5 Site Capacity

The total permitted site capacity is 340,716 cubic yards, including in-place and remaining volumes for waste and cover soil.

The total remaining site capacity is the difference between the final grading plan (see Figure 5) and the current refuse fill grades (see Figure 2) (as of February 2013). The calculations of the remaining capacity were developed by a registered engineer and are included in Appendix B of the PCPMP. This Appendix presents the remaining site life/site capacity calculations for the site, which was approximately 114,337 cy as of February 2013 (the latest survey date of refuse fill area).

Using tonnage records from March 2013 through November 2014 and an estimate of December 2014, the remaining capacity for WL was calculated to be approximately 113,232 cy. Appendix B of the PCPMP also presents information regarding airspace, cover soil requirements, and remaining refuse capacity.

2.6 Site Life Projection

In order to calculate the site life for WL, the following criteria was utilized:

- Refuse-to-Cover Ratio: 2:1
- In-Place Refuse Density: 800lbs/cy
- Days of Operation: 103 days/year
- Growth Rate: Approximately 1%

Based on the above criteria, the WL will have a projected site life of approximately 350+ years from 2015. Based on these factors such as current refuse inflow rate assumptions, compaction rates, and technology, the site life of WL could extend to approximately 2380. However, the permitted estimated closure year will remain at 2120 since these factors are variable and subject to change.

A summary of site capacity and site life calculations is included in Appendix B of the PCPMP. Section 1.6.2.2 of the PCPMP also discusses factors affecting site capacity.

2.7 End Use of Site

The postclosure use of the Walker disposal site property will be a combination of open space for the landfill portion of the site and transfer station operations where they currently exist. The open space designation is consistent with surrounding land uses. All structures will be removed from the landfill portion of the site during closure construction activities, but transfer station structures will remain. The existing perimeter fence and locking entrance gate will remain in place and will be maintained throughout the postclosure maintenance period.

2.8 Airport Safety

There are no airports or landing strips located within one mile of site property boundaries. The nearest airport to the site is located in Bridgeport, approximately 34 miles to the south.

3.0 REGULATORY REQUIREMENTS - PERMITS AND APPROVALS

The WL is operated under authority of Solid Waste Facility Permit No. 26-AA-0001, issued by the Mono County Department of Health Services to the Mono County Department of Public Works. A copy of the permit is included in Appendix A of this RDSI. The landfill also operates pursuant to approved Waste Discharge Requirements per California Regional Water Quality Control Board Order R6T-2010-0025. The following agencies provide regulatory oversight and/or permit approval authority for the WL:

<u>Agency</u>	<u>Jurisdiction</u>
CalRecycle	Daily Disposal Activities
California Department of Toxic Substances Control	Hazardous Waste Mgmt.
Mono County Community Development Department	Land Use / CEQA
Mono County Department of Health Services	Daily Operations / CUPA
Lahontan Regional Water Quality Control Board	Waste Discharge Activities

4.0 DISPOSAL SITE DESIGN

This section of the RDSI describes the features incorporated into the design of the WL for environmental migration and regulatory compliance.

4.1 Figures and Design Plans

The Figures and Design Plans for the facility are illustrated in a variety of figures included with this RDSI and PCPMP. The following summarizes the basic elements of each figure. Additional figures, associated details and cross-sections can be found in the PCPMP.

4.1.1 Figures

Figure 1: Location and Vicinity Map

Figure 1 identifies the location of the WL in relation to State and boundaries and the local community.

Figure 2: Site Plan

Figure 2 delineates the site boundaries, existing topography, structures, and improvements. It also shows the Subtitle D waste footprint, disposal areas and stockpiling areas.

Figure 3: Land Use Map

Figure 3 shows the Land Use Designations (zoning) of the landfill site as well as surrounding areas, including a 1,000 foot radius around the site.

Figure 4: Pre-Landfill Topography

Figure 4 shows the topography of the landfill site and surrounding area, as determined by the USGS Risue Canyon 7.5 min. quadrangle, 1988.

Figure 5: Final Grading and Drainage Plan

Figure 5 shows the preliminary final grading contours, the SWFP waste footprint, and the related drainage plan for the site.

Figure 5A: Cross Sections

Figure 5A presents cross sections along two lines of section illustrated on Figure 5. The cross sections depict the grade of the final cover in relation to the pre landfill topography of the site.

Figure 6: Detail Sheet

Figure 6 includes design details for drainage features, as well as a profile of the proposed final cover construction.

Figure 7: Hydraulic Sub-Area

Figure 8: Typical Landfill Gas Probe Detail

4.1.2 Leachate Collection and Removal System

The WL was permitted under regulations that pre-date the requirement for the installation of liner and leachate collection systems. Therefore, no permanent leachate control systems have been installed at the facility. It is not anticipated that the site will expand laterally; however, any future lateral expansions at the site will be designed to comply with current regulatory requirements.

4.1.3 Surface Drainage Plans

The proposed drainage control systems for the final closure configuration are illustrated on Figure 5. Associated details of the proposed drainage structures are presented in the PCPMP on Figure 6. The drainage system has been designed to accommodate the anticipated volume of precipitation and peak run-off resulting from a 100-year, 24-hr storm event. A detailed description of the information on these plans is presented later in the disposal site control section of this document.

4.1.4 Site Access Plan

Figure 2, Site Plan, delineates the primary access road entering the landfill facility and includes access roads within the facility boundaries. The site is accessed by a paved road extending one-third mile east of Eastside Lane. Access roads within the facility and leading to the disposal areas are unpaved. Roads within the boundaries of the landfill will be periodically watered and graded as necessary to prevent fugitive dust generation.

4.1.5 Gas Management Plan

A Landfill Gas Monitoring and Control Program has been developed for the WL. The gas monitoring well network was installed in 2011, under the supervision of SRK Consulting. The LFGMCP, and related well logs, is included as Appendix C.

4.1.6 Groundwater Monitoring Plan

The WL currently has three wells for monitoring ground water quality (MW-1, MW-2, and MW-3). The up-gradient well (MW-2) monitors ground water that flows into the landfill area from the hydraulically higher portion of the drainage basin, and therefore provides background chemistry for constituents of concern. The down-gradient wells (MW-1, MW-3) monitors ground water that has passed beneath the refuse area and exited the landfill site, providing an early warning in the event of a contaminant release from the landfill. The monitoring wells were installed in May, 1988 under the supervision of Kleinfelder, Inc. A detection monitoring program was initiated at the site by Kleinfelder in June, 1988 beginning with the development of the monitoring wells. There have been several contractors who have performed groundwater monitoring at the site since the initial monitoring efforts. The consultant performing these services as of January 2015 is Team Engineering out of Bishop, CA.

Ground water is tested for the presence of metals, minerals, volatile organics, and general indicator constituents. The list of chemical constituents and monitoring frequency are dictated by the Waste Discharge Requirements established by the Lahontan RWQCB, included as Appendix H.

4.1.7 Representative Cross Section

Figure 5A presents cross sections along two lines of section illustrated on Figure 5. The cross sections depict the grade of the final cover in relation to the pre landfill topography of the site. Trench depth, as represented, has been approximated based on past operational practices at the site. Waste is placed and compacted to provide maximum utilization of the cells and to provide a working face configuration of 3:1 (horizontal to vertical) or less. During cover activities, refuse is spread downward in layers less than 24 inches in initial thickness, compacted with several passes of a track loader. A six-inch layer of clean cover soil is then applied over the waste surface.

4.1.8 Design Details

Design details are illustrated on Figure 6. Detail A is a profile of the proposed final cover construction. Detail B is a profile of the diversion drainage channel which will be constructed along the uphill side of the landfill. The channel will collect and route potential run-on flows around the final closed surface of the landfill and into the natural drainage course downstream. Detail C provides a profile of the proposed perimeter access road construction, including a profile of the perimeter drainage channel. Water falling on the sideslopes of the landfill cover is routed around the landfill in the perimeter drainage channel and then west along an internal access road, away from the final closed surface of the landfill. Water falling on the top surface of the landfill is directed downslope to the west, where it is intercepted by a headwall berm and directed west into a drop inlet. The drop inlet feeds a corrugated metal pipe (CMP) sideslope drain which routes run-off into the perimeter drainage channel and away from the landfill. Details G and H describe the sideslope drain which will channel run-off from the surface of the landfill into the perimeter drainage channel. A CMPT-section will disperse the energy generated in the sideslope drain and direct now into the perimeter drainage channel (Detail E).

The drainage control system at the WL has been designed to control the flow volume resulting from a 100-year, 24-hour storm event. Both storm water run-on and run-off will be collected and diverted into the natural drainage course downstream from the landfill. Drainage facilities will be constructed in accordance with the requirements of Title 14, CCR, Section 17778 and Title 23, CCR, Chapter 15, Section 2546(a).

Figure 8 details construction of the gas monitoring wells. The WL was permitted under regulations which pre-date the requirement for the installation of liner and leachate collection systems. Therefore, no permanent leachate control systems have been installed at the site. Lateral expansions which may be subject to the new solid waste regulations are not planned at this time.

4.2 Design Calculations

The following section describes the assumptions, procedures, and calculations used to determine design parameters for the WL.

4.2.1 Site Capacity

WL's permitted disposal area consists of approximately 10.4 acres within the 43.5-acre site boundary. The total permitted design capacity for WL is 340,716 cubic yards (cy), including in-place and remaining volumes for waste and cover soil. The total remaining site capacity is the difference between the final grading plan (Figure 5) and the current refuse fill grades (Figure 2) (as of February 2013).

The remaining site life/site capacity calculations for the site include approximately 114,337 cy as of February 2013 (the latest survey date of refuse fill area). Using tonnage records through September 30, 2013, the remaining capacity for WL was calculated to be approximately 114,169 cy.

4.2.2 Soil Availability

Readily available soil includes stockpiles from previous trench excavations, and clean soil received by the site. Additional on-site soil borrow sources are also available should soil stockpiles be depleted. This soil requires screening for use as cover, but is readily available along the eastern boundary of the site. The remaining soil stockpiles and on-site borrow sources should be sufficient for daily, intermediate, and final cover soil needs. Soil availability is discussed further in the PCPMP.

4.2.3 Seismic Stability

A slope stability analysis is required by 27 CCR, Section 21090 when the closure final grading design includes final exterior slope faces steeper than 3:1 (horizontal to vertical) or a geosynthetic component (e.g., GCL, geomembrane) are included as part of the final cover system (configuration). The proposed final slopes for the WL were designed to have a final fill gradient not exceeding 3:1. However, the final cover slopes will include a geosynthetic component (i.e., GCL or geocomposite liner) and a stability analysis was calculated. The stability analysis was completed for WL (see PCPMP Appendix E-1 for details). The stability analysis concluded that the final cover at the landfill is stable under static conditions. It should be noted that the Seismic Safety Element included in the Mono County General Plan indicates that the WL is not located in an area subject to liquefaction, nor is it located in an unstable area with poor foundation conditions.

4.2.4 Settlement Analysis

A prediction of the total waste settlement to be expected following closure of the site was performed in the Settlement Analysis (Vector Engineering, 1998) and included as Appendix E in the PCPMP. The prediction was based on a study by Edil, et.al. (1990), entitled *Settlement of Municipal Refuse*. The Power Creep Law, used extensively in modeling the transient creep behavior of engineering materials, was found to effectively represent actual waste settlement in the field; this is the method that was applied to the WL analysis. Waste input parameters for the model were taken from average data for the four sites examined in the study. Because the WL is located in an arid climate and would therefore be less susceptible to biological and chemical decay processes than the landfills examined by Edil (1990), it can be expected that the input parameters used in the settlement prediction will yield conservative results and that the actual settlement may be considerably less than predicted. In addition, with the conversion of landfill operations from municipal waste disposal to inert wastes only, settlements resulting from the effect of biological decay will be further minimized. The settlement calculations for the WL indicate that the maximum settlement expected for the 40 to 50 foot vertical expansion will be approximately 3.5 feet during the 30-year postclosure maintenance period. With proper maintenance, the predicted magnitude of settlement will not significantly affect the ability of the landfill slopes to promote drainage. In order to effectively monitor the settlement of the waste mass during the postclosure period, permanent settlement monuments will be installed on the top deck of the final landfill surface following closure construction. The settlement monument locations are depicted on Drawing 3, Final Grading Plan.

4.2.5 Leachate Generation

As described above, the WL was permitted under regulations which pre-date the requirements for a composite liner and leachate collection system. All future disposal operations will occur within the existing waste footprint, and will therefore not require the installation of a liner or leachate collection system. As a result, leachate generation predictions were not performed as part of the preparation of this RDSI.

4.2.6 Drainage System Capacity Requirements

Surface water drainage at the WL will be controlled by ditches, culverts, and interim drainage structures. Run-on and run-off control systems are designed, constructed, and maintained to prevent flow onto the active portion of the landfill during peak discharge from a 100-year, 24-hour storm event. Permanent drainage structures will be lined or vegetated as appropriate to prevent erosion. Run-on control systems will consist of a diversion drainage channel constructed north and east of the existing waste footprint. Run-off from the top surface and side slopes of the landfill will be collected and controlled in permanent drains that will convey water to the natural drainage course. During the development of the existing trench, temporary drainage systems will be installed to control run-off. Drainage facilities will be inspected monthly and any required maintenance will be performed to ensure that the system will function properly.

4.2.7 Gas Generation and Air Emission Calculations

In accordance with the California Calderon requirements, Category II air quality monitoring was performed in 1988 at five Mono County landfills. The WL was included in this monitoring. Tests performed include emissions screening, landfill gas tests, gas migration tests, and ambient air monitoring. Results of the analyses indicate that the WL does not produce a significant amount of landfill gas (Triad, 1989).

The WL does not have an area which has received final cover, and does not have a gas collection system. During construction of the final cover, a network of gas probes and vents will be installed on and around the site. Gas monitoring probes have been installed as directed in Appendix C, the Landfill Gas Monitoring and Control Program.

4.2.8 Soil Erosion Analysis

Intermediate cover slopes and the final landfill surface will be constructed to minimize erosion and protect the integrity of the cover. This will be accomplished through operational practices and by the establishment of vegetative cover. Soil loss and erosion will be minimized by maintaining relatively shallow slopes which are sufficient to promote drainage without enhancing the scouring effect of run-off. Vegetative species selected will require a minimum amount of maintenance and have a rooting depth which will not penetrate the infiltration barrier layer. The type of vegetation selected will also be based on the speed of germination and growth, the surface coverage, level of self-propagation, and resistance to environmental stresses such as disease and landfill gas. A Soil Loss Analysis (Vector Engineering, 1998) was performed to estimate of the potential soil loss that the WL may suffer during closure construction and the subsequent postclosure maintenance period. The results of the analysis, which was performed using the Universal Soil Loss Equation, have been included as Appendix G of the PCPMP. The analysis predicts a total soil loss of 8.88 tons per acre in the initial year of construction and 0.55 tons per acre for each subsequent year, or a total of 0.0074 inches from the landfill surface during the postclosure period.

5.0 DISPOSAL SITE IMPROVEMENTS

The WL itself does not have an operations office, but a skid-mounted, portable scalehouse is installed at the transfer station and serves as an office for both site operations. No permanent utilities are available on-site, so the gate attendant is provided with bottled water and a portable toilet is maintained by the transfer station operations contractor.

Although the scalehouse is not equipped with power, the truck scale, scale indicator, and printer are powered by an industrial generator located adjacent to the transfer station waste compactor. The site is operated only during daylight hours, so outdoor lighting is unnecessary.

Cellular telephones are assigned to the Solid Waste Superintendent and the Solid Waste Facility Supervisor; the scalehouse is also equipped with a cellular telephone by the transfer station operations contractor. In addition, two-way radios operated on the County's communications system are installed in County vehicles and all heavy equipment; these radios have the ability to switch between County frequencies as necessary, including that for the Benton Crossing Landfill, those for Public Works' four other channels, and those for emergency response agencies.

A four-strand barbed-wire fence is installed along the western and southern boundaries of the property, and a steep mountainside provides a geographic constraint for unauthorized access from the north and east of the site. Site access from Offal Road is controlled by an entrance gate constructed of steel tubing; the gate is locked except during site operating hours. Site access roads are constructed of compacted asphalt concrete road grindings to the transfer station and native soils consisting of decomposed granite and gravel from the transfer station to the landfill working face. Site soils are granular in nature and free of clay, which provides a suitable material as an all-weather surface for the landfill access road.

Site signs posted both at the entrance, at the scalehouse, and throughout both the landfill and transfer station operations areas provide customers with pertinent site information such as gate fees, disposal locations, and

prohibited waste warnings. The site entrance sign provides the days and hours of operation, holidays observed at the site, and contact telephone numbers for both the Department of Public Works, as site operator, and its transfer station operations contractor, D&S Waste. Additional facilities located at the transfer station consist of roll-off recycling bins for beverage containers and cardboard, a waste oil storage tank, and two secondary-containment lockers for temporary storage of household hazardous and universal wastes. With the exception of fixed structures such as the truck scale foundation and transfer station walls, slabs, and pavement, all facilities at the transfer station are temporary and portable.

6.0 DISPOSAL SITE OPERATIONS

The following section provides detailed information regarding the day-to-day operations of the WL, including the hours of operation, personnel requirements, equipment utilization, and waste handling procedures.

6.1 Hours of Operation

The WL is open to the public eight hours per day on Wednesdays and Saturdays. County personnel may be on-site during daylight hours on any day to perform routine activities, including snow removal, compacting and covering waste, generating and hauling cover soil, managing material stockpiles, processing diverted materials, and completing other maintenance tasks. The site observes four holidays per year, consisting of New Year's Day (January 1), Independence Day (July 4), Thanksgiving, and Christmas (December 25). The holidays and two operating days per week result in an operating schedule of approximately 100 days per year. Nobody is authorized to access the site on landfill holidays.

Public Landfill Operating Hours:

Wednesdays	7:30 am – 3:30 pm
Saturdays	7:30 am – 3:30 pm

6.2 Personnel

The Mono County Department of Public Works, Solid Waste Division, is responsible for day-to-day operations at the WL. As such, the department is responsible for ensuring that the proper staffing levels, personnel training, and supervision are available for the safe and uninterrupted operations at the site. Mono County contracts with D&S Waste Removal, Inc., for the daily operation of the transfer station located on the same property as, and to the north of, the landfill. The contractor is required to furnish sufficient personnel necessary to perform gate attendant functions, transfer truck operation, and staff supervision.

6.2.1 Minimum Numbers and Qualifications

The site is currently staffed with one gate attendant (furnished by the transfer station operations contractor) during hours the landfill is open to the public. County personnel from the regional landfill are used on an as-needed basis for stockpile management, materials processing, and removal of household hazardous and universal wastes. Personnel from Public Works' Road Division are available to provide maintenance to access roads and snow removal, as well as personnel from the Parks and Facilities Division to perform maintenance projects. Mono County arranges for independent contractors to perform sampling of ground water monitoring wells. Landfill tasks may require up to four employees depending upon the extent of the work to be performed, but routine waste compaction and cover activities are typically limited to one or two equipment operators. If necessary to fill in for absent landfill personnel, to complete site tasks, or to satisfy other operational requirements, personnel from any of the five Road Districts within the Department of Public Works are also available for temporary assignment on an as-needed basis.

The gate attendant is responsible for preparing and compiling gate transaction records, including gate receipts, and performing load-checking on incoming loads to prevent disposal of prohibited waste.

6.2.2 Training

Landfill personnel are trained in accordance with 27 CCR Section 20610 through a variety of means, including the following:

The Solid Waste Facility Supervisor conducts a monthly training meeting at the Benton Crossing Landfill, addressing landfill-specific topics such as proper equipment operation, traffic safety, handling difficult loads, working in dusty conditions, or responding to a landfill fire. The initial monthly session is followed up with three weekly tailgate meetings conducted by the Solid Waste Facility Supervisor on similar topics within the same subject.

All personnel are trained in the details of site-specific plans, including the *Injury and Illness Prevention Program* (IIPP), the *Emergency Response Plan*, and the *Load-Checking Program*.

The Solid Waste Facility Supervisor maintains certification in the California-specific version of the Management of landfill Operations (MOIO) training offered by the Solid Waste Association of North America (SWANA).

The Solid Waste Superintendent, or the Benton Crossing Solid Waste Facility Supervisor are responsible for training subordinates in site-specific operations; and, landfill personnel attend, when possible, other County training events (such as first aid, defensive driving, traffic control, first-responder, or hazardous waste operations training) to minimize overall program costs.

Documentation of personnel training is maintained in the operating record for the site at the Mono County Department of Public Works office in Bridgeport.

Transfer Station Contractor D&S Waste performs monthly training of employees, covering topics pertinent to site solid waste operations and maintenance, hazardous materials recognition and screening, use of mechanized equipment, environmental controls, emergency procedures and the requirements of Article 6.2. Records of such training history are maintained and available for inspection.

6.2.3 Supervision and Communication

The Solid Waste Superintendent is responsible for ensuring that County disposal sites are operated in compliance with State minimum standards and permit conditions. In addition, the Solid Waste Superintendent oversees the training program for personnel assigned to solid waste activities. Daily supervision and scheduling of landfill activities is provided by the Solid Waste Facility Supervisor. The organizational structure of the County's solid waste program, including contract operations and personnel assigned to each site, is presented in the flowchart included in Appendix F.

Communication at the site is provided primarily through cell phones. The Transfer Station operator is required to provide cell phones for the gate attendants on staff at WL. When Mono County staff is on site, many individuals carry County-issued cell phones and also possess radios in county vehicles.

6.2.4 Safety Equipment

In addition to the Personal Protective Equipment used by landfill staff as prescribed by the Injury Illness and Prevention Plan for the County Solid Waste Division, the Transfer Station contractor is required to provide emergency eye wash, a first aid kit, fire extinguisher and carbon monoxide detector for use by the gate attendant.

6.2.5 Emergency Contact List

The emergency contact list on the following page provides names, addresses, and telephone numbers for response personnel should there be an emergency at the WL. A detailed emergency contact list, a copy of which is enclosed in Appendix F, is posted in the gatehouse and is furnished to both the full-time gate attendant and the LEA.

<u>Contact Entity</u>	<u>Contact Person</u>	<u>Phone Number</u>
Department of Public Works <i>P.O. Box 457, Bridgeport, CA 93517</i>	Tony Dublino	(760) 932- 5440
Environmental Health Division (LEA) <i>P.O. Box 476, Bridgeport, CA 93517</i>	Louis Molina	(760) 932-5580
D&S Waste Removal, Inc. <i>P.O. 834, Yerington, NV 89447</i>	Kevin Brown	(775) 463- 3090
Antelope Valley Fire Protection District <i>1129 Larson Lane, Coleville, CA 96107</i>	Chief Mike Curti	(530) 495- 2900
Emergency - Mono County Sheriff		911

6.3 Equipment

The following section describes the type and quantity of equipment that is available at the WL for daily operations.

6.3.1 Minimum Equipment Requirements

The Solid Waste Facility Supervisor is responsible for ensuring that equipment sufficient in quantity and capacity is available to maintain safe and efficient waste management standards at the landfill. Equipment utilized for compaction and covering, grading, wood chipping, or completion of other projects at the WL is transported to the site on an as-needed basis by Road District personnel. Heavy equipment consisting of a bulldozer, two wheel loaders, two motor graders, two dump trucks, and water truck available from Public Works' Road District 5 (Walker) is utilized to perform routine waste compaction and covering activities and other operations at the WL.

6.3.2 Standby Equipment

Standby equipment is available from the Benton Crossing Landfill, from any of the County's five Road Districts, and from the Parks & Facilities Division, all of whom are divisions within the Department of Public Works. Heavy equipment available from these divisions include bulldozers, wheel loaders, motor graders, a scraper, water trucks, dump trucks, belly-dumps, low-boy trailers, backhoes, and road sweepers. If necessary, personnel are available from the other Public Works divisions to operate the heavy equipment. Small tools and other equipment are also available from these divisions, including welders, generators, compressors, pressure washers, chain saws, and hand tools. Heavy equipment can be rented from suppliers in Reno or Carson City, Nevada; hand tools and smaller equipment are available for rent from vendors in Mammoth Lakes, Bishop, and Gardnerville, Nevada. Cashman Equipment (Reno), which also has an office in Mammoth Lakes, is the most likely option for rental of heavy equipment.

6.3.3 Equipment Preventative Maintenance

Road District personnel are responsible for the regularly scheduled inspection and maintenance of all equipment. The inspection ensures that the equipment is in safe operating condition and that fuels and lubricants are maintained at proper operating levels. County mechanics perform minor repairs, parts

replacement, and preventative maintenance of landfill equipment either at the landfill, at the Road District 5 maintenance shop in Walker, or at the County's fleet maintenance shop in Bridgeport. All County on-road vehicles and off-road heavy equipment undergo a standardized maintenance program. Major repairs are typically performed by County mechanics at the Bridgeport fleet maintenance shop or, if necessary, by vendors in Reno, Nevada. If major repairs are required, the equipment is hauled by tractor-trailer by Road District personnel to its destination.

6.4 Material Handling Activities

Specifics regarding the handling of waste materials, including unloading, spreading, and compaction, are discussed in the following section.

6.4.1 Construction Sequencing

As of March 2014, landfill activities are contributing to a vertical expansion of the waste footprint according to the below diagram, in Area A. Once this area has reached a rough final grade, landfilling activities will proceed to area B, C, D, and E. The final Area F is within the 10.4 acre waste footprint, but it is currently occupied by the WTS. Waste would not be placed in Area F unless the WTS is abandoned or relocated. If it is determined that the WTS will remain in its current location, waste would not be placed in Area F and the Final Closure Plan would reflect this change. The working face in each area will move in the direction indicated below. These final lifts will vary in thickness, according to the recent site survey and available fill volumes shown in Appendix B. In the event that Mono County decides that a lateral expansion is necessary, plans and specifications regarding operations and construction sequencing will be submitted to the Mono County Local Enforcement Agency (LEA), CalRecycle, and the Regional Water Quality Control Board (RWQCB) for approval.

Fill Sequencing Diagram

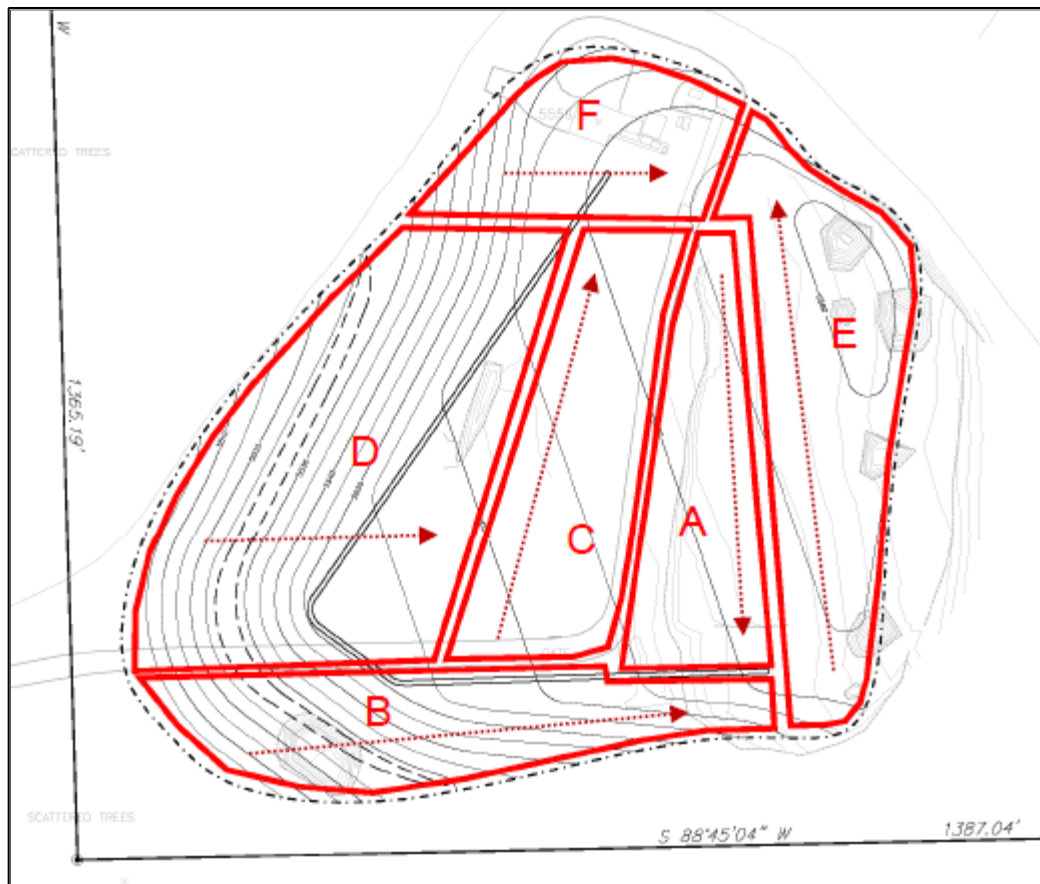

6.4.2 Unloading

Currently, waste designated for disposal is unloaded at delineated area adjacent to the active working face. The unloading area is approximately 60 feet wide. Wherever possible, bulky metal waste is removed from the waste and transported to Benton Crossing Landfill.

6.4.3 Spreading and Compacting

The WL currently utilizes a track dozer for waste compaction. Waste is placed and compacted in such a manner as to provide maximum utilization of the airspace and to provide a working face of 3:1 (horizontal to vertical) or less. Refuse is spread in layers approximately 24 inches in thickness before compaction. If compaction takes place on a slope, the refuse is spread and compacted from the base upward. The slope ratio is maintained at a 3:1 angle to achieve the maximum compaction with the equipment used. Each waste layer receives up to five passes with the compaction equipment. Compacted densities are estimated to approach 800 pounds per cubic yard after three to five passes with a track dozer. A six-inch layer of clean cover soil is then applied to the waste surface at the conclusion of cover activities. The size of the working face is maintained at a width of no more than 60 feet to afford optimum control of waste placement, compaction and cover application, and to minimize the attraction of vectors. At all times, a working face slope of 3:1 or flatter will be maintained, and waste will be spread and compacted from the base upward.

6.4.4 Special Handling Procedures

Hazardous and liquid wastes are not accepted at the WL. Construction and demolition debris such as concrete, asphalt paving, structural steels, wood materials, and other construction materials are placed at the base of the active face and compacted in lifts not exceeding four to five feet in compacted thickness. White goods and salvageable metal waste is segregated from the waste stream and processed through the transfer station for recycling. These wastes are temporarily stored in a debris box at the transfer station; when the box reaches capacity, it is transported to the Benton Crossing Landfill where the metal wastes are stockpiled until processing by a contractor prior to market delivery. Waste tires are temporarily stored in the same debris box at the transfer station as scrap metal and appliances are periodically hauled to the Benton Crossing Landfill. Tires are then removed from the debris box and stacked in a box trailer staged at the landfill until it reaches capacity. At that time, the County's contractor hauls the trailer to market. A similar procedure occurs with household hazardous wastes and universal wastes. This material is temporarily stored in metal storage sheds with secondary containment. County personnel from the Benton Crossing Landfill periodically collect the waste and transport it to the landfill where it is bulked and stored until processing and removal by a licensed contractor.

6.4.5 Periodic Cover

The Solid Waste Division currently arranges the equipment and personnel necessary for excavation and hauling of cover soil and the routine spreading, compaction, and cover of waste at the WL. A request for an alternative cover frequency (90 days) pursuant to 27 CCR 20680(f) received CalRecycle concurrence and was approved by the LEA on August 31, 2004. Due to decreasing waste volume, it is now proposed to perform cover activities of construction and demolition wastes two times per year at a minimum, not to exceed 180 days. Should the request be approved, cover activities would be scheduled during the first week of May and November and in the event that more than 30 tons of C&D waste accumulated between cover, additional cover activities would be scheduled to maintain an orderly disposal area.

6.4.6 Intermediate Cover Placement

Using the area fill method, intermediate cover is placed on the top of the waste lift as it progresses. The Solid Waste Facility Supervisor is responsible for evaluating cover needs. During cover activities, the waste is compacted in lifts not exceeding four to five feet in compacted thickness. Then, earthen material is placed and compacted to a depth of at least twelve (12) inches on all waste surfaces, in accordance with the approved cover frequency for the site, to control vectors, fires, odors, blowing litter, and scavenging.

6.4.7 Final Cover Placement

Several factors were taken into consideration in determining the final cover design for the WL, including the geometry of the existing landfill, local climatic conditions, potential landfill settlement, available final cover materials, desired performance criteria, erosion protection, vegetative growth, and end use at closure. Based on these parameters, it was determined that an alternative final cover design utilizing a geosynthetic clay liner (GCL) as the barrier layer component would be appropriate. Approval of alternative cover systems is allowed in 27 CCR, Section 20080(b) in cases where the discharger demonstrates that:

- (1) The construction of prescriptive standard is not feasible as provided in subsection (c) of Section 20080, and
- (2) There is a specific engineered alternative that:
 - (A) is consistent with the performance goal addressed by the particular construction or prescriptive standard, and
 - (B) affords equivalent protection against water quality impairment.

As stipulated in subsection (c) of Section 20080, to establish that the prescriptive standard is not feasible the discharger must demonstrate that the prescriptive standard:

- (1) is unreasonably and unnecessarily burdensome and will cost substantially more than alternatives which meet the criteria in subsection (b) of Section 20080; or
- (2) is impractical and will not promote attainment of applicable performance standards.

The proposed alternative final cover design will meet or exceed the prescribed performance criteria and will be more economical for site closure than prescriptive standards. An alternative final cover design will consist of the following (from bottom to top):

- a minimum 2-foot thick foundation layer (1-foot placed as intermediate cover);
- a GCL as a barrier layer;
- a geotextile drainage layer; and
- a minimum 18-inch thick vegetative layer containing no waste or leachate, placed on top of the GCL or drainage layer.

A typical cross-section of the alternative final cover system is shown on Figure 6. The proposed alternative final cover configuration has been designed to:

- Provide the containment of waste materials, preventing vectors (by people and animals) from interacting with the refuse mass;
- Limit additional moisture and air from entering the refuse to reduce the likelihood for fires below the final cover;
- Eliminate the potential for odors emanating from the landfill surface;
- Encapsulate the refuse prism to prevent any litter potential;
- Minimize the landfill gas generation potential, thereby reducing migration potential, and,
- Provide for an aesthetically pleasing open-space appearance, consistent with postclosure land use guidelines.

Approval of this design by the RWQCB is required prior to implementation of this alternative final cover system. DPW will notify the RWQCB, the LEA, and CalRecycle of changes to the borrow sources and related costs, if any.

6.4.8 Cover Availability

Final cover soil sources for the landfill include on-site soil borrow areas (eastern portion of the existing waste footprint) and stockpile areas.

6.5 Salvaging and Volume Reduction

Salvaging and scavenging by the public are not allowed at the WL, as specifically stated on the site entrance sign. Segregated stockpile areas for demolition materials and white goods are established at the site; the public is directed to these areas with signs. The policies for salvaging and volume reduction are discussed below.

6.5.1 Salvaging

Salvaging by the public is currently not allowed at the WL. Salvaging procedures are carried out by the landfill attendant and include the segregation of white goods and bulky metal wastes from the waste stream, as necessary. These wastes are stockpiled in a designated area of the landfill and are periodically transferred to the Benton Crossing Landfill. Clean wood waste is processed on site, and made available for public re-use.

In an effort to achieve additional diversion, the county is considering the development of a Materials Salvaging Plan. If the plan is eventually adopted, a copy would be forwarded to the LEA and included within this RDSI. The draft plan describes the procedures to assure the activities would be conducted in a planned and controlled manner.

6.5.2 Storage of Salvage

White goods and metal wastes are temporarily stored in an open top 40 yd roll-off bin, located at the Transfer Station, until the bin is eventually transported off-site and recoverable materials are separated and recycled.

Should the county adopt a Materials Salvaging Plan, the plan would delineate an area and method for the temporary storage of salvageable items.

6.5.3 Removal of Salvage

Metal waste and white goods are stockpiled on-site and transferred off-site as necessary. There is no inherent fire hazard associated with this type of waste. Such unprocessed materials are stored for a period not to exceed one year. Processed materials such as crushed aggregate and wood chips are stockpiled on site until they are beneficially re-used. Records of removal frequency for each type of material are maintained by the operator.

6.6 Non-Salvageable Items

Salvaging by the public is not allowed at the WL. The landfill attendant is responsible for ensuring that items are not salvaged by the general public. The landfill attendant will not salvage, or allow to be salvaged, any drugs, cosmetics, food, beverages, hazardous chemicals, poisons, medical wastes, syringes, pesticides, or any other item which may cause a health or safety problem.

6.7 Volume Reduction and Energy Recovery

There are no other programs planned for volume reduction or energy recovery at the WL.

6.8 Health and Safety

The following section describes the facilities and conveniences which will be provided at the landfill for personnel and the general public, including sanitary facilities, a potable water supply, communications equipment, lighting, and safety equipment.

6.8.1 Sanitary Facilities

A portable sanitary facility will be provided for site personnel. Records of toilet facility service by a licensed pumping company shall be maintained at the landfill or County offices and made available for inspection upon request.

6.8.2 Potable Water

Potable water will be provided for site personnel. The water supply will consist of bottled water, will be maintained in the gatehouse, and will comply with minimum Health Department requirements.

6.8.3 Communications

During the hours of operation, the landfill attendant will be equipped with a cellular phone. Although the phone is not intended for routine public use, it will be made available to the public for emergency purposes. In addition, all county vehicles are equipped with two-way radios which are dispatched through the base station at the Mono County Road Department.

6.8.4 Lighting

Landfill operations are conducted only during daylight hours.

6.8.5 Safety Equipment

Fire extinguishers are mounted on each piece of heavy equipment and in each County vehicle. An additional fire extinguisher and a first aid kit will be mounted in the gatehouse. Landfill personnel are trained in the use of each of the four basic types of fire extinguishers.

7.0 DISPOSAL SITE CONTROLS

The following section provides a detailed review of site controls relating to the following: leachate management; vadose zone, ground water, and landfill gas monitoring; nuisance, fire, dust, and vector control; drainage, erosion, litter, noise, odor, and traffic control; and, hazardous waste screening.

7.1 Leachate Management Plan

The WL was permitted under regulations which pre-date the requirement for the installation of liner and leachate collection systems. Therefore, no permanent leachate control systems have been installed within the disposal boundaries. Future municipal waste disposal activities will be confined to the existing waste footprint, and therefore, will not require the installation of a liner or leachate collection system.

7.1.1 Leachate Control and Monitoring

The WL does not have a leachate control and monitoring system. Future disposal activities will be confined to the existing waste footprint, and will therefore not require the installation of a liner or leachate collection and monitoring system. Should surfacing leachate be detected during the course of cover activities or quarterly inspections, the public will be excluded from these areas by fencing the area with caution tape. The tape shall establish a perimeter no less than 50' around the area.

7.1.2 Vadose Zone Monitoring

The vadose zone monitoring system is described in the Landfill Gas Monitoring and Control Program, included as Appendix C.

7.1.3 Groundwater Monitoring

The WL currently has three wells for monitoring ground water quality (wells MW-1, MW-2, and MW-3). The up-gradient well (MW-2) monitors ground water that flows into the landfill area from the hydraulically higher portion of the drainage basin, and therefore provides background chemistry for constituents of concern. The down-gradient wells (MW1, MW-3) monitor ground water that has passed beneath the refuse area and exited the landfill site, providing an early warning in the event of a contaminant release from the landfill. The monitoring wells were installed in May, 1988 under the supervision of Kleinfelder, Inc. A detection monitoring program was initiated at the site by Kleinfelder in June, 1988 beginning with the development of the monitoring wells.

The monitoring program is intended to determine both background and down-gradient concentrations of indicator parameters and leachate constituents. Ground water is tested for the presence of metals, minerals, volatile organics, and general indicator constituents. The monitoring frequency, and specific chemical constituents being monitored, are dictated by the RWQCB's Waste Discharge Requirements, included as Appendix H.

The site ground water monitoring wells MW-1 and MW-3 are constructed using 4 inch diameter, Schedule 40, flush-threaded PVC casing. Monitoring well MW-2 is constructed using 5 inch diameter PVC casing. The screened sections of the monitoring wells were completed using machine-slotted well screen equipped with 0.020 inch diameter slots. The annular space opposite the screen section was filled with Monterey #3 clean sand. Bentonite pellets were placed at the top of the sand pack. The remaining annular space was grouted with a cement/bentonite mixture. The boring logs are reproduced in Appendix I and illustrate the well construction and soil types for each well. Well locations are illustrated on Figures 2 and 3.

7.2 Gas Control and Monitoring

The Landfill Gas Monitoring and Control Program is included as Appendix C, and describes the existing gas monitoring well network, and methods.

The WL does not have an area which has received final cover, and does not have a gas collection or control system. During construction of the final cover, it is expected that an additional network of gas vents, and perhaps additional probes, will be installed on and around the site.

7.2.1 Monitoring System

The Landfill Gas Monitoring and Control Program was designed by a registered civil engineer and is included as Appendix C.

7.2.2 Gas Control or Recovery System

The Landfill Gas Monitoring and Control Program is included as Appendix C and describes the existing gas monitoring well network, and monitoring methods. At the present time, there is no landfill gas control or recovery system at the WL. At such time that a gas control or recovery system is required and installed, landfill gas will be extracted through an approved recovery system.

7.2.3 Monitoring

Gas monitoring will be performed on a quarterly basis during the operational life of the landfill, and during the postclosure maintenance period. Monitoring will continue for a period of thirty years after the final receipt of waste in accordance with the plan described in the PCPMP.

7.2.4 Gas Condensate Collection System

At the present time, there is no landfill gas condensate collection system at the WL. At such time that a gas collection system is required and installed, gas condensates will be extracted through an approved collection system.

7.2.5 Reporting

The results of the gas monitoring will be submitted to the LEA within 90 days of sampling, unless compliance levels are exceeded. The results will include the concentration of methane in each probe, together with information regarding the personnel and general conditions in which the sample was obtained. Should the compliance levels be exceeded, the LEA will be immediately notified of the problem. Within 7 (seven) working days, results will be verified and a letter will be submitted to the LEA, and placed in the operating record for the facility that describes the levels of methane and trace gas detected, a brief description of the nature and extent of the problem based on information currently available, the steps taken to protect public health and safety and the environment, and a brief description of any further corrective actions that the operator or others need to take to adequately protect public health and safety and the environment.

7.3 Nuisance Control

There have been no complaints from residents regarding the landfill operations. The nearest dwelling in the vicinity of the landfill is one-half mile from the landfill. The landfill is characterized as a low use rural landfill, and all landfill operations are performed during daylight hours. The use of heavy equipment at the site is limited to compaction and cover soil application on a quarterly basis, and occasional maintenance needs. As a result, very little noise is generated from daily operations. Due to the rural nature and relatively small size of the WL, the site will not create a public nuisance and will be operated in compliance with all existing regulations.

7.4 Fire Control

The following fire prevention measures are executed at the WL:

Combustible materials are restricted at the facility. Combustible liquid wastes are prohibited, and soils contaminated with petroleum products will not be accepted. Load inspection and identification practices are discussed in the hazardous materials section of this RDSI.

Open burning of materials is prohibited at the WL.

Deposited wastes are covered in accordance with the approved method and frequency, and compacted to a density of approximately 800 pounds per cubic yard. Cover and compaction will reduce the air spaces in which explosive gases can accumulate, thus decreasing the risk of explosive gas migration or ignition.

Separation between stockpiles of combustible materials such as wood waste and organics shall be maintained at no less than 40 feet between piles, and piles themselves shall not exceed 40 feet in any direction.

Spark arresters are used on all equipment, including heavy machinery and support equipment.

The gatehouse conforms to all applicable building codes and is equipped with a fire extinguisher.

Landfill personnel are prepared to provide immediate fire suppression in the event of a fire at the active face or within a structure. Fire extinguishers are mounted on all site equipment and County vehicles. In the event of a fire at the active face or within the waste mass, stockpiled cover soils will be used to smother the burning or smoldering area. Water will not be applied to the active face unless absolutely necessary. In the event of an uncontrolled fire, or a fire that cannot be managed by on-site personnel, the local volunteer Fire Department or the Mono County Road Department will be contacted. On arrival at the facility, the Fire Department will assume responsibility for continued fire abatement activities. Due to the open area of the facility, access roads and perimeter ditches will effectively serve as fire breaks around the site. An entry will be made into the operating record of all fires occurring at the site. The record will state the date and time the fire is reported, location of

fire, suspected cause of fire, measures used to control the event, reported accidents or injuries sustained in suppressing the fire, and whether an emergency response team was dispatched to the scene.

The WL operates in full compliance with California Department of Forestry fire safety requirements. A minimum distance of 20 feet is kept clear around all piles and disposal areas, and all internal and external access roads are properly maintained to allow for the passage of emergency vehicles.

7.5 Dust Control

Water will be applied by a water truck on an as-needed basis to the facility access roads, haul roads, and borrow areas, and will reduce or prevent fugitive dust generation. In addition, heavy equipment operation will be suspended during periods of high winds.

7.6 Vector and Bird Control

As all putrescible waste is processed in the Transfer Station compactor, vectors and birds are not a significant problem at the WL. Nonetheless, the occasional nuisance has developed, and mitigation plans were developed as the issues begin to interfere with normal daily operations of the landfill. Examples of these developing nuisances and responding mitigations are discussed below.

In the height of the summer, snakes have been observed near and around the piles of wood waste. Signs have been placed to caution the public about this danger, and to encourage avoidance. If the sightings become a daily occurrence, landfill staff is sent to the site to either perform shredding of the piles, or to move the piles around the site in a way that disrupts the available harborage.

Bears have not presented a problem at the landfill, but have been attracted to the Transfer Station by the odor of putrescible waste. The compactor is designed in such a way that it leaves a small access path between the piston and the compactor bin, which bears have successfully reached into and removed garbage. This success has brought them back time and again, occasionally during business hours, which has created some issues.

With guidance from the Department of Fish and Game, staff fabricated a steel gate that is now lowered onto the compactor when the transfer station is closed, removing the possibility that bears can access garbage. It is anticipated that the "removal of the reward" will eliminate the bears visits, and disturbance to the site.

7.7 Drainage and Erosion Control

Surface water drainage at the WL will be controlled by ditches, culverts, and interim drainage structures. Run-on and run-off control systems are designed, constructed, and maintained to prevent flow onto the active portion of the landfill during peak discharge from a 100-year, 24-hour storm event. Permanent drainage structures will be lined or vegetated as appropriate to prevent erosion.

Run-on control systems will consist of a diversion drainage channel constructed north and east of the existing waste footprint. Run-off from the top surface and side slopes of the landfill will be collected and controlled in permanent drains that will convey water to the natural drainage course. Drainage facilities will be inspected quarterly and any required maintenance will be performed to ensure that the system will function properly. Soil loss and erosion will be minimized by maintaining relatively shallow slopes which are sufficient to promote drainage without enhancing the effects of erosion. Landfill slopes will be revegetated with native grasses during closure construction, which will reduce the effects of erosion by wind and water.

7.8 Litter Control

The WL will control windblown debris through a variety of means, including: routine litter cleanup activities, and cover and compaction of the active dumping area.

Should litter become a problem, portable litter control fences may be used. The fences would be positioned near the active working face in a location determined by wind direction in order to contain debris that may be blown from the area.

Windblown debris collected by the perimeter fences and immediate land areas will be picked up and properly disposed of on an as-needed basis (litter collection frequency will be increased during high wind periods).

Access and perimeter roads will be patrolled on days the site is open to the public, and picked for windblown litter in order to maintain an aesthetically pleasing and healthy environment at the facility. Litter control at the facility will be performed by gate attendants and landfill personnel. If litter is blown from the facility to surrounding properties, either facility staff or part-time laborers will be used to collect litter on a regularly scheduled basis. Due to the nature of inert waste, litter problems are not expected to arise from the active disposal area at that time.

7.9 Noise Control

The majority of noise generated at the WL is the result of heavy equipment operation during daily spreading, compaction, and cover activities. The generation of noise at the facility is not anticipated to pose a health hazard to site personnel nearby residents or persons using the facility. Equipment operators will be provided with ear plug or other devices designed to minimize the risk of hearing impairment. As previously mentioned, the nearest occupied residence is one-half mile from the landfill. This distance will attenuate some of the landfill noise before it reaches the nearest residence.

7.10 Odor Control

The potential for on-site generation of odors is minimal because only non-putrescible inert wastes are received and stockpiled at the site. All putrescible waste is processed through the compactor, and transported off-site at least once per week. In addition, due to the relatively remote location of the landfill property, any odors which may be noticeable at the landfill facility will not affect surrounding residences.

7.11 Traffic Control

Traffic is controlled at the landfill by the use of on-site directional signs which indicate the location of the active face and different segregated areas. In addition, verbal direction is provided to haulers by the site attendant. Due to the remote location of the landfill facility, traffic problems have not been, and are not anticipated to be, a significant problem. Access to the site is provided year round by the County-maintained access road. Snow removal from the access road is performed by the County during the winter months.

7.12 Hazardous Waste Screening Program

The WL operates according to a Load Checking Program, included as Appendix D.

8.0 DISPOSAL SITE RECORDS AND REPORTING PROCEDURES

Pursuant to the requirements of Title 27, CCR, sections 20510 and 20515 as well as Title 14 sections 17414 and 17414.1, landfill operators are required to maintain operating records to document site disposal rates, excavation quantities, and special occurrences. These records are to be made available upon demand to authorized representatives of the LEA, CalRecycle, RWQCB, and other authorized agencies. The types of records to be maintained, and the record-keeping procedures implemented at the site are described in the following section.

8.1 Weight/Volume Records

Incoming waste volume at the WL is currently recorded by Daily Gate Receipts that are generated by the gate attendant after weighing each load upon entry and exit from the facility. This provides an accurate account of

the total tonnage received at the site, both at the Transfer Station and Landfill. A copy of the Daily Gate Receipt form is included in Appendix E, Record Keeping Forms.

8.2 Subsurface Records

The current method of disposal at the site is a vertical expansion using the area-fill method. No cuts in natural terrain are planned at the site at this time.

8.3 Special Occurrences

The gate attendant is required to document all special occurrences that take place at the landfill site. The records will be maintained at the landfill; records will periodically be transferred to the Department of Public Works office. The landfill attendant will maintain logs of waste disposal volumes, hazardous waste discharges, fires or earth slides, unusual settlement, explosions and any injuries or damage which may have occurred at the WL. The special occurrence records will state how the following occurrences were addressed or administered if any occurred:

Fires: The landfill attendant will record the area the fire occurred, the possible cause of the fire and measures taken to extinguish the fire (i.e., hand-held fire extinguisher was used to put out the flames, heavy equipment and soils were used to smother the flames, or the local fire department was called to extinguish the fire) . The landfill attendant will notify the Fire Department and the Director of Public Works of the incident.

Earth Slides: List all earth slides which have occurred at the site. The attendant will also note any damages or injuries which may have occurred due to the slide and measures taken to ensure the public safety from the slide. The landfill attendant will also notify the Director of Public Works of the incident.

Unusual or Sudden Settlement: A log of sudden settlement of the existing and previously filled areas of the landfill will be kept. The attendant will note the date and time of occurrence, the possible cause of the settlement, and measures taken to ensure public safety (i.e., cordon off area from the public, provide soil and compaction to the settled area). The landfill attendant will also notify the Director of Public Works of the incident.

Injury and Property Damages: A record must be kept of all injuries and damages to both the operations personnel and the general public which have occurred at the landfill. The operator will record the extent of the injury, possible cause of the injury, and actions taken for the health and safety of the injured person. Vehicle accidents which occurred at the site from the use of heavy equipment or between private vehicles will be recorded. The landfill attendant will also notify the Director of Public Works of any incidents which involve the operators equipment and personnel;

Explosions: Any explosive releases which occur at the facility will be listed. The landfill attendant will note the date and time of the explosion, what circumstances caused the discharge, and actions taken. If an explosion has occurred, the attendant will immediately restrict access to the area, remove personnel and equipment, and prevent the general public from entering the area. The attendant will also notify the fire department and the Director of Public Works at the time of the incident. Should an explosion occur at the disposal site, the attendant will direct all incoming wastes to an alternate disposal area, or provide an alternative disposal location and possible transportation to the location.

Discharge of Hazardous Waste: All incoming waste loads will be inspected for unauthorized and hazardous wastes prior to entering the disposal area. The landfill attendant will comply with the hazardous waste screening program described above.

Flooding: In the event that flooding occurs at the WL facility, the landfill attendant will make a record in the special occurrences log book of the date and time, source of the flooding, areas affected by the occurrence, and actions taken to alleviate the problem. The landfill attendant will notify the Director of Public Works of the incident. Should a flood occur at the Walker site, the attendant will direct all incoming wastes to an alternate disposal area, or provide an alternative disposal location and possible transportation to the location.

FIGURES

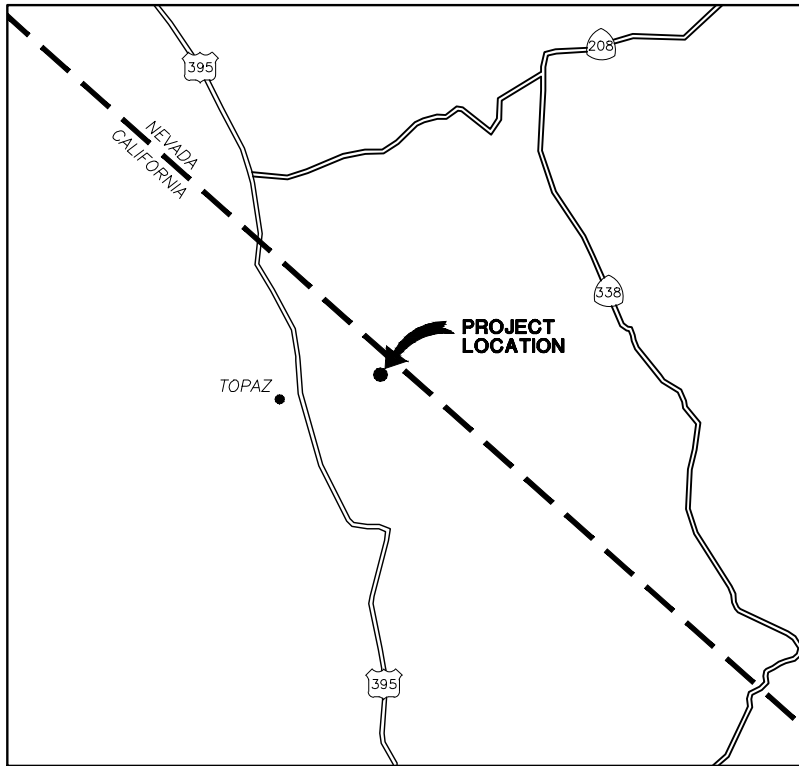

VICINITY MAP

SCALE: 1"=8 MI

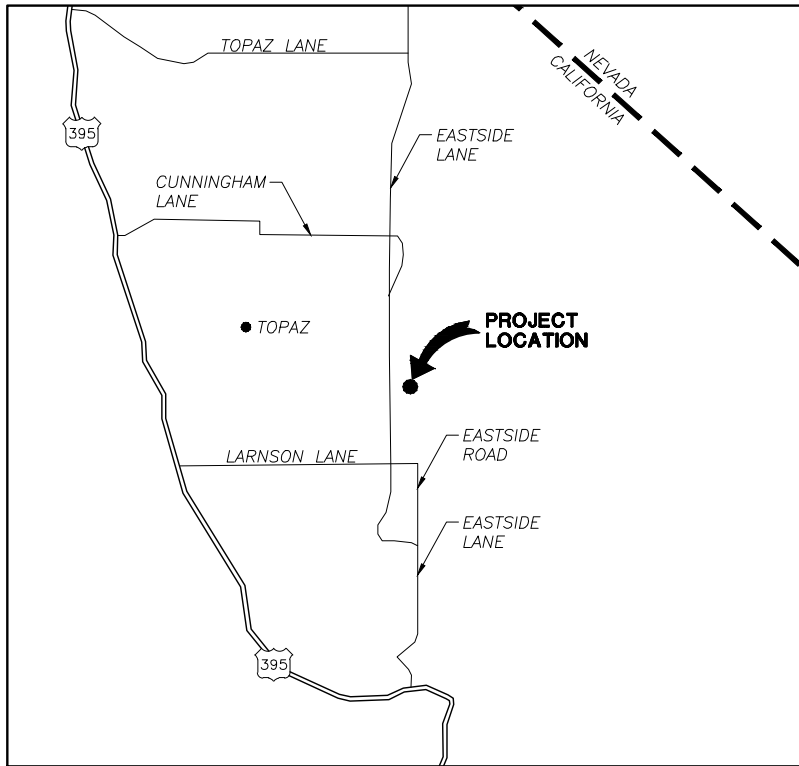

LOCATION MAP

SCALE: 1"=10,000 FT

FIGURE 1

PREPARED BY:



800-C SOUTH ROCHESTER AVENUE
ONTARIO, CALIFORNIA 91761

MONO COUNTY - WALKER LANDFILL
PCPCMP
LOCATION AND VICINITY MAP

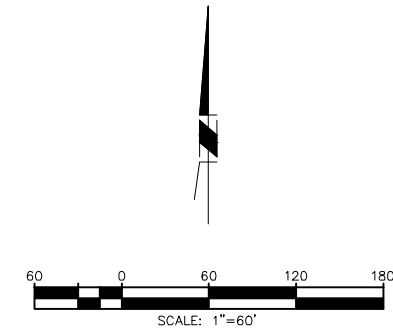
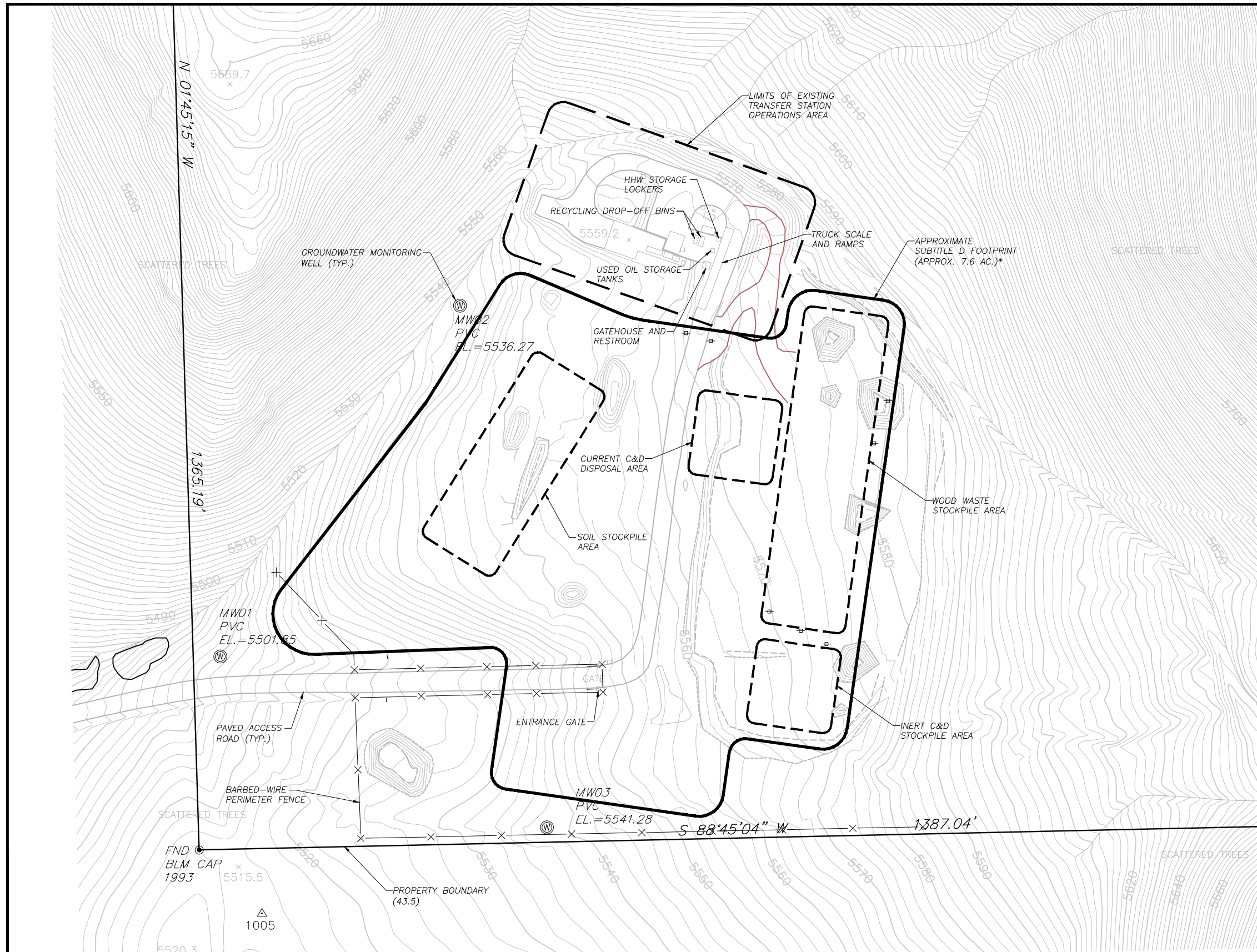

LEGEND

5700	EXISTING CONTOUR ELEVATION
⊙	GROUNDWATER MONITORING WELL
—	PROPERTY BOUNDARY
—x—	FENCELINE
—	ROAD
—	PROPERTY BOUNDARY
—	APPROXIMATE SUBTITLE D FOOTPRINT*

*THE COUNTY WILL NOT DISPOSE OF ANYTHING OTHER THAN INERT WASTES (AS DEFINED IN 27 CCR, SECTION 20230) OUTSIDE OF THE 7.6-ACRE APPROXIMATE SUBTITLE D FOOTPRINT WITHOUT PRIOR APPROVAL BY THE RWQCB.

PREPARED BY:
SWT Engineering Civil & Environmental
 800-C SOUTH ROCHESTER AVENUE
 ONTARIO, CALIFORNIA 91761

FIGURE 2

MONO COUNTY - WALKER LANDFILL
 PCPCMP
 SITE PLAN

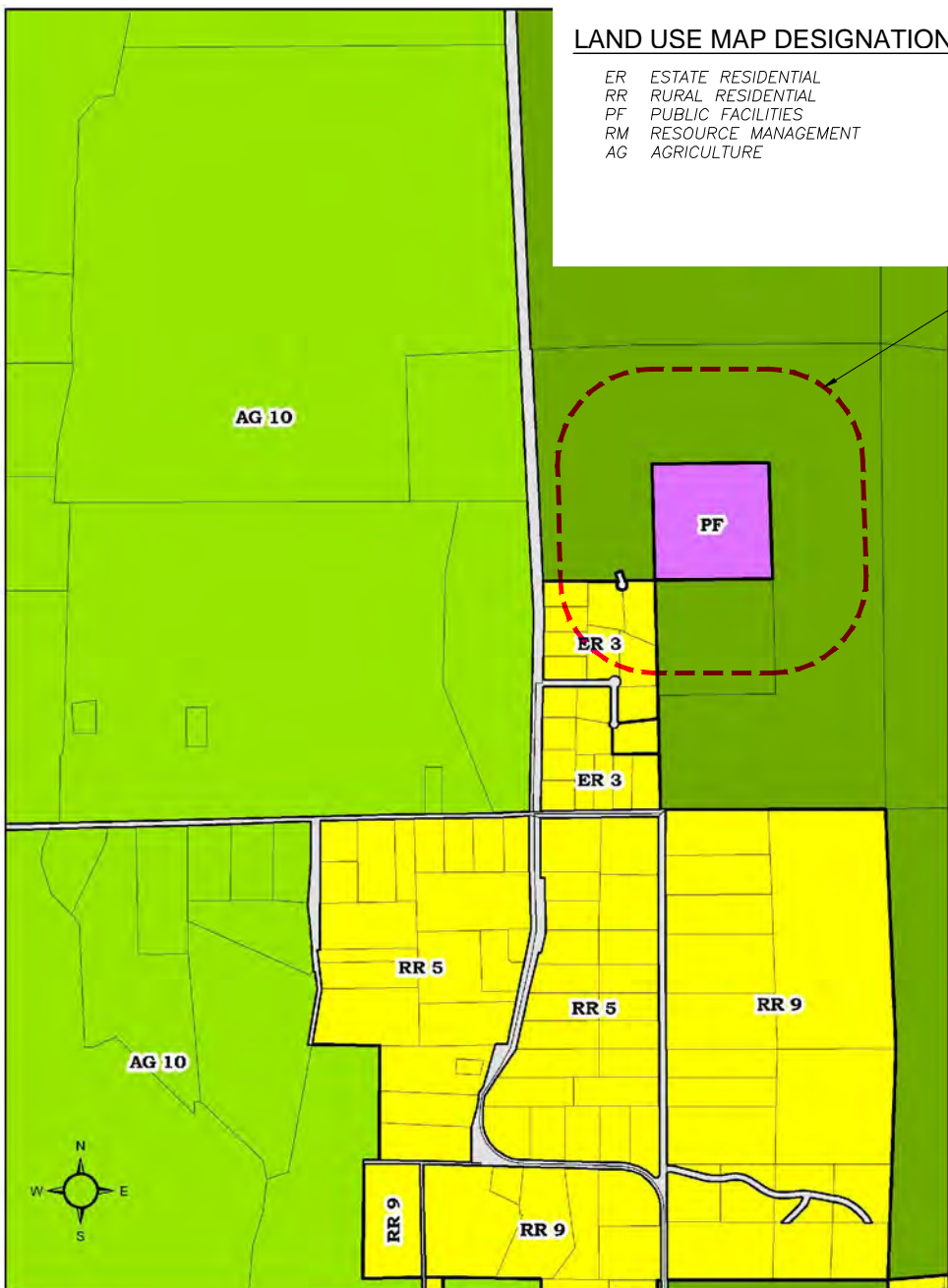

LAND USE MAP DESIGNATIONS:

- ER ESTATE RESIDENTIAL
- RR RURAL RESIDENTIAL
- PF PUBLIC FACILITIES
- RM RESOURCE MANAGEMENT
- AG AGRICULTURE

1,000 FT RADIUS



SCALE: 1"=2,000 FT

Source: Mono County
General Plan, 2013
Land Use Element

FIGURE 3

PREPARED BY:
SWT Civil & Environmental
Engineering 
800-C SOUTH ROCHESTER AVENUE
ONTARIO, CALIFORNIA 91761

MONO COUNTY - WALKER LANDFILL
PCPCMP
LAND USE MAP

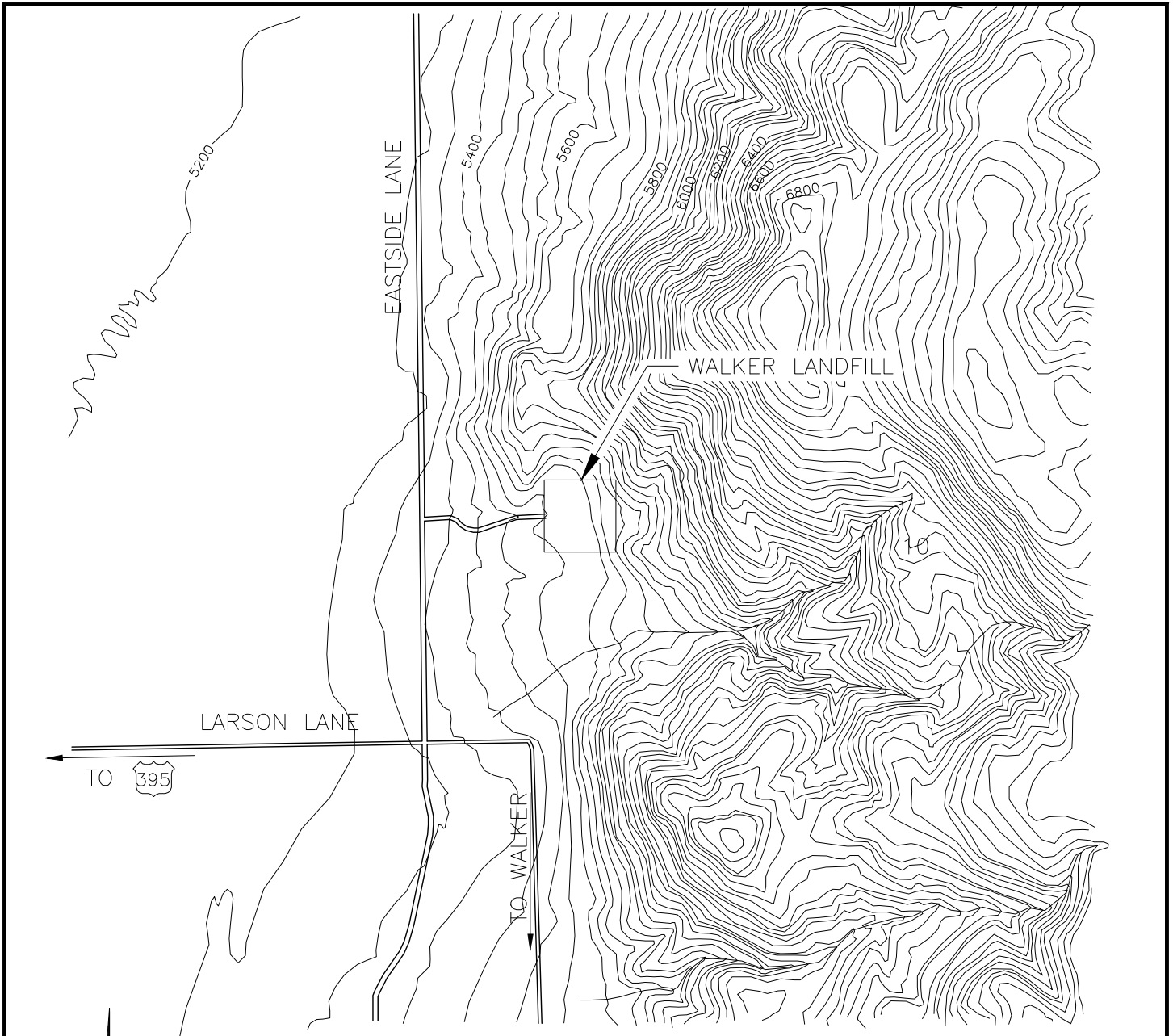

Base map digitized from the RISUE CANYON, NEV.-CALIF. 7.5 min. provisional edition 1988

NOTE:
 SOME DISPOSAL HAD OCCURRED AT THE
 WL PRIOR TO 1988 BUT NOT SIGNIFICANT
 TO CHANGE CONTOURS SHOWN

N.T.S.

NORTH

PREPARED BY:



800-C SOUTH ROCHESTER AVENUE
 ONTARIO, CALIFORNIA 91761

FIGURE 4

MONO COUNTY - WALKER LANDFILL
PCPCMP
PRE-LANDFILL TOPOGRAPHY

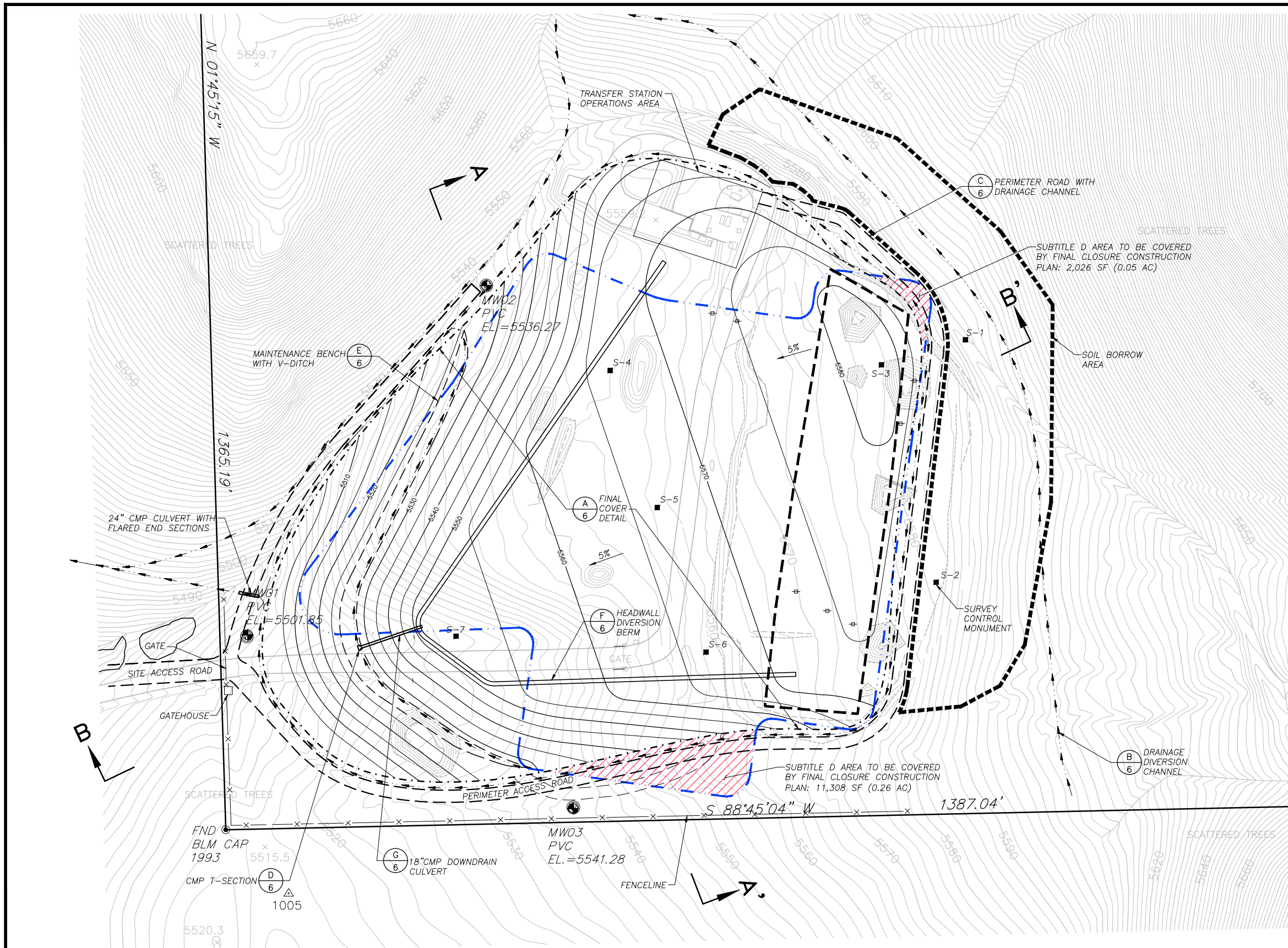

NOTE
 TOTAL SUBTITLE D AREA TO BE COVERED BY FINAL CLOSURE CONSTRUCTION PLAN: 0.31 ACRES (13,356 SF)

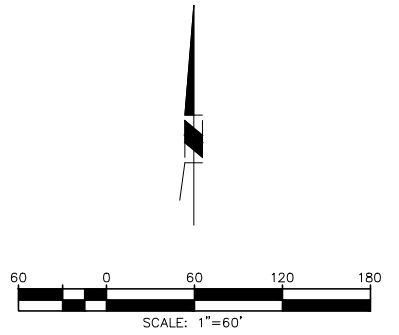

LEGEND

- S-3 ■ PROPOSED SETTLEMENT MONUMENT
- 5580 PROPOSED CONTOUR ELEVATION
- 5700 EXISTING CONTOUR ELEVATION
- B' CROSS SECTION
- PROPERTY BOUNDARY
- - - - - APPROXIMATE 10.4-ACRE SWFP WASTE FOOTPRINT*
- - - - - APPROXIMATE SUBTITLE D FOOTPRINT*
- x-x-x-x-x FENCELINE
- - - - - ROAD
- - - - - DRAINAGE
- - - - - SOIL BORROW AREA
- ▨ SUBTITLE D AREA TO BE COVERED BY FINAL CLOSURE CONSTRUCTION PLAN

NOTE
 TOTAL LANDFILL PROPERTY: APPROX. 43.5 ACRES

*THE COUNTY WILL NOT DISPOSE OF ANYTHING OTHER THAN INERT WASTES (AS DEFINED IN 27 CCR, SECTION 20230) OUTSIDE OF THE 7.6-ACRE APPROXIMATE SUBTITLE D FOOTPRINT WITHOUT PRIOR APPROVAL BY THE RWQCB. (SEE FIGURE 2 - SITE PLAN)

TOPO DATE: 2008 WITH UPDATED 2013 REFUSE FILL AREA

FIGURE 5

PREPARED BY: SWT Engineering Civil & Environmental 800 C SOUTH ROCHESTER AVENUE ONTARIO, CALIFORNIA 91761			PREPARED UNDER THE SUPERVISION OF 		
APPROVAL RECOMMENDED _____ DATE _____			DATE _____		
SOURCE: VECTOR ENGINEERING, PCPCMP 1998			MONO COUNTY - WALKER LANDFILL PCPCMP FINAL GRADING AND DRAINAGE PLAN		
DESIGNED BY :	SCALE : AS SHOWN	PROJECT NO: 828358	DRAWN BY :	DATE : 01-2014	
CHECKED BY :	DATE :		APPROVED BY :	DATE :	
SHEET 1 OF 2					

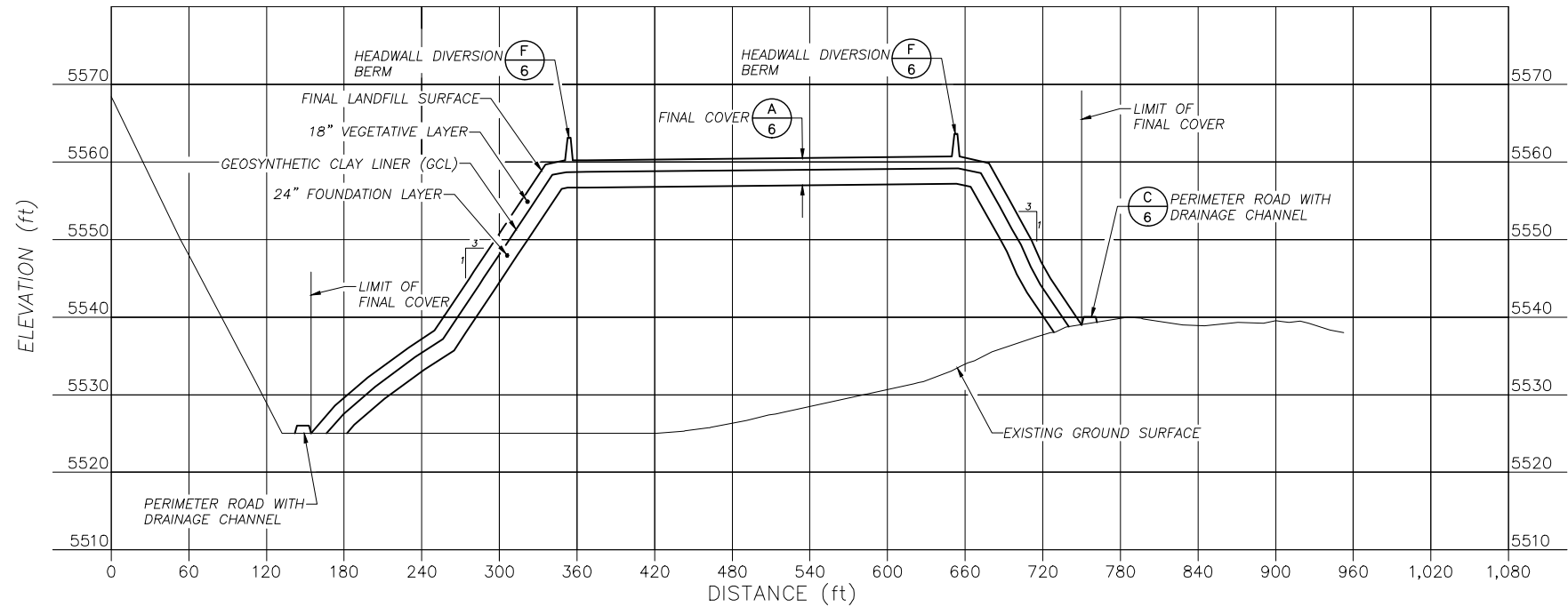

SECTION A-A'

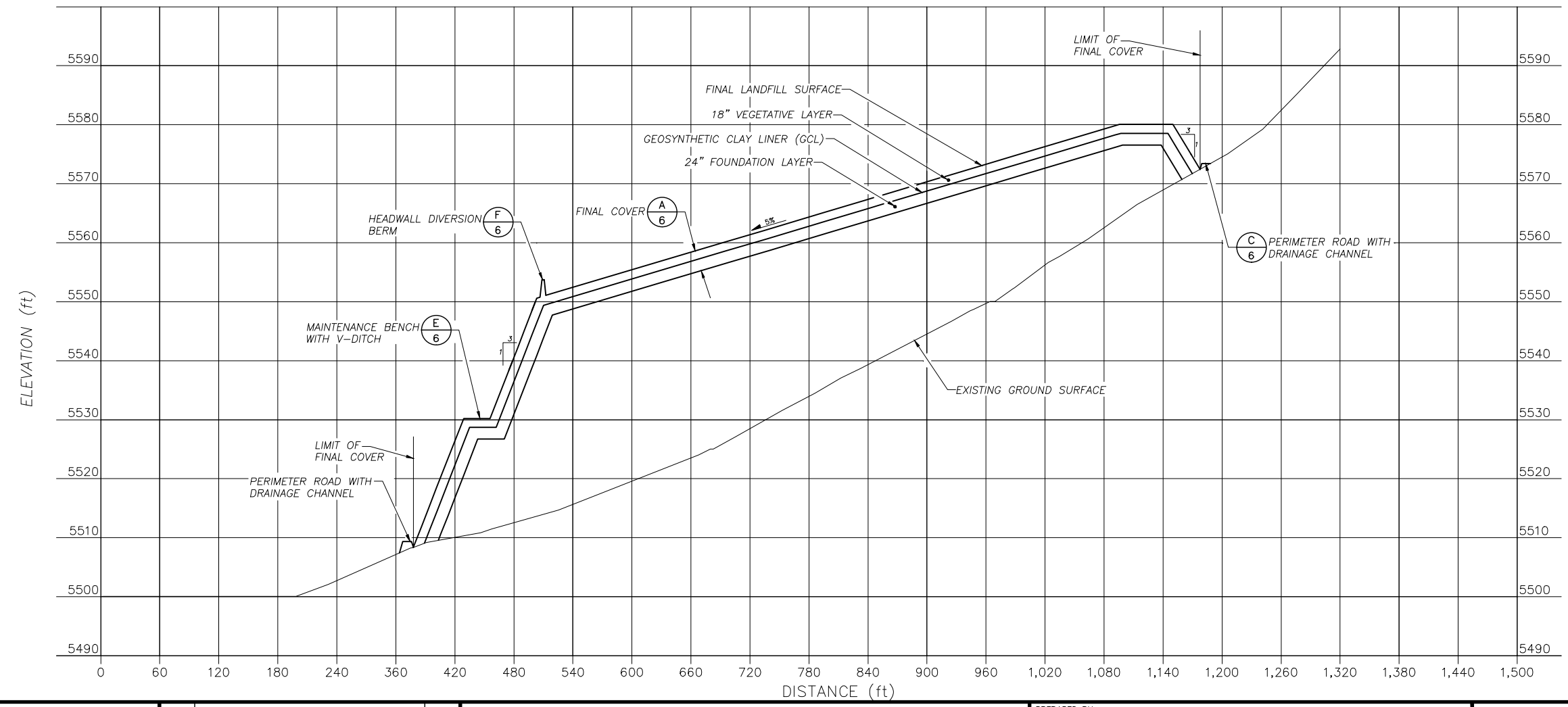

SECTION B-B'

SCALE:
HORIZONTAL 1"=60'
VERTICAL 1"=60'

FIGURE 5A

NO.	REVISION DESCRIPTION	DATE

APPROVAL RECOMMENDED _____ DATE _____

PREPARED BY:
SWT Engineering Civil & Environmental
800 C SOUTH ROCHESTER AVENUE
ONTARIO, CALIFORNIA 91761



MONO COUNTY - WALKER LANDFILL PCPCMP		
CROSS SECTIONS A-A' AND B-B'		
DESIGNED BY :	SCALE : AS SHOWN	PROJECT NO: 828358
DRAWN BY :	DATE : 10-2013	
CHECKED BY :	DATE :	
APPROVED BY :	DATE :	SHEET 2 OF 2

Z:\PROJECTS\MONO COUNTY\WALKER LANDFILL\PCPCMP\ACAD\FIGURES\FIG5A - CROSS SECTIONS

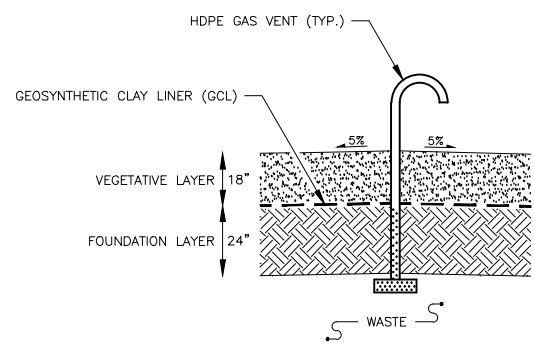

FINAL COVER WITH GAS VENT (A)
N.T.S. (3,4)

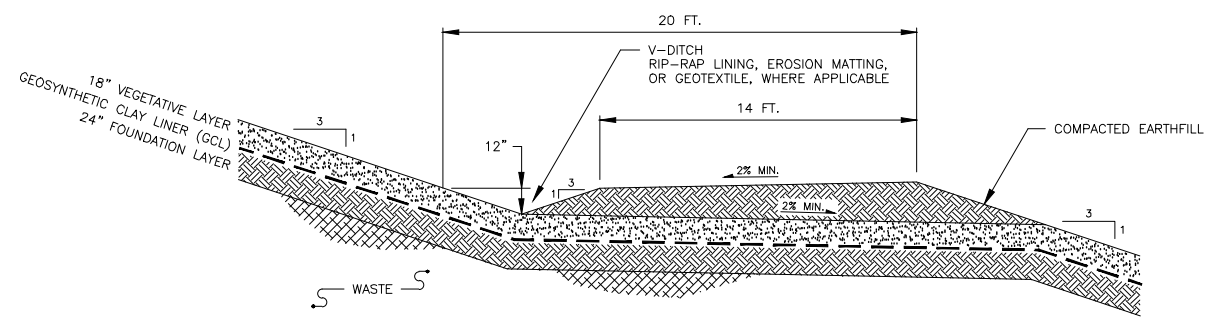

MAINTENANCE BENCH WITH V-DITCH (E)
N.T.S. (3)

NOTE:
(H/3) DELETED, SEE TYPICAL LANDFILL GAS PROBE DETAIL AS SEPARATE FIGURE

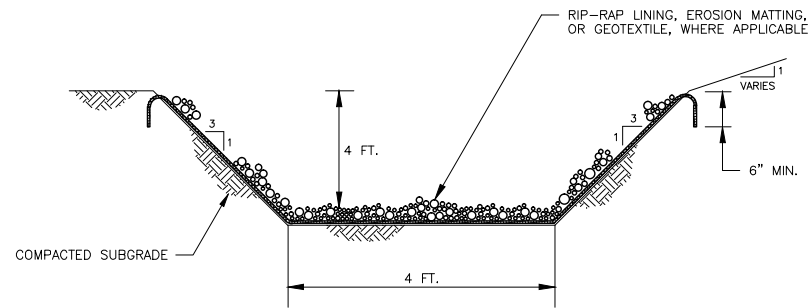

DRAINAGE DIVERSION CHANNEL (B)
N.T.S. (3)

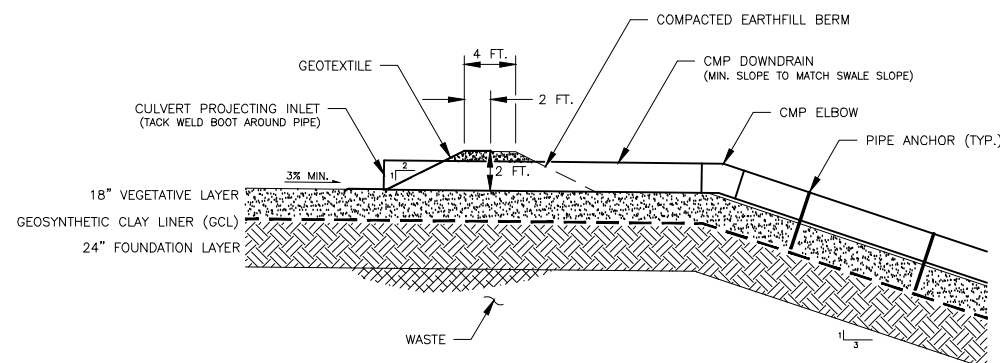

HEADWALL BERM (F)
N.T.S. (3,4)

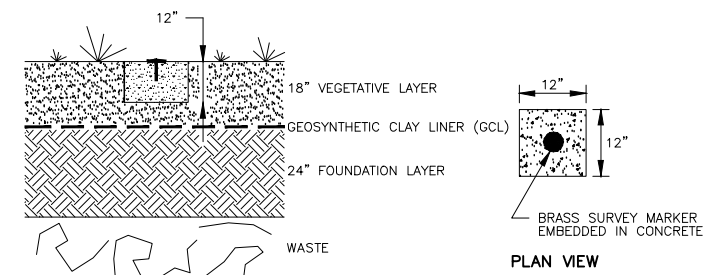

PROFILE
SETTLEMENT MONUMENT (I)
N.T.S. (3)

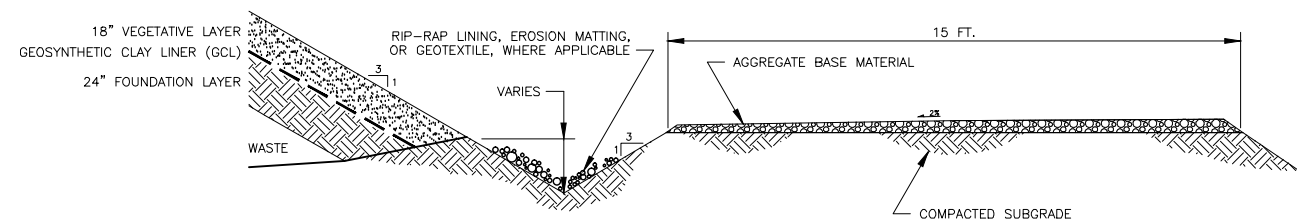

PERIMETER ROAD WITH DRAINAGE CHANNEL (C)
N.T.S. (3)

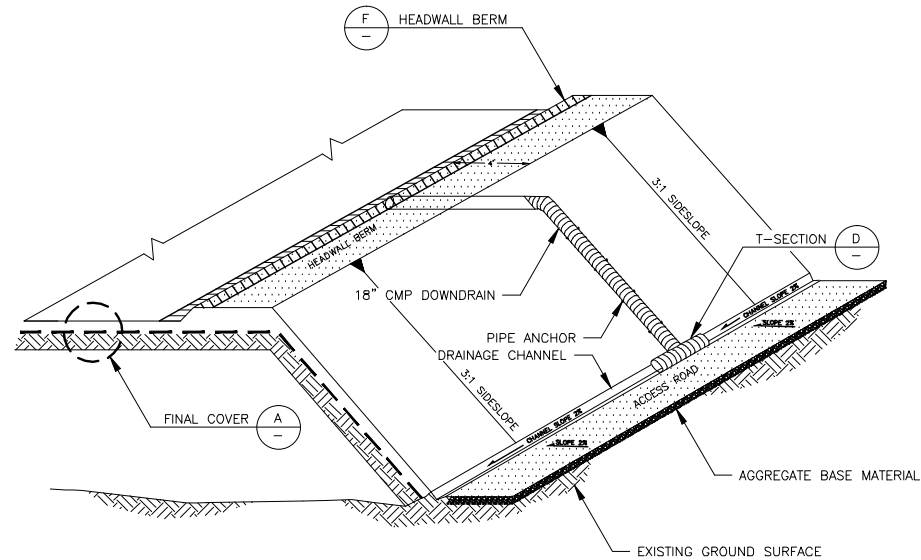

DOWNDRAIN CULVERT - ISOMETRIC VIEW (G)
N.T.S. (3)

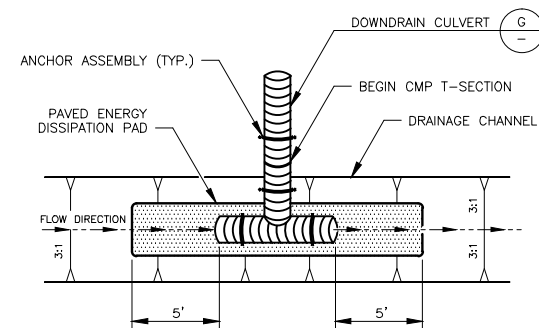

PLAN VIEW

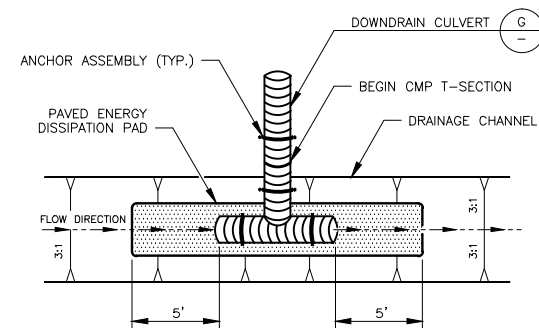

T-SECTION (D)
N.T.S. (3)

PREPARED BY:
SWT Civil & Environmental Engineering
800-C SOUTH ROCHESTER AVENUE
ONTARIO, CALIFORNIA 91761

SOURCE: VECTOR ENGINEERING, PCPCMP 1998

FIGURE 6

MONO COUNTY - WALKER LANDFILL
PCPCMP
DETAIL SHEET

Z:\PROJECTS\MONO COUNTY\WALKER LANDFILL\PCPCMP\ACAD\FIGURES\FIG06-DETAIL SHEET

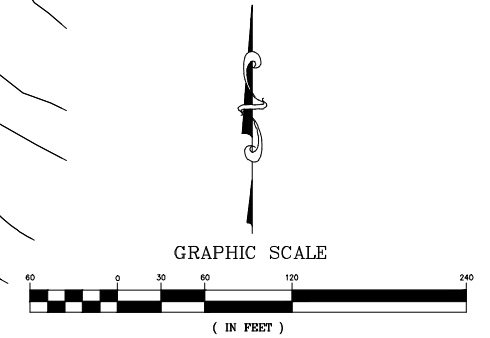
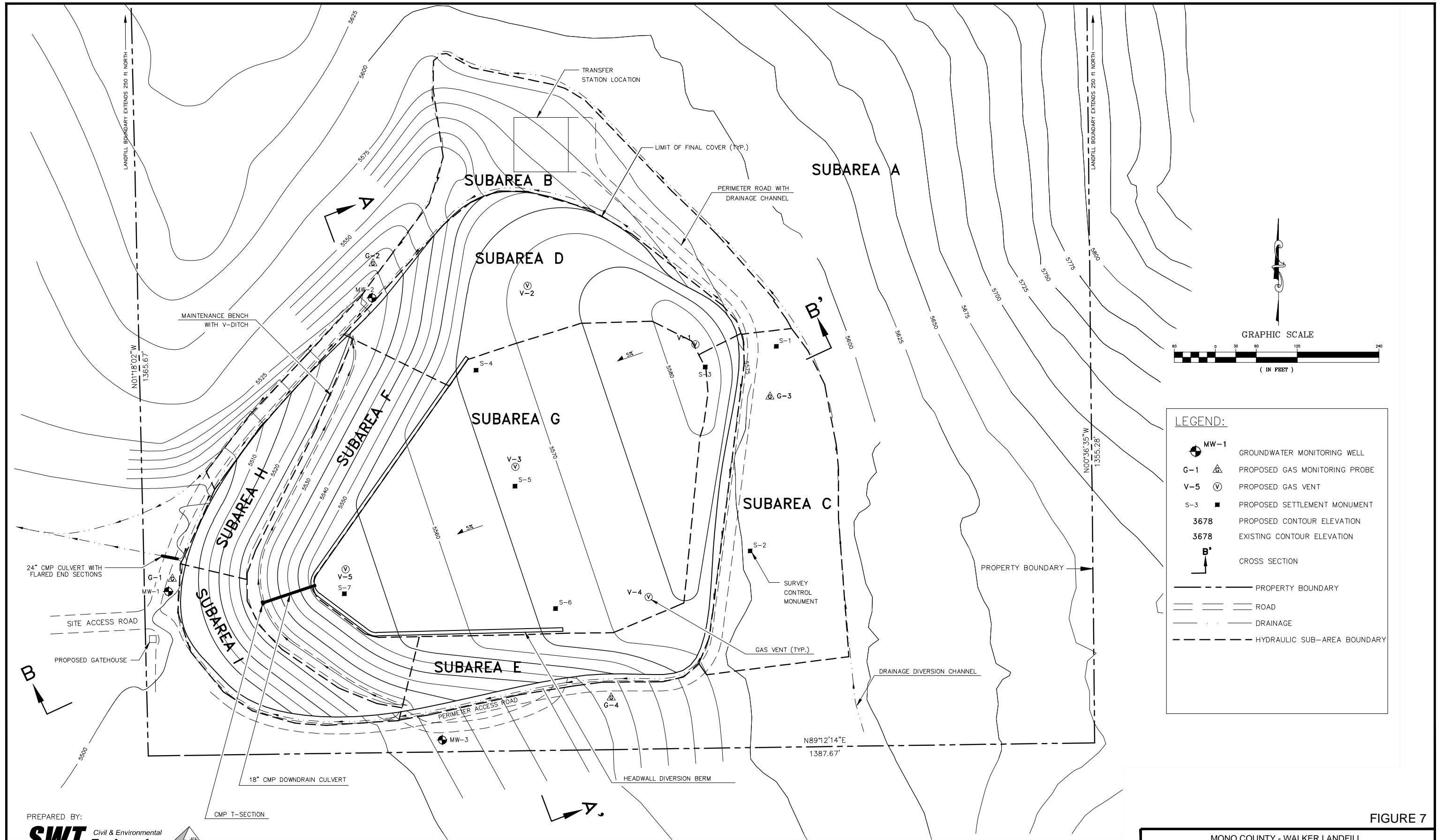

LEGEND:

	GROUNDWATER MONITORING WELL
	PROPOSED GAS MONITORING PROBE
	PROPOSED GAS VENT
	PROPOSED SETTLEMENT MONUMENT
	PROPOSED CONTOUR ELEVATION
	EXISTING CONTOUR ELEVATION
	CROSS SECTION
	PROPERTY BOUNDARY
	ROAD
	DRAINAGE
	HYDRAULIC SUB-AREA BOUNDARY

PREPARED BY:
SWT Engineering Civil & Environmental
 800-C SOUTH ROCHESTER AVENUE
 ONTARIO, CALIFORNIA 91761

SOURCE: VECTOR ENGINEERING, PCPCMP 1998

FIGURE 7
 MONO COUNTY - WALKER LANDFILL
 PCPCMP
 HYDRAULIC SUB-AREA

Z:\PROJECTS\MONO COUNTY\WALKER LANDFILL\PCPCMP\ACAD\FIGURES\FIG07-HYDRAULIC SUB-AREA

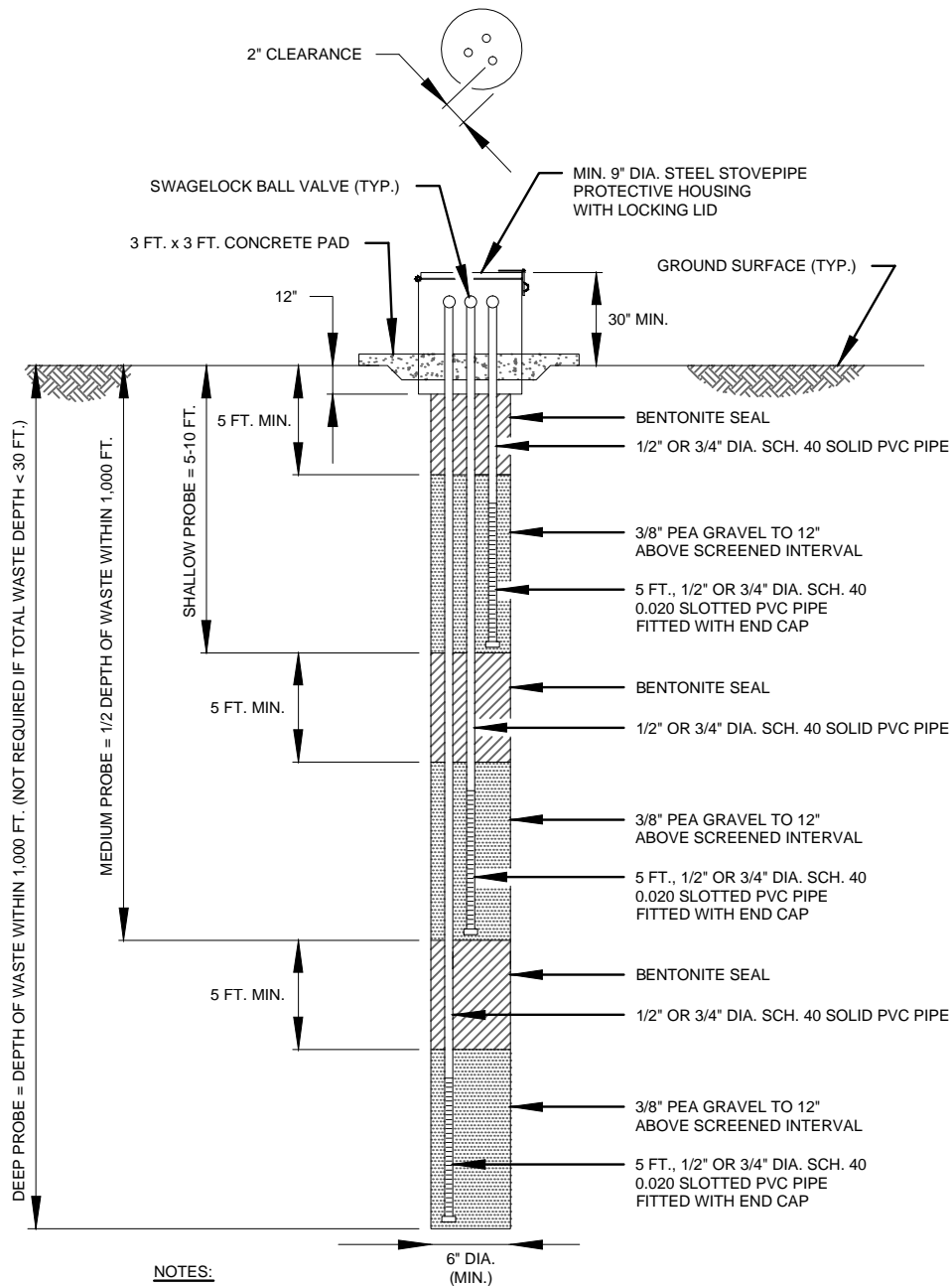

NOTES:

1. THE MAXIMUM DEPTH OF FORMER DISPOSAL TRENCHES IS APPROX. 20 FEET.
2. ALTHOUGH SITE SOILS CONSIST OF SANDS AND GRAVELS OVER THE FULL DEPTH OF WELL CONSTRUCTION, SCREENED SECTION WILL BE ADJUSTED TO ALIGN WITH STRATIGRAPHY THAT IS MOST CONDUCTIVE TO GAS FLOW.
3. EACH PROBE IS CLEARLY LABELED TO INDICATE UPPER, INTERMEDIATE OR LOWER PROBE AND SCREENED INTERVAL.
4. ALL JOINTS ARE FLUSH-THREADED. PVC GLUE WILL NOT BE USED.

PREPARED BY:



800-C SOUTH ROCHESTER AVENUE
ONTARIO, CALIFORNIA 91761

SOURCE: SRK CONSULTING,
SEPTEMBER 2009

FIGURE 8

MONO COUNTY - WALKER LANDFILL

PCPCMP

TYPICAL LANDFILL GAS PROBE DETAIL

APPENDIX A

Solid Waste Facility Permit

SOLID WASTE FACILITY PERMIT

Facility Number:
26-AA-0001

1. Name & Street Address of Facility: Walker Landfill 280 Offal Road Coleville, California 96107	2. Name & Mailing Address of Operator: Mono County Dept. of Public Works Post Office Box 457 Bridgeport, California 93517	3. Name & Mailing Address of Owner: Mono County Dept. of Public Works Post Office Box 457 Bridgeport, California 93517
--	---	--

4. Specifications:

a. Permitted Operations: Solid Waste Disposal Site Transformation Facility
 Transfer / Processing Facility (MRF) Other:
 Composting Facility

b. Permitted Hours of Operation: 7:00 am – 6:30 pm, Mondays, Thursdays, and Saturdays.
 Holidays: New Year's Day, July 4th, Thanksgiving, Christmas.

c. Permitted Maximum Tonnage: 500 tons per year (see LEA condition #17d).

d. Permitted Traffic Volume: 80 vehicles per day.

e. Key Design Parameters (Detailed parameters are shown on site plans bearing EA and CIWMB validations):

	Total	Disposal	Transfer / Processing	Composting	Transformation
Permitted Area (in acres)	43.5 ac.	10.4 ac.	1.6 ac.	n/a	n/a
Design Capacity (yd ³)		340,716 yd ³	n/a	n/a	n/a
Max. Elevation (Ft. MSL)		5580 ft.			
Max. Depth (Ft. BGS)		20 ft.			
Estimated Closure Year		2120			

Upon a significant change in design or operation from that described herein, this permit is subject to revocation or suspension. The attached permit findings and conditions are integral parts of this permit and supersede the conditions of any previously issued solid waste facility permit.

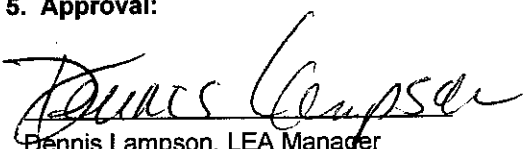
5. Approval:  Dennis Lampson, LEA Manager	6. Enforcement Agency Name and Address: Mono County Department of Health Services Post Office Box 476 Bridgeport, California 93517
---	--

7. Date Received by CIWMB: MAR 06 2007	8. CIWMB Concurrence Date: APR 19 2007
---	---

9. Permit Issued Date: 05/22/07	10. Permit Review Due Date: 05/22/12	11. Owner/Operator Transfer Date:
--	---	--

SOLID WASTE FACILITY PERMIT

Facility Number:

26-AA-0001

12. Legal Description of Facility:

Lot 3, Sec. 9, T.8 N., R.23 E., MDB&M

13. Findings:

- a. This permit is consistent with the Mono County Integrated Waste Management Plan, which was approved by the CIWMB on May 23, 2000. The location of the facility is identified in the Countywide Siting Element, pursuant to Public Resources Code (PRC), Section 50001(a).
- b. This permit is consistent with the standards adopted by the CIWMB, pursuant to PRC 44010.
- c. The design and operation of the facility is consistent with the State Minimum Standards for Solid Waste Handling and Disposal as determined by the enforcement agency, pursuant to PRC 44009.
- d. The Antelope Valley Fire Protection District has determined that the facility is in conformance with applicable fire standards, pursuant to PRC 44151.
- e. A Final Mitigated Negative Declaration was filed with the State Clearinghouse (SCH#2000012122) and certified by the Mono County Board of Supervisors on April 18, 2000. A Notice of Determination was filed with the State Clearinghouse and County Clerk on April 18, 2000. For the permit revision, an addendum to the Mitigated Negative Declaration was prepared and filed with the County Clerk on November 27, 2006.
- f. A transfer station operated within the landfill permitted boundaries has a Notification Tier permit (26-AA-0012), with its own allotted tonnage and traffic volume (vehicles per day).

14. Prohibitions:

The permittee is prohibited from accepting the following wastes:

Hazardous, radioactive, medical (as defined in Chapter 6.1, Division 20 of the Health and Safety Code), liquid, designated, or other wastes requiring special treatment or handling, except as identified in the Report of Disposal Site Information and approved amendments thereto and as approved by the enforcement agency and other federal, state, and local agencies.

15. The following documents describe and/or restrict the operation of this facility:

	Date		Date
Report of Disposal Site Information	Oct., 1995 Amended Nov., 2006	Preliminary Closure and Postclosure Maintenance Plan	Apr. 1998 Amended Nov., 2006
Waste Discharge Requirements Order No. 6-96-13	Feb. 8, 1996	Closure Financial Assurance Documentation	Oct. 5, 1993
APCD Permit to Operate	n/a	Operating Liability Certification	May 17, 2004
Mitigated Negative Declaration (SCH# 2000012122) & Amendment	April 18, 2000 & Nov. 27, 2006	Land Use and/or Conditional Use Permit (Resolution No. R00-031)	April 18, 2000

SOLID WASTE FACILITY PERMIT

Facility Number:

26-AA-0001

16. Self Monitoring:

The owner / operator shall submit the results of all self monitoring programs to the Enforcement Agency within 30 days of the end of the reporting period (for example, 1st quarter = January – March, the report is due by April 30, etc. Information required on an annual basis shall be submitted with the 4th quarter monitoring report, unless otherwise stated.)

Program	Reporting Frequency
a. The types and quantities (in tons) of waste, including separated or commingled recyclables, entering the facility per day.	Quarterly
b. The number and types of vehicles using the facility per day.	Quarterly
c. Results of the hazardous waste load-checking program, including the quantities and types of hazardous wastes, medical wastes, or otherwise prohibited wastes found in the waste stream and the disposition of these materials.	Annually
d. Copies of all written complaints regarding this facility and the operator's actions taken to resolve these complaints.	Quarterly
e. Results of the landfill gas monitoring program.	Quarterly
f. Wet weather preparedness report / winter operations plan.	Annually (due Nov. 1)
g. Fill sequencing plan for the forthcoming year.	Annually
h. Remaining site capacity.	Annually

SOLID WASTE FACILITY PERMIT

Facility Number:

26-AA-0001

17. Enforcement Agency (EA) Conditions:

- a. The operator shall comply with all State Minimum Standards for solid waste handling and disposal as specified in Title 27, California Code of Regulations (CCR).
- b. The operator shall maintain a log of special / unusual occurrences. This log shall include, but is not limited to, fires, explosions, the discharge and disposition of hazardous or unpermitted wastes, and significant injuries, accidents or property damage. Each log entry shall be accompanied by a summary of any actions taken by the operator to mitigate the occurrence. The log shall be available to site personnel and the EA at all times.
- c. Additional information concerning the design and operation of the facility shall be furnished upon request and within the time frame specified by the EA.
- d. The maximum permitted loading rate for this facility is 500 tons per year for all waste types (not to exceed 80 tons per day), and shall not receive more than this amount without a revision of this permit. Beyond the average amount of waste received, the waste types that can contribute to the maximum daily loading rate of 80 tons per day shall be limited to construction and demolition waste from occasional large construction projects and shall require EA notification at the time it is anticipated to occur.
- e. This permit is subject to review by the EA and may be suspended, revoked, or revised at any time for sufficient cause.
- f. The EA reserves the right to suspend or modify waste receiving and handling operations when deemed necessary due to an emergency, a potential health hazard, or the creation of a public nuisance.
- g. Any change that would cause the design or operation of the facility not to conform to the terms and conditions of this permit is prohibited. Such a change may be considered a significant change, requiring a permit revision. In no case shall the operator implement any change without first submitting a written notice of the proposed change, in the form of an RFI amendment, to the EA at least 180 days in advance of the change.
- h. A copy of this permit shall be maintained at the facility.

APPENDIX B

Site Life and Loading Rate Calculations

**WALKER LANDFILL
DIMINISHING LANDFILL CAPACITY PROJECTION (AS OF 12/01/2014)**

ASSUMPTIONS

AERIAL TOPOGRAPHY DATE: September 2008, with February 2013 Updated Areas		
INITIAL REMAINING AIRSPACE ⁽¹⁾ :	114,337 CY (as of 2/23/2013)	
DAYS/WK REFUSE ACCEPTED:	2.0 DAYS/WK	
LONG-TERM AIRSPACE UTILIZATION FACTOR (AUF) ⁽³⁾ :	0.400 TONS/CY	Projected Annual Growth Rates ⁽⁴⁾⁽⁵⁾ :
WASTE TO SOIL RATIO:	2.0 : 1	1.0% from (2011-2015)
WASTE INFLOW DATA: Mono County Solid Waste Program		1.2% from (2016+)
BUFFER:	0 YEARS	

CAPACITY PROJECTION SPREADSHEET

FISCAL YEAR ⁽²⁾	PHASE	CUMULATIVE CONSTRUCTED AIRSPACE (CY)	CONSUMED TONNAGE ⁽²⁾⁽⁴⁾	CONSUMED AIRSPACE (CY)	CUMULATIVE CONSUMED TONNAGE	CUMULATIVE CONSUMED AIRSPACE (CY)	DAILY COVER SOIL CONSUMPTION (CY)	AVAILABLE AIRSPACE AT END OF YEAR (CY)
Feb-13	REMAINING	340,716	90,551.60	226,379.0	226,379.0	226,379.0	-	114,337
2013 ^(1A)		340,716	75.9	189.8	226,454.9	226,568.8	63.3	114,147
2014 ^(1B)		340,716	366.2	915.5	226,821.1	227,484.3	305.2	113,232
2015		340,716	93.7	234.3	226,914.8	227,718.5	78.1	112,998
2016		340,716	94.8	237.1	227,009.6	227,955.6	79.0	112,760
2017		340,716	96.0	239.9	227,105.6	228,195.5	80.0	112,521
2018		340,716	97.1	242.8	227,202.7	228,438.3	80.9	112,278
2019		340,716	98.3	245.7	227,301.0	228,683.9	81.9	112,032
2020		340,716	99.5	248.6	227,400.4	228,932.6	82.9	111,783
2030 ⁽⁶⁾		340,716	1,006.5	2,516.3	228,407.0	231,448.9	838.8	109,267
2040		340,716	1,018.6	2,546.5	229,425.6	233,995.4	848.8	106,721
2050		340,716	1,030.8	2,577.1	230,456.4	236,572.4	859.0	104,144
2060		340,716	1,043.2	2,608.0	231,499.6	239,180.4	869.3	101,536
2070		340,716	1,055.7	2,639.3	232,555.3	241,819.7	879.8	98,896
2080		340,716	1,068.4	2,670.9	233,623.7	244,490.7	890.3	96,225
2090		340,716	1,081.2	2,703.0	234,704.9	247,193.6	901.0	93,522
2100		340,716	1,094.2	2,735.4	235,799.0	249,929.1	911.8	90,787
2110		340,716	1,107.3	2,768.3	236,906.3	252,697.3	922.8	88,019
2120		340,716	1,120.6	2,801.5	238,026.9	255,498.8	933.8	85,217
2130		340,716	1,134.0	2,835.1	239,161.0	258,333.9	945.0	82,382
2140		340,716	1,147.6	2,869.1	240,308.6	261,203.0	956.4	79,513
2150		340,716	1,161.4	2,903.5	241,470.0	264,106.6	967.8	76,609
2160		340,716	1,175.4	2,938.4	242,645.4	267,045.0	979.5	73,671
2170		340,716	1,189.5	2,973.6	243,834.8	270,018.6	991.2	70,697
2180		340,716	1,203.7	3,009.3	245,038.6	273,028.0	1,003.1	67,688
2190		340,716	1,218.2	3,045.4	246,256.8	276,073.4	1,015.1	64,643
2200		340,716	1,232.8	3,082.0	247,489.6	279,155.4	1,027.3	61,561
2210		340,716	1,247.6	3,119.0	248,737.1	282,274.4	1,039.7	58,442
2220		340,716	1,262.6	3,156.4	249,999.7	285,430.8	1,052.1	55,285
2230		340,716	1,277.7	3,194.3	251,277.4	288,625.0	1,064.8	52,091
2240		340,716	1,293.0	3,232.6	252,570.5	291,857.7	1,077.5	48,858
2250		340,716	1,308.6	3,271.4	253,879.0	295,129.1	1,090.5	45,587
2260		340,716	1,324.3	3,310.7	255,203.3	298,439.7	1,103.6	42,276
2270		340,716	1,340.2	3,350.4	256,543.4	301,790.1	1,116.8	38,926
2280		340,716	1,356.2	3,390.6	257,899.7	305,180.7	1,130.2	35,535
2290		340,716	1,372.5	3,431.3	259,272.2	308,612.0	1,143.8	32,104
2300		340,716	1,389.0	3,472.5	260,661.2	312,084.4	1,157.5	28,632
2310		340,716	1,405.6	3,514.1	262,066.8	315,598.6	1,171.4	25,117
2320		340,716	1,422.5	3,556.3	263,489.3	319,154.8	1,185.4	21,561
2330		340,716	1,439.6	3,599.0	264,928.9	322,753.8	1,199.7	17,962
2340		340,716	1,456.9	3,642.2	266,385.8	326,396.0	1,214.1	14,320

(Continued)
WALKER LANDFILL
DIMINISHING LANDFILL CAPACITY PROJECTION (AS OF 12/01/2014)

2350		340,716	1,474.3	3,685.9	267,860.1	330,081.8	1,228.6	10,634
2360		340,716	1,492.0	3,730.1	269,352.2	333,811.9	1,243.4	6,904
2370 ⁽⁶⁾		340,716	1,509.9	3,774.9	270,862.1	337,586.8	1,258.3	3,129
2371		340,716	152.8	382.0	271,014.9	337,968.8	127.3	2,747
2372		340,716	154.6	386.6	271,169.6	338,355.4	128.9	2,361
2373		340,716	156.5	391.2	271,326.1	338,746.6	130.4	1,969
2374		340,716	158.4	395.9	271,484.4	339,142.6	132.0	1,573
2375		340,716	160.3	400.7	271,644.7	339,543.3	133.6	1,173
2376		340,716	162.2	405.5	271,806.9	339,948.7	135.2	767
2377		340,716	164.1	410.4	271,971.0	340,359.1	136.8	357
2378		340,716	142.8	356.9	272,113.8	340,716.0	119.0	0
2379								
2380								

NOTES:

- (1) Aerial topo date is September 2008 with updated February 2013 areas having a remaining capacity of 114,337 cy.
 - A) Tonnage for March through December 2013 was 75.9 tons provided by Mono County Solid Waste Program Reports.
 - B) Tonnage for January through November 2014 was 361.5 tons with a projected December tonnage of 4.7 tons for a yearly volume of 366.2 tons.
- (2) The initial remaining capacity date was based on the Aerial Flyover Month and assumed to be at the end of the month.
- (3) The AUF was used from the previous site life capacity report done by Mono County Department of Public Works (AUF=0.400).
- (4) Tonnage growth rate based on Mono County Solid Waste Program calculated projections.
- (5) The growth rates were projected to be 1.0% increased from 2011-2015 and 1.2% from 2016 and on, as was done on the previous site life capacity report done by Mono County Department of Public Works
- (6) Starting from year 2030 to year 2370, these calculation lines account for 10 years for filling instead of just 1 year.

1:45'15" W

Volume 11--20--2013
 Base Surface 08 JUL with 13 FEB Without Stockpiles
 Comparison Surface Walker Final Grading
 Cut volume (unadjusted) 17,483.78 Cu. Yd
 Fill volume (unadjusted) 114,337.74 Cu. Yd
 Net volume (unadjusted) 96,853.97 Cu. Yd <FII>

1365.19'

1387.04'

S 88°45'10.4" W

EL=5541.28

FND
 BLM CAP
 1993
 5515.5

△ 1005



APPENDIX C

Landfill Gas Monitoring and Control Program



COUNTY OF MONO - DEPARTMENT OF PUBLIC WORKS

LANDFILL GAS MONITORING AND CONTROL PROGRAM

**WALKER LANDFILL
SWIS# 26-AA-0001
WDID# 6A260012000**

Mono County, California

Prepared by:



5250 Neil Road, Suite 300
Reno, Nevada 89502
(775) 828-6800
(775) 828-6820 (Fax)

and

County of Mono - Department of Public Works
Post Office Box 457
Bridgeport, California 93517
(760) 932-5440
(760) 932-5441 (Fax)

September 21, 2009

TABLE OF CONTENTS

	<u>Page</u>
1.0 BACKGROUND	5
2.0 LOCAL GEOLOGY AND HYDROGEOLOGY	6
3.0 SURROUNDING LAND USES	6
4.0 NATURE OF WASTE AND GAS GENERATION POTENTIAL	7
5.0 PROPOSED LANDFILL GAS MONITORING WELL NETWORK	8
6.0 MONITORING ACTIVITIES	10
6.1 STRUCTURE AND BOUNDARY MONITORING (27 CCR 20921).....	10
6.2 REPORTING	11
6.3 LANDFILL GAS DISCOVERY AND CONTROL.....	11
6.4 HEALTH AND SAFETY	12
7.0 REFERENCES	13

LIST OF TABLES

	<u>Page</u>
TABLE 5.1 Proposed Landfill Gas Monitoring Well Preliminary Construction Details	8

LIST OF APPENDICES

	<u>Page</u>
APPENDIX A - Figures	attached
Figure 1.1 – Site Location Map	
Figure 3.1 – Surrounding Zoning and Land Use Designations	
Figure 5.1 – Proposed Landfill Gas Well Locations	
Figure 5.2 – Typical Landfill Gas Monitoring Well Construction	

ENGINEER'S CERTIFICATION

This Landfill Gas Monitoring and Control Program for the Walker Landfill was prepared pursuant to Title 27 of the California Code of Regulations under the direct supervision of the undersigned civil engineer and in accordance with generally-accepted engineering principles and practices applicable at the time of its preparation. I certify that the information contained in this report is, to the best of my knowledge, true and correct.



R. Breese Burnley, R.C.E. No. C60507
Principal Engineer
SRK Consulting (U.S.), Inc.

1.0 BACKGROUND

The purpose of this report is to document compliance with Title 27, California Code of Regulations (27 CCR), Section 20921 – 20937, *et seq.*, at the Walker Landfill in Mono County, California. Figure 1.1 in Appendix A illustrates the location of the landfill within Mono County. The Mono County Department of Public Works (Public Works) currently monitors for the presence of methane in ambient air within structures and at the landfill boundaries at the Walker Landfill in accordance with 27 CCR Section 20931.

This *Landfill Gas Monitoring and Control Program* is comprised of the following sections:

- Section 1.0: site background and general information;
- Section 2.0: local geology and hydrogeology;
- Section 3.0: surrounding land uses;
- Section 4.0: the nature of the waste received at the site and its gas generation potential;
- Section 5.0: the physical configuration of the proposed landfill gas monitoring well network;
- Section 6.0: the current and proposed landfill gas monitoring plan for the landfill; and
- Section 7.0: previous and current subsurface gas migration and mitigation.

The Walker Landfill is located in the Antelope Valley region of Mono County at 280 Offal Road, Coleville, California, approximately 2.5 miles north of the community of Walker, California in Mono County. According to the Public Land Survey System, the landfill is situated within Section 9, Township 8 North, Range 23 East, Mount Diablo Baseline and Meridian (MDB&M). The landfill property encompasses 43 acres, 38 acres of which are currently permitted for use as a solid waste facility, and approximately 20 acres of which constitute the final filled waste footprint at closure and the largest area requiring closure at any given time during the life of the landfill. The total capacity of the Walker Landfill, including both in-place waste and remaining capacity, is estimated to be 340,716 cubic yards (Mono County, 2001).

The landfill property is owned by Mono County. The landfill is a Class III unlined landfill, constructed in 1970, and operates under existing Solid Waste Facility Permit number 26-AA-0001 issued by the Mono County Health Department. The on-site transfer station operates under separate Solid Waste Facility Permit number 26-AA-0012. The

Walker Landfill also operates pursuant to approved Waste Discharge Requirements per California Regional Water Quality Control Board Order 6-96-13.

Disposal operations occurred by trench-fill disposal method until 1998, when on-site burial of putrescible waste ceased and a temporary transfer station was installed to transfer residential and commercial municipal waste off-site for burial. A permanent transfer station was subsequently constructed and has been operational since 2002. Construction and demolition wastes continue to be buried on-site utilizing the area-fill method of disposal.

2.0 LOCAL GEOLOGY AND HYDROGEOLOGY

The Walker Landfill is located on the southeastern periphery of Antelope Valley and at the head of an alluvial talus slope at the base of the Sweetwater Mountains. Site soils are classified as Holbrook Stony Loam sand. These soils are composed of coarse granular deposits and consist of varying percentages of silt, sand, gravel, cobbles, and boulder with percolation rates ranging from low to moderate (BLM, 1997). The site is situated primarily on a talus slope composed of coarse-grained, well-indurated, intrusive rocks. Alluvial deposits of unknown thickness are found south and west of the site (CIWMB, 2003). Beneath the landfill are alluvial plain gravel and sand/mixtures (CRWQCB, 1996).

Ground water is part of the Antelope Valley Ground Water Basin (California Department of Water Resources Hydrologic Unit 6-107). Depth to ground water in the region surrounding the landfill is reported as approximately 300 feet below ground surface (CRWQCB, 1996). A drilling log for a well constructed ½-mile south of the landfill indicates the approximate depth to ground water is 315 feet (CIWMB, 2003). However, the static ground water elevation under the landfill is significantly higher, ranging from approximately 125 feet to 170 feet below native ground surface, as indicated by three ground water monitoring wells (MW-1, MW-2, and MW-3), which were installed just outside the south and west perimeter of the landfill footprint in May and June, 1988. These wells are sampled on a quarterly basis. According to data from the 2009 semi-annual evaluation monitoring report, static ground water occurs from approximately 5,368 to 5,391 feet amsl, with a gradient of approximately 0.036 feet per foot, and flow direction just to the west of south (Mono County, 2009).

3.0 SURROUNDING LAND USES

The properties surrounding the Walker Landfill have the following land use designations (Mono County, 2000):

- North of landfill: Resource Management (RM)/Public land managed by the U.S. Department of Interior, Bureau of Land Management (BLM).
- East of landfill: RM/BLM.
- South of landfill: RM/BLM.
- West of landfill: RM/BLM.

Surrounding land use is described as “open space” and “range land” (CIWMB, 2003) and as “farm land” (Mono County, 2003). Residential property exists to the southwest of the landfill, within 1,000 feet of the southwest corner of the landfill property. Surrounding land use and zoning designations are illustrated on Figure 3.1 in Appendix A.

4.0 NATURE OF WASTE AND GAS GENERATION POTENTIAL

The Walker Landfill, a Class III landfill, is permitted to accept the following waste types:

- Agricultural;
- Construction and demolition;
- Mixed municipal;
- Biosolids sludge; and
- Bulk metal (e.g., appliances, shredded auto)

The maximum permitted depth (thickness) of waste at the landfill is 20 feet and the maximum disposal elevation is 5,580 feet amsl (SWIS, 2007). Based on the existing site topography and past disposal operations (subgrade trench disposal to 20 feet bgs), the lowest elevation of waste has been estimated at approximately 5,505 feet amsl.

In accordance with 27 CCR Section 20220, the Walker Landfill is permitted to accept, and has historically accepted, all putrescible and non-putrescible solid and semi-solid waste including garbage, trash, refuse, paper, rubbish, ashes, industrial wastes, construction and demolition wastes, abandoned vehicles and parts thereof, discarded home and industrial appliances, manure, vegetable or animal solid and semi-solid wastes and other discarded wastes, provided that such wastes do not contain waste which must be managed as a hazardous waste, wastes which contain soluble pollutants in concentrations that exceed applicable water pollution control objectives, or wastes that could cause degradation of waters of the state (designated waste). However, under operational practices in effect since 1998, these types of wastes have not been buried on-site but have been processed through the Walker Transfer Station and shipped off-

site for disposal. Since that time, the only wastes buried at the Walker Landfill have been construction and demolition wastes.

Although the putrescible portion of the waste stream previously accepted and contained at the Walker Landfill does have the potential to generate methane, ambient air monitoring has not indicated the presence of methane at the ground surface.

5.0 PROPOSED LANDFILL GAS MONITORING WELL NETWORK

Proposed subsurface soil-gas monitoring will be accomplished by the installation and monitoring of four landfill gas monitoring wells (GW-1 through GW-4) located between the perimeter of the landfill waste footprint and the property boundary (Figure 5.1). Well and probe construction requirements as defined in 27 CCR 20925 are summarized in Table 5.1 and on the proposed typical well configuration detail in Figure 5.2. The final depth of each drill hole and the screened intervals for each probe will be adjusted during drilling based on encountered geology and the presence or absence of groundwater within the depth drilled.

Each well will be constructed with one, two, or three gas probes of ¾-inch diameter, schedule 40 PVC pipe with a minimum of one five-foot-long, 0.02-inch machine-slotted screened interval per probe. One gas probe will be installed in each well between approximately 5 and 10 feet below ground surface (bgs). For wells in areas where (within 1,000 feet of the well) the lowest waste elevation is more than 15 feet but less than 30 feet bgs, a second probe will be installed, with a screened interval at the lowest waste elevation at the landfill. Where the lowest waste elevation exceeds 30 feet bgs within 1,000 of the well, a third probe will be installed with a screened interval at the lowest waste elevation at the landfill.

TABLE 5.1. Landfill Gas Monitoring Well Completion Details

Well	GW-1	GW-2	GW-3	GW-4
Spacing (ft, left - refer to Figure 5.1)	300	953	953	636
Spacing (ft, right - refer to Figure 5.1)	636	300	652	652
Ground Elevation (estimated, elev, ft amsl)	5,559	5,534	5,582	5,539
Lowest Waste Elevation	5,515	5,515	5,515	5,515
Minimum Well Depth (ft bgs)	44	19	67	24
Well Base (elev, ft amsl)	5,505	5,505	5,505	5,505
Probe 1				
Screened (ft bgs) FROM	5	5	5	7
Screened (ft bgs) TO	10	10	10	12
Screened (elev, ft amsl) FROM	5,554	5,529	5,577	5,532
Screened (elev, ft amsl) TO	5,549	5,524	5,572	5,527
Probe 2				
Screened (ft bgs) FROM	17	17	30	19
Screened (ft bgs) TO	22	22	35	24
Screened (elev, ft amsl) FROM	5,542	5,517	5,552	5,520
Screened (elev, ft amsl) TO	5,537	5,512	5,547	5,515
Probe 3				
Screened (ft bgs) FROM	39		62	
Screened (ft bgs) TO	44		67	
Screened (elev, ft amsl) FROM	5,520		5,520	
Screened (elev, ft amsl) TO	5,515		5,515	
NOTE: Well location and elevation data estimated, pending final survey completion.				

6.0 MONITORING ACTIVITIES

6.1 Structure and Boundary Monitoring (27 CCR 20921)

Mono County currently performs landfill gas monitoring in ambient air within structures and at the property boundary in accordance with Title 27 of the California Code of Regulations (27 CCR), Section 20921. This section of 27 CCR requires all municipal solid waste landfill operators to ensure that the concentration of methane gas generated by their landfill does not exceed 1.25 percent by volume in air in on-site structures nor migrate off-site in concentrations exceeding 5 percent by volume in air (25 percent of the lower explosive limit, LEL) in on-site structures, or five percent by volume in air (100 percent of the LEL) migrating from the landfill at the property boundary. Accordingly, personnel from the Mono County Department of Public Works, Solid Waste Division, monitor methane concentrations at the landfill property boundary quarterly.

A Heath Gasurveyor Model 442 is currently used to monitor for the presence of methane in ambient air at the landfill perimeter and in site structures. The Gasurveyor samples air continuously and electronically records results in an internal memory that can be downloaded to a personal computer. The Gasurveyor Model 442 is capable of measuring methane concentrations from zero to 1,000 ppm and the lower explosive limit for methane from zero to 100 percent. For structure monitoring, the Heath Gasurveyor sampling tube is slowly moved throughout the interior of each structure at both floor and ceiling height.

Monitored locations include all areas where gas may potentially accumulate. Structures currently monitored at the Walker Landfill include the scalehouse, household hazardous waste storage lockers, and other recycling receptacles (refer to Figure 1). The base of each of these structures is elevated above the surrounding grade due to a skid-mounted frame, which allows the free circulation of air between the floor frame and ground surface. Should there be any additional structures constructed or installed at the site, they will be added to the inventory of monitoring locations.

During landfill perimeter monitoring, a technician holds the Gasurveyor sampling tube at waist height and walks the landfill perimeter. The results of structure and perimeter monitoring are reported as a percentage of the LEL for methane in quarterly reports to the Mono County Health Department. To date, methane has not been detected in ambient air at the Walker Landfill.

Ambient air monitoring in structures and at the property boundary will continue throughout site operations following well installation and during the postclosure period. In addition, a network of perimeter landfill gas monitoring wells to be installed prior to site closure will be monitored for methane concentrations using the Gasurveyor. The Gasurveyor's sampling pump inlet tube will be connected to a valve at the top of each gas probe and the sampling pump and monitor set to continuous monitoring mode. The variation of gas concentrations over time will be recorded until the concentrations of all gases (CO₂, O₂ and CH₄) do not fluctuate more than 0.5 percent.

As described in Section 5.0, Mono County will install a network of landfill gas monitoring wells by the regulatory deadline of September 21, 2010 [27 CCR 20921(b)(3)(B)(ii)]. The network will include four landfill gas wells with two to three probes per well, each designed to monitor a separate interval in the subsurface. The proposed well construction details and locations of monitoring wells are provided on the figures in Appendix A. Landfill gas monitoring will be performed during the postclosure maintenance period in accordance with 27 CCR Section 20921.

6.2 Reporting

Results of gas monitoring, including the initial and steady state concentrations of methane, are submitted to the local enforcement agency (LEA), the Mono County Environmental Health Department, within 90 days of sampling. Monitoring reports include:

- the concentration of methane measured at each monitoring location;
- date, time, barometric pressure, atmospheric temperature, and weather conditions;
- the name(s) of sampling personnel, equipment utilized, and a brief description of the methods used; and,
- a numbering system to correlate monitoring results to a corresponding probe location.

6.3 Landfill Gas Discovery and Control

If the concentration of methane exceeds the compliance levels described above, Mono County personnel will immediately take all steps necessary to protect public health and safety and the environment. Personnel will eliminate any threat of explosion, including barring access to the structure, posting warning signs, opening entry ways (and windows, if applicable) to introduce and circulate fresh air, and other courses of action

that may be appropriate. The LEA will be notified in writing within five working days of learning that compliance levels have been exceeded. LEA notification will include a description of the actions taken or proposed to be taken to resolve the problem. Within seven days of detection, the methane levels detected and a description of the steps taken to protect human health will be placed in the operating record.

Within 10 working days, Mono County will submit correspondence to the LEA describing the nature and extent of the problem, and any immediate corrective actions necessary to protect public health and safety and the environment. If the nature of the problem requires the development of a remediation plan and landfill gas control system, a plan and control system design will be prepared within 60 days of detection, in accordance with 27 CCR Section 20937(b-g). Approval will be obtained from the LEA prior to plan implementation. Following approval, Mono County will enter the plan in the facility's operating record, implement the plan, and notify the LEA when the plan has been implemented.

6.4 Health and Safety

Public Works maintains a site-specific Injury and Illness Prevention Program and Emergency Response Plan for the Walker Landfill. The details of these plans shall be adhered to when performing landfill gas monitoring activities.

All excavations shall be tested for the presence of methane prior to entry by personnel or equipment. All personnel and contractors shall be notified of the actual or potential presence of methane or other landfill gases in surface and subsurface utility boxes and trenches. All site-specific policies with regard to smoking shall be strictly adhered to. All landfill equipment shall be fitted with spark arrestors.

7.0 REFERENCES

Bureau of Land Management (BLM), 1997: *Landfill Transfer Audit – Walker, Bridgeport, Benton & Chalfant Recreation and Public Purposes (R&PP) Landfills*, unpublished report prepared for the U.S. Department of Interior, Bureau of Land Management by the BLM California State Office, Sacramento, California; March 20, 1997.

California Integrated Waste Management Board (CIWMB), 2003: Solid Waste Information System (SWIS) Database for Walker Landfill, Site Summary Details and Landfill Facility Compliance Study; www.ciwmb.ca.gov/SWIS and www.ciwmb.ca.gov/Landfills/ComplyStudy

California Regional Water Quality Control Board (CRWQCB), 1996: Board Order No. 6-96-13, WDID No. 6A260012000, *Revised Waste Discharge Requirements for Walker Class III Landfill*, February 1996.

Mono County, 2001: “RDSI Amendments – Walker Landfill (26-AA-0001)”; unpublished letter from Mono County Public Works to Mono County Public Health Department, October 22, 2001.

Mono County, 2009: *2009 Semi-Annual Report: Evaluation Monitoring Program for the Walker Landfill, Mono County, California*; July 2009, by Mono County Department of Public Works.

Mono County, 2003: *Initial Study & Environmental Checklist for Wood Processing and Alternative Cover Frequency at Mono County Disposal Sites*; Mono County, California, January 2003, by Mono County Department of Public Works.

Solid Waste Information System (SWIS), 2002: Walker Landfill Solid Waste Facility Permit A021; California Integrated Waste Management Board documents, online at <http://www.ciwmb.ca.gov/SWIS/26-AA-0001/Documents/Permit/392.pdf>

Solid Waste Information System (SWIS), 2007: Walker Landfill Solid Waste Facility Permit A021, revised 2007; California Integrated Waste Management Board documents, online at <http://www.ciwmb.ca.gov/SWIS/26-AA-0001/Documents/Permit/7549.pdf>

November 23, 2011
Project 146900.100

Mr. Matt Carter
Solid Waste Superintendent
Mono County Department of Public Works
74 North School Street
Bridgeport, California 93517

**Re: As-Built Report for Landfill Gas Monitoring Well Installations
Bridgeport, Pumice Valley, and Walker Landfills**

Dear Matt,

This report has been prepared by SRK Consulting (U.S.), Inc. (SRK) to provide as-built construction information and certification of as-built compliance with the approved design for the installation of landfill gas monitoring wells at the Bridgeport, Pumice Valley, and Walker landfills. This report summarizes well construction with the following:

1. A summary of the quality control procedures which were carried out during construction;
2. Figures presenting typical construction details and estimated as-built locations of each well (surveyed locations unavailable at the time of report preparation);
3. Summary tables providing screened interval depths for each probe;
4. Well construction logs for each well installation; and,
5. Photographs documenting construction methods and as-built surface completions.

The information provided in this report documents compliance with the requirements of Section 20925(d) of Title 27, California Code of Regulations (27 CCR 20925(d)). The following sections summarize the specifics of well design, bidding, and construction, and provide a description of variations to the proposed design and a summary of well completions.

1. Design Documentation

The proposed design and location of landfill gas monitoring wells were provided to the Local Enforcement Agency in September 2009 with the *Landfill Gas Monitoring and Control Plan* prepared for the Pumice Valley and Walker landfills. The plans detailed proposed well locations, construction methodology, probe quantities and depths at each location, and sampling port construction.

Based on the approved *Landfill Gas Monitoring and Control Plan*, seven new wells containing a total of 12 probes and a total well depth of 126 feet were required at the Pumice Valley Landfill. Four new wells containing a total of nine probes and a total well depth of 155 feet were required at the Walker Landfill. Monitoring well locations and design were developed in accordance with the requirements of 27 CCR 20925.

U.S. Offices:

Anchorage	907.677.3520
Denver	303.985.1333
Elko	775.753.4151
Fort Collins	970.407.8302
Reno	775.828.6800
Tucson	520.544.3688

Mexico Office:

Guadalupe,	
Zacatecas	52.492.927.8982

Canadian Offices:

Saskatoon	306.955.4778
Sudbury	705.682.3270
Toronto	416.601.1445
Vancouver	604.681.4196
Yellowknife	867.873.8670

Group Offices:

Africa
Asia
Australia
Europe
North America
South America

In addition, a new landfill gas monitoring well was proposed at the closed Bridgeport Landfill to replace an existing well located near the east access gate. It is believed that the existing well GW-3 was installed between two former waste disposal trenches; while not directly installed in waste, its close proximity has resulted in detections of landfill gas generation. Therefore, a replacement well was proposed to be installed in native soil along the eastern property boundary to determine whether landfill gas is migrating off-site. The replacement well was designed to replicate the number and depths of probes at the existing GW-3.

2. Project Development

SRK prepared a bid package with figures, special provisions, and technical specifications suitable for permitting, bidding, and construction. The resulting bid package included the *Project Plans and Specifications*, dated July 26, 2011, which was prepared under the direct supervision of a California-licensed civil engineer. The documents were issued for bidding and provided guidance for the drilling contractor and field personnel during construction. Further, SRK prepared permit applications for each monitoring location, including the completion of application forms for each site and summary tables specifying borehole and probe depths for each well. Once the drilling contractor was selected by Mono County, the permit application package was forwarded for signature; the completed applications with signatures by County and driller representatives should be on file with the Mono County Environmental Health Department.

3. Construction Quality Assurance

Mono County contracted with ABC Liovin Drilling, Inc., for construction of landfill gas monitoring wells at the Bridgeport, Pumice Valley, and Walker landfills. The contractor, based in Signal Hill, California, is a California-licensed C-57 well driller (license number 422904).

The contractor mobilized a truck-mounted hollow-stem auger rig and two support trucks to the Walker Landfill on October 3, 2011. A project kick-off meeting was conducted that morning with SRK and driller field personnel; well locations and access conditions were visually inspected and notable design criteria were reviewed at the meeting. Following well installations at the Walker Landfill, the contractor proceeded to the Bridgeport and Pumice Valley landfills, completing the project on October 7, 2011. Project locations are shown on **Figure 1-1** in **Attachment 1** to this report.

A civil engineer operating under the direct supervision of SRK's California-licensed civil engineer visually classified soils and logged each borehole in accordance with accepted practices and 27 CCR 20925(d). Well construction logs that graphically describe subsurface soil conditions, probe depths and screened intervals, location of bentonite seals, and construction materials were prepared from field logs; the completed logs are grouped by individual landfill in **Attachments 2-4**.

SRK's field personnel monitored the installation of each probe and construction of each well to ensure compliance with the approved design and 27 CCR 20925(d), including placement of a protective well casing and concrete slab. A profile detailing typical as-built construction materials is presented in **Figure 1-2** in **Attachment 1**. Photographs showing typical construction materials and methods are also presented in **Attachment 1**.

Position readings were made at each completed monitoring location by hand-held global positioning system (GPS) device. GPS locations of existing wells were also recorded at the same time so the new wells could be tied into the existing monitoring network. The approximate locations of each new well are shown relative to site boundaries and existing site conditions in **Figures 2-1, 3-1, and 4-1** for the Walker, Bridgeport, and Pumice Valley landfills, respectively. At the time of preparation of this report, the new well locations had not been verified on the ground by land survey.

4. Modifications to Original Design and/or Specifications

The monitoring wells and probes were constructed in general accordance with the approved design and locations. Based on conditions encountered in the field, however, some modifications were necessary, as summarized below.

Walker Landfill – Borehole advancement at GW-1 encountered bedrock at a depth of 57 feet below ground surface, where drilling was terminated and the well was completed. This was 14 feet short of the 71-foot design depth based on the estimated lowest waste elevation within 1,000 feet (horizontally). Similarly, three attempted boreholes for GW-4 met refusal at 24 feet below ground surface; the well was completed at this depth, which was 31 feet short of the projected design depth of 55 feet at this location. The total as-built well depth installed at this landfill was 112 feet rather than the projected total of 155 feet.

Landfill gas monitoring well GW-2 was moved approximately 120 feet north of its planned location to improve access and provide a monitoring point in better alignment between waste and the transfer station (i.e., closer to the transfer station). Due to access restricted by heavy tree cover and surface rocks, monitoring location GW-3 was moved approximately 50 feet north of its original position.

Bridgeport Landfill – Borehole advancement for replacement well GW-3R encountered ground water at 38 feet below ground surface. A bentonite seal was placed between 38 (base of the hole) and 35 feet below ground surface and the screen was installed at a depth of 30 to 35 feet. This was five feet shallower than the 40-foot design depth intended to replicate the existing GW-3. Given its location downhill from GW-3, however, a shallower depth was not unexpected.

Existing monitoring location GW-3 was not abandoned at this time, but will be done at the time replacement wells are contracted for the Benton Crossing, which is anticipated to take place during the 2012 construction season.

Pumice Valley Landfill – Monitoring well locations were consistent with the approved design, but borehole depths varied based on surface elevation GPS readings and the estimated waste depth within 1,000 feet (horizontally). The total as-built well depth installed at this landfill was 197 feet rather than the projected total of 126 feet.

5. As-Built Information

Detailed as-built information comprised of site maps, summary tables, well construction logs, and photographs are included in Attachments 1 through 4. The locations of project sites in the context of state and county boundaries are presented in **Figure 1-1** in **Attachment 1**, together with a typical well construction detail and photographs of typical construction materials and methods. The remaining attachments provide as-built information grouped by individual landfill, each consisting of a site map with well locations, a summary table of well coordinates, elevations, and probe depths, well construction logs, and site photographs. Arranged from north to south, **Attachment 2** provides as-built information for the Walker Landfill, **Attachment 3** provides the same for the Bridgeport Landfill, and **Attachment 4** addresses project details for the Pumice Valley Landfill.

Please contact me at 775.284.2218 or by email at enikirk@srk.com should you have any questions or comments regarding this as-built documentation.

Yours sincerely,

SRK Consulting (U.S.) Inc.



Evan Nikirk, PE
Principal Engineer

Cc: Jill Kearney, Mono County Environmental Health Department (LEA)
Zane Poulson, Inspection and Enforcement Agency, CalRecycle (MS10A-17)
Christine Karl, Permitting and Assistance Branch, CalRecycle (MS10A-15)
Michael Wochnick, Closure and Engineering Support Section, CalRecycle (MS 10A-18)
Don McGhie, Real Estate & Resource Section, Los Angeles Department of Water and Power

Attachments:

- Attachment 1 – General Construction Information
- Attachment 2 – Walker Landfill As-Built Information
- Attachment 3 – Bridgeport Landfill As-Built Information
- Attachment 4 – Pumice Valley Landfill As-Built Information

ATTACHMENT 1

GENERAL CONSTRUCTION INFORMATION

- PROJECT LOCATION MAP
- TYPICAL WELL DETAIL
- GENERAL CONSTRUCTION PHOTOGRAPHS

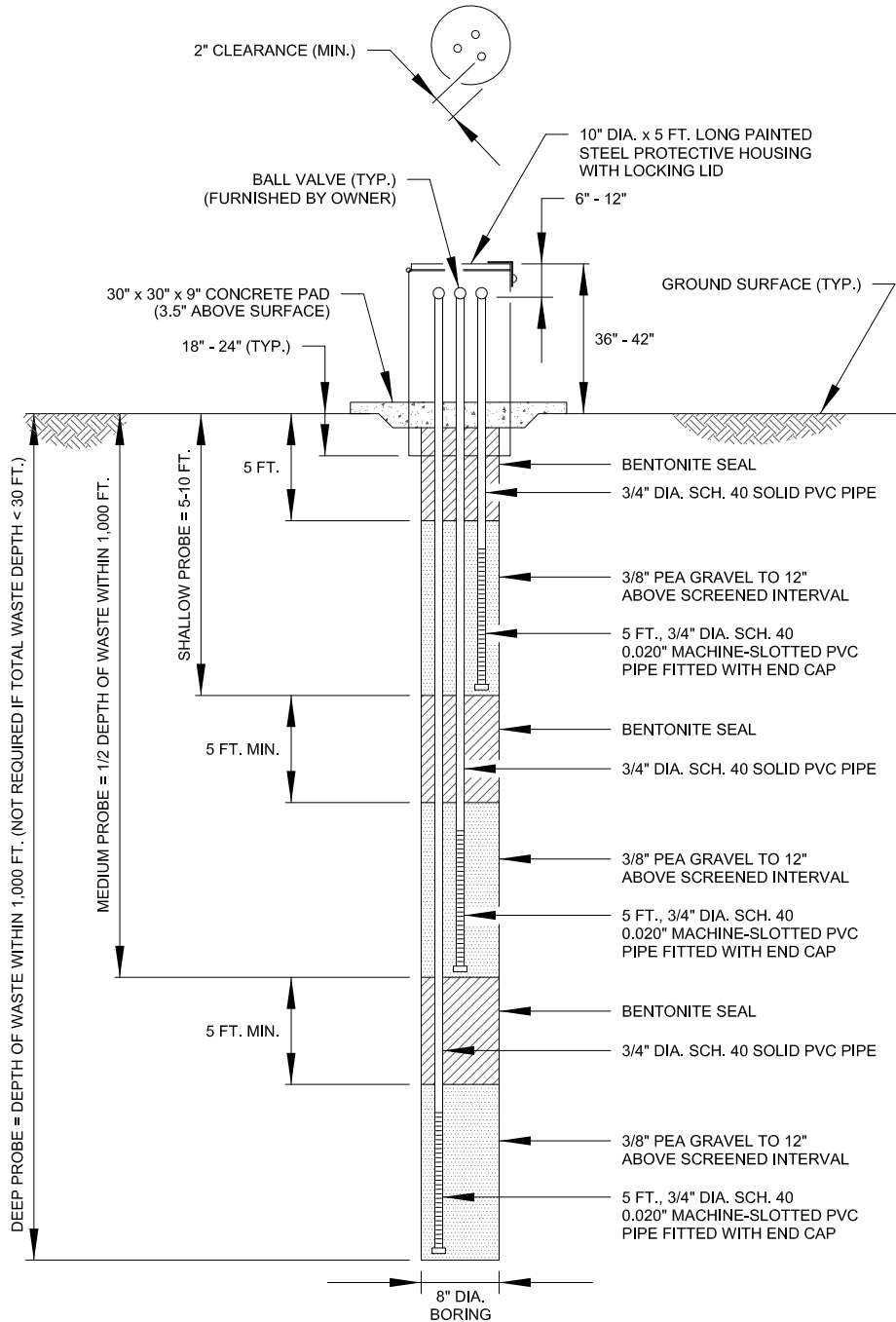

NOTES:

1. THE VALVE ON EACH PROBE IS LABELED TO INDICATE PROBE NUMBER CORRESPONDING TO SCREENED INTERVAL DEPTH (1 - SHALLOWEST, 3 - DEEPEST).
2. ALL JOINTS ARE FLUSH-THREADED. PVC GLUE OR ADHESIVES WERE NOT USED.



PREPARED FOR:
**COUNTY OF MONO
DEPARTMENT OF PUBLIC WORKS**

DRAWING TITLE:
**TYPICAL AS-BUILT LANDFILL GAS
MONITORING WELL CONSTRUCTION**

DESIGN:	EN	DRAWN:	SY	REVIEWED:	RBB
CHECKED:	---	APPROVED:	EN	DATE:	11.21.11
FILE NAME:	LFG_Wells_Fig1-2_TypWellDetail_As-Built_146900,100_20111121_en.dwg				

**LANDFILL GAS MONITORING WELL
INSTALLATION PROJECT
MONO COUNTY, CALIFORNIA**

DRAWING NO.	FIGURE 1-2	REVISION NO.	A
SRK JOB NO.	146900.100		

ATTACHMENT 1, AS-BUILT REPORT – TYPICAL CONSTRUCTION METHODS
LFG Well Installation Project – Mono County, California



Plate 1-1. Truck-mounted hollow-stem auger rig over borehole (PV LF GW-1, view west).



Plate 1-2. Support trucks and equipment for drill rig (PV LF GW-1, view west).

ATTACHMENT 1, AS-BUILT REPORT – TYPICAL CONSTRUCTION METHODS
LFG Well Installation Project – Mono County, California



Plate 1-3. Truck-mounted hollow-stem auger rig over borehole (WK LF GW-1, view south).



Plate 1-4. Typical five-foot long painted steel surface completion monument with locking cap.

ATTACHMENT 1, AS-BUILT REPORT – TYPICAL CONSTRUCTION METHODS

LFG Well Installation Project – Mono County, California



Plate 1-5. Close-up of typical locking cap on painted steel surface completion monument.

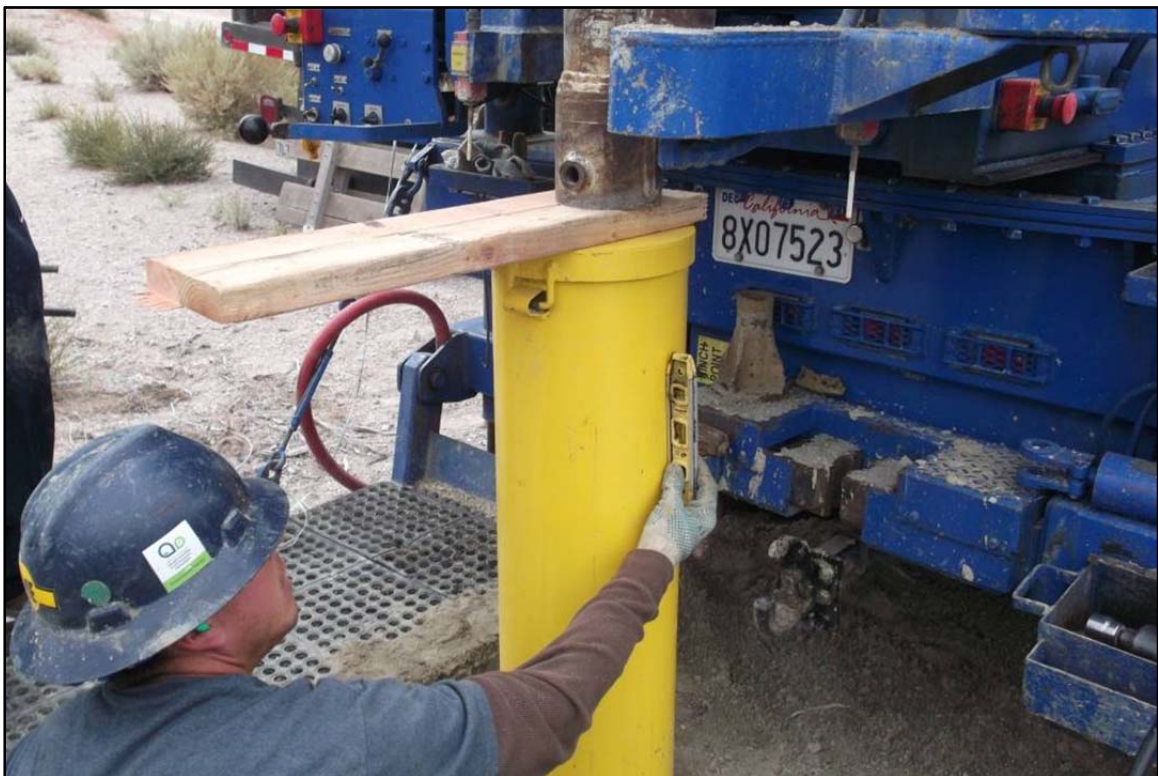

Plate 1-6. Balancing of surface completion monument with locking cap.

ATTACHMENT 1, AS-BUILT REPORT – TYPICAL CONSTRUCTION METHODS

LFG Well Installation Project – Mono County, California



Plate 1-7. Formwork and dug out base for surface completion concrete pad.

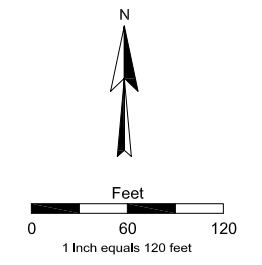
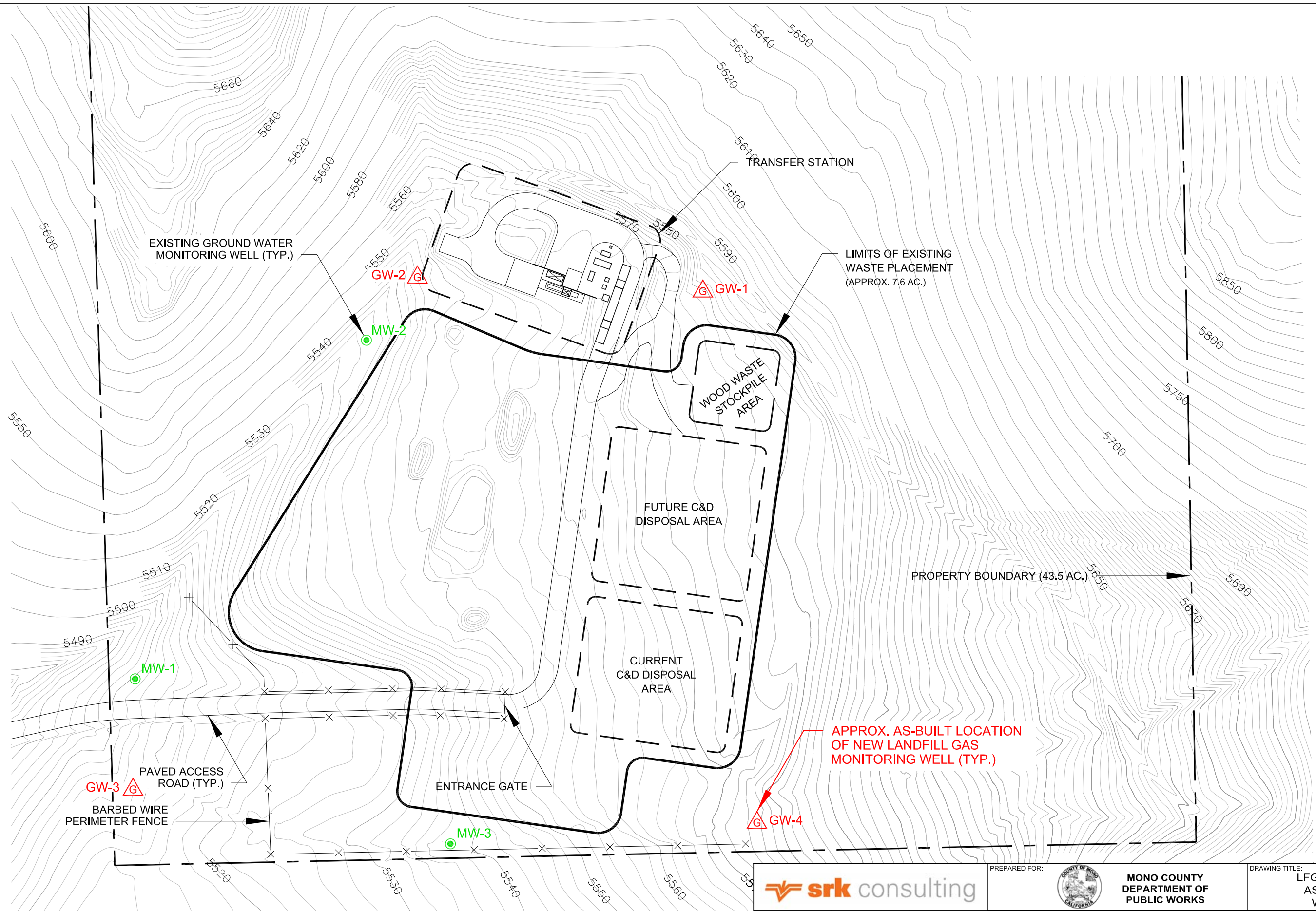

Plate 1-8. Typical ball valve landfill gas monitoring port inside protective casing (WK LF GW-3).

ATTACHMENT 2

WALKER LANDFILL AS-BUILT INFORMATION

- SITE MAP
- SUMMARY TABLE
- WELL CONSTRUCTION LOGS
- SITE PHOTOGRAPHS



BASE TOPOGRAPHIC MAP PREPARED BY SPENCER B. GROSS, INC. (RENO, NV) AND TRIAD / HOLMES ASSOCIATES (MAMMOTH LAKES, CA).
 DATE OF PHOTOGRAPHY: 04.21.08. CONTOUR INTERVAL: 2' MINOR, 10' MAJOR.



DESIGN: EN	DRAWN: BH	REVIEWED: RBB
CHECKED: ---	APPROVED: EN	DATE: 11.21.11
FILE NAME: LFG_Wells_Fig2-1_WKLF_As-Built_146900.100_20111121_bh.dwg		

PREPARED FOR:  **MONO COUNTY DEPARTMENT OF PUBLIC WORKS**

LANDFILL GAS MONITORING WELL INSTALLATION PROJECT
Mono County, California

DRAWING TITLE: **LFG MONITORING WELL AS-BUILT LOCATIONS WALKER LANDFILL**

DRAWING NO. **FIGURE 2-1**
 SRK JOB NO. **146900.100**

REVISION NO. **A**

As-Built Landfill Gas Monitoring Well Construction

Walker Landfill

WELL / PROBE	GW-1	GW-2	GW-3	GW-4
<u>Well Location</u>				
Northing (hddd.dddd deg) ¹	38.55531	38.55537	38.55358	38.55344
Easting (hddd.dddd deg) ¹	119.45419	119.45564	119.45676	119.45396
Ground Elevation (est., ft amsl) ^{1,2}	5,580	5,536	5,509	5,572
Lowest Waste Elevation (est., ft amsl) ³	5,515	5,515	5,515	5,515
Well Depth (ft bgs) ⁴	57	21	10	24
Well Depth (elev, ft amsl)	5,523	5,515	5,499	5,548
<u>Probe 1</u>				
Sealing Zone from (ft bgs)	0	0	0	0
Sealing Zone to (ft bgs)	4.5	4.5	4	4.5
Screened from (ft bgs)	5	5	5	5
Screened to (ft bgs)	10	10	10	10
Screened from (elev., ft amsl)	5,575	5,531	5,504	5,567
Screened to (elev., ft amsl)	5,570	5,526	5,499	5,562
<u>Probe 2</u>				
Sealing Zone from (ft bgs)	24	11	--	13
Sealing Zone to (ft bgs)	29	16	--	18
Screened from (ft bgs)	30	16	--	19
Screened to (ft bgs)	35	21	--	24
Screened from (elev., ft amsl)	5,550	5,520	--	5,553
Screened to (elev., ft amsl)	5,545	5,515	--	5,548
<u>Probe 3</u>				
Sealing Zone from (ft bgs)	46	--	--	--
Sealing Zone to (ft bgs)	51	--	--	--
Screened from (ft bgs)	52	--	--	--
Screened to (ft bgs)	57	--	--	--
Screened from (elev., ft amsl)	5,528	--	--	--
Screened to (elev., ft amsl)	5,523	--	--	--
NOTES:				
1. Well location and elevation data estimated from GPS readings in the field (NAD 1983 UTM Zone 15N).				
2. Estimated ground elevations are the GPS field measurement less 4 feet, since measurements were made at chest height.				
3. Estimated base elevation of former waste disposal trenches within 1,000 feet, based on former disposal practices.				
4. Bedrock encountered in GW-1 and GW-4 limited construction depth.				

PROJECT Landfill Gas Well Construction - Walker LF

PROJECT NO. 146900.100

TOTAL DEPTH: 57'

LOGGED BY Brian Bass

GROUND CONDITION

COORDINATES OF LOCATION

DATE 10.03.11

Native Ground

38.5553°N, 119.4542°E

EQUIPMENT 8" Hollow-stem Auger

GROUND ELEVATION

DRILLER ABC Liovin Drilling, Inc.

5,580 ft amsl (est. by GPS)

DEPTH (FEET)	GRAPHIC LOG	USCS SOIL CLASS	WELL COMPLETION	DESCRIPTION OF MATERIAL	
0		ML		Poorly-graded sandy SILT (ML) with some cobble and some boulders from 2' - 6'; brown; medium dense; dry; non-plastic	
5					Poorly-graded clayey SILT (ML); gray; very dense; dry; non-plastic
10					Poorly-graded sandy SILT (ML) with some gravel and trace cobble; grayish-brown; medium dense; dry; non-plastic
15					Poorly-graded clayey SILT (ML) with some gravel and some fine sand; brownish-gray; dense; moist; slight plasticity
20					
25					
30					
35					
40					
45					
50					
55					
60	Hard bedrock; no recovery; end of borehole.				

GROUND WATER ENCOUNTERED: n/a	SCREEN MATERIAL: 3/4" Sch. 40 PVC 0.020" machine slots SYMBOL: 5 - 10 ft bgs 30 - 35 ft bgs 52 - 57 ft bgs	WELL CONSTRUCTION MATERIAL: Blank PVC SYMBOL: 0 - 5 ft bgs 0 - 30 ft bgs 0 - 52 ft bgs	BACKFILL MATERIAL: Cuttings SYMBOL: 10 - 24 ft bgs 35 - 46 ft bgs
GROUND WATER STATIC: n/a	FILTER MATERIAL: 3/8" rock SYMBOL: 4.5 - 10 ft bgs 29 - 35 ft bgs 51 - 57 ft bgs	GROUT MATERIAL: n/a SYMBOL: n/a	WELL HEAD PROTECTION MATERIAL: 10" dia. steel monument HEIGHT: n/a
TOTAL DEPTH DRILLED: 57 ft bgs	SURFACE PLUG MATERIAL: n/a SYMBOL: n/a	SEAL MATERIAL: Bentonite chips SYMBOL: 0 - 4.5 ft bgs 24 - 29 ft bgs 46 - 51 ft bgs	WELL CASING DETAILS MATERIAL: PVC HEIGHT: 24" - 36" above ground

Feet (ft) below ground surface (bgs)

PROJECT Landfill Gas Well Construction - Walker LF

PROJECT NO. 146900.100

TOTAL DEPTH: 21'

LOGGED BY Brian Bass

GROUND CONDITION

COORDINATES OF LOCATION

DATE 10.03.11

Native Ground

38.5554°N, 119.4556°E

EQUIPMENT 8" Hollow-stem Auger

GROUND ELEVATION

DRILLER ABC Liovin Drilling, Inc.

5,536 ft amsl (est. by GPS)

DEPTH (FEET)	GRAPHIC LOG	USCS SOIL CLASS	WELL COMPLETION	DESCRIPTION OF MATERIAL
0		ML		Poorly-graded sandy SILT (ML) with some gravel and cobble; brown; loose; dry
5				
10				
15		GM/ML		Poorly-graded sandy SILT and Gravel (GM/ML) with some cobble; brown; loose; dry
20				
25				

GROUND WATER ENCOUNTERED: n/a	SCREEN MATERIAL: 3/4" Sch. 40 PVC 0.020" machine slots SYMBOL: 5 - 10 ft bgs 16 - 21 ft bgs	WELL CONSTRUCTION MATERIAL: Blank PVC SYMBOL: 0 - 5 ft bgs 0 - 16 ft bgs	BACKFILL MATERIAL: Cuttings SYMBOL: 10 - 11 ft bgs
GROUND WATER STATIC: n/a	FILTER MATERIAL: 3/8" rock SYMBOL: 4.5 - 10 ft bgs 16 - 21 ft bgs	GROUT MATERIAL: n/a SYMBOL:	WELL HEAD PROTECTION MATERIAL: 10" dia. steel monument HEIGHT: n/a
TOTAL DEPTH DRILLED: 21 ft bgs	SURFACE PLUG MATERIAL: n/a SYMBOL:	SEAL MATERIAL: Bentonite chips SYMBOL: 0 - 4.5 ft bgs 11 - 16 ft bgs	WELL CASING DETAILS MATERIAL: PVC HEIGHT: 24" - 36" above ground
Feet (ft) below ground surface (bgs)			

PROJECT Landfill Gas Well Construction - Walker LF

PROJECT NO. 146900.100

TOTAL DEPTH: 10'

LOGGED BY Brian Bass

GROUND CONDITION

COORDINATES OF LOCATION

DATE 10.04.11

Native Ground

38.5536°N, 119.4568°E

EQUIPMENT 8" Hollow-stem Auger

GROUND ELEVATION

DRILLER ABC Liovin Drilling, Inc.

5,509 ft amsl (est. by GPS)

DEPTH (FEET)	GRAPHIC LOG	USCS SOIL CLASS	WELL COMPLETION	DESCRIPTION OF MATERIAL
0		ML		Fine sandy SILT (ML) with trace pebbles and trace gravel; brown; loose; damp; non-plastic
5				Gravel and pebbles @ 7'
10				

GROUND WATER ENCOUNTERED: n/a	SCREEN MATERIAL: 3/4" Sch. 40 PVC 0.020" machine slots SYMBOL: 5 - 10 ft bgs	WELL CONSTRUCTION MATERIAL: Blank PVC SYMBOL: 0 - 5 ft bgs	BACKFILL MATERIAL: Cuttings SYMBOL: n/a
GROUND WATER STATIC: n/a	FILTER MATERIAL: 3/8" rock SYMBOL: 4 - 10 ft bgs	GROUT MATERIAL: n/a SYMBOL: n/a	WELL HEAD PROTECTION MATERIAL: 10" dia. steel monument HEIGHT: n/a
TOTAL DEPTH DRILLED: 10 ft bgs	SURFACE PLUG MATERIAL: n/a SYMBOL: n/a	SEAL MATERIAL: Bentonite chips SYMBOL: 0 - 4 ft bgs	WELL CASING DETAILS MATERIAL: PVC HEIGHT: 24" - 36" above ground

Feet (ft) below ground surface (bgs)

PROJECT Landfill Gas Well Construction - Walker LF

PROJECT NO. 146900.100

TOTAL DEPTH: 24'

LOGGED BY Brian Bass

GROUND CONDITION

COORDINATES OF LOCATION

DATE 10.05.11

Native Ground

38.5534°N, 119.4540°E

EQUIPMENT 8" Hollow-stem Auger

GROUND ELEVATION

DRILLER ABC Livioin Drilling, Inc.

5,572 ft amsl (est. by GPS)

DEPTH (FEET)	GRAPHIC LOG	USCS SOIL CLASS	WELL COMPLETION	DESCRIPTION OF MATERIAL
0		ML		Poorly-grade sandy SILT (ML) with some gravel and cobble; brown; loose; dry Hard drilling because of large cobble
5				
10				
15		GP		Cobble and Gravel (GP) with some silt; gray; hard/solid; dry Hard drilling
20		ML		Poorly-grade sandy SILT (ML) with some gravel and cobble; gray; medium dense; dry
21		BOULDER		Boulders; no recovery
25				Bedrock
30				Three separate attempted boreholes met refusal at same elevation.

GROUND WATER ENCOUNTERED: n/a	SCREEN MATERIAL: 3/4" Sch. 40 PVC 0.020" machine slots SYMBOL: 5 - 10 ft bgs 19 - 24 ft bgs	WELL CONSTRUCTION MATERIAL: Blank PVC SYMBOL: 0 - 5 ft bgs 0 - 19 ft bgs	BACKFILL MATERIAL: Cuttings SYMBOL: 10 - 13 ft bgs
GROUND WATER STATIC: n/a	FILTER MATERIAL: 3/8" rock SYMBOL: 4.5 - 10 ft bgs 18 - 24 ft bgs	GROUT MATERIAL: n/a SYMBOL:	WELL HEAD PROTECTION MATERIAL: 10" dia. steel monument HEIGHT: n/a
TOTAL DEPTH DRILLED: 24 ft bgs	SURFACE PLUG MATERIAL: n/a SYMBOL:	SEAL MATERIAL: Bentonite chips SYMBOL: 0 - 4.5 ft bgs 13 - 18 ft bgs	WELL CASING DETAILS MATERIAL: PVC HEIGHT: 24" - 36" above ground

Feet (ft) below ground surface (bgs)

ATTACHMENT 2, AS-BUILT REPORT – WALKER LANDFILL SITE PHOTOGRAPHS
LFG Well Installation Project – Mono County, California



Plate 2-1. Landfill gas monitoring well GW-1 (view north).



Plate 2-2. LFG monitoring well GW-1 (view north).

ATTACHMENT 2, AS-BUILT REPORT – WALKER LANDFILL SITE PHOTOGRAPHS

LFG Well Installation Project – Mono County, California



Plate 2-3. LFG monitoring well (background) from ground water monitoring well MW-2 (view north).



Plate 2-4. Landfill gas monitoring well GW-2 (view west).

ATTACHMENT 2, AS-BUILT REPORT – WALKER LANDFILL SITE PHOTOGRAPHS
LFG Well Installation Project – Mono County, California



Plate 2-5. LFG monitoring well GW-2 (view NW).



Plate 2-6. Landfill gas monitoring well GW-3 (view southwest).

ATTACHMENT 2, AS-BUILT REPORT – WALKER LANDFILL SITE PHOTOGRAPHS
LFG Well Installation Project – Mono County, California



Plate 2-7. LFG monitoring well GW-3 (view west).



Plate 2-8. Landfill gas monitoring well GW-4 (view southeast).

ATTACHMENT 2, AS-BUILT REPORT – WALKER LANDFILL SITE PHOTOGRAPHS
LFG Well Installation Project – Mono County, California



Plate 2-9. LFG monitoring well GW-4 (view south).

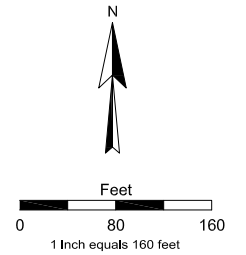
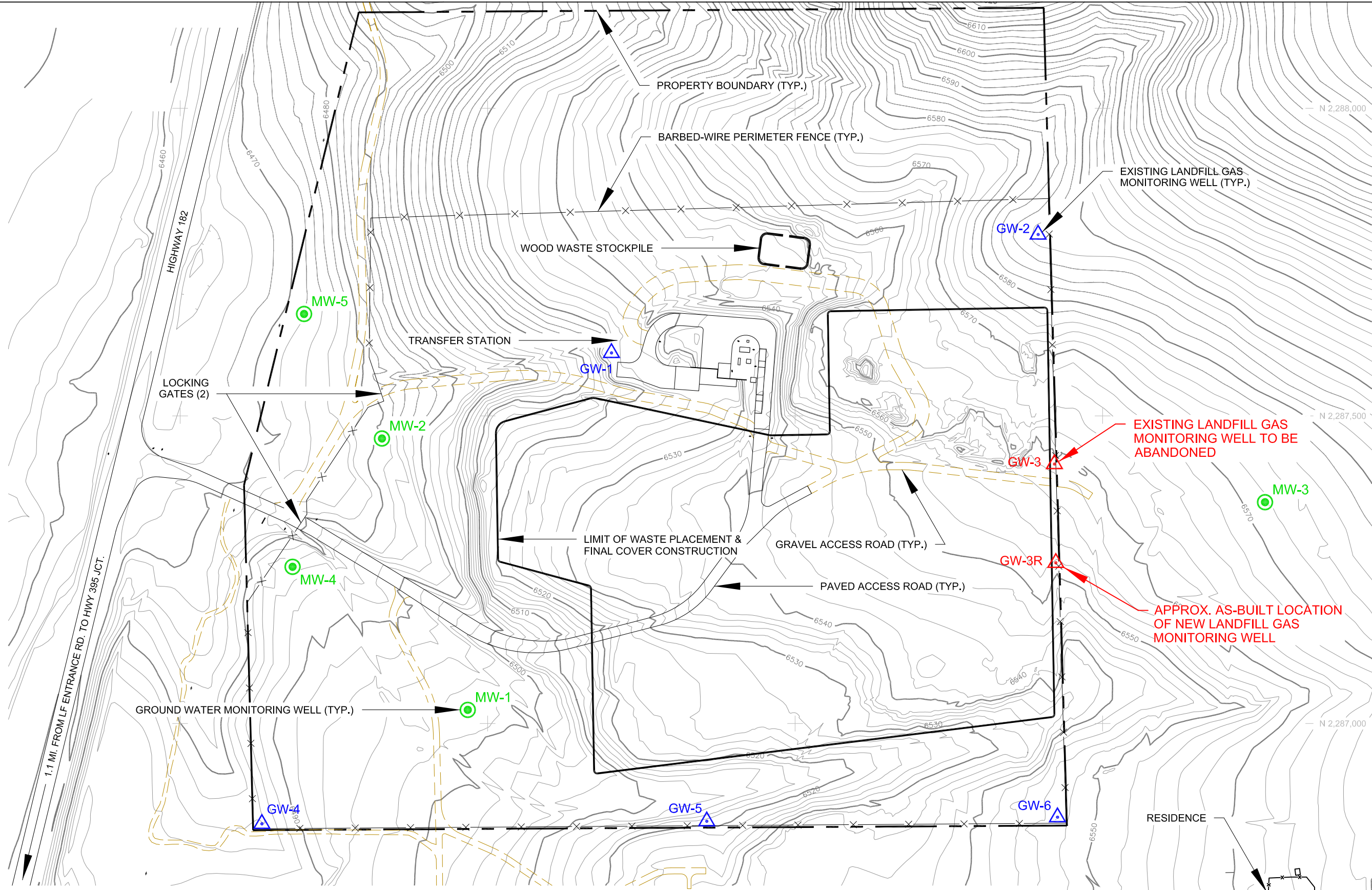

Plate 2-10. LFG monitoring well GW-4 with landfill and transfer station in background (view north).

ATTACHMENT 3

BRIDGEPORT LANDFILL AS-BUILT INFORMATION

- SITE MAP
- SUMMARY TABLE
- WELL CONSTRUCTION LOGS
- SITE PHOTOGRAPHS



BASE TOPOGRAPHIC MAP PREPARED BY SPENCER B. GROSS, INC. (RENO, NV) WITH TRIAD-HOLMES ASSOCIATES (MAMMOTH LAKES, CA). DATE OF PHOTOGRAPHY: 06/28/02 (EAST PORTION UPDATED 12/08/03). CONTOUR INTERVAL: 2' MINOR, 10' MAJOR.

			PREPARED FOR: 	DRAWING TITLE: LFG MONITORING WELL AS-BUILT LOCATIONS BRIDGEPORT LANDFILL
DESIGN: EN CHECKED: --- FILE NAME: LFG_Wells_Fig3-1_BPLF_As-Built_146900.100_2011121_bh.dwg	DRAWN: BH APPROVED: EN DATE: 11.21.11	REVIEWED: RBB DATE: 11.21.11	LANDFILL GAS MONITORING WELL INSTALLATION PROJECT Mono County, California	DRAWING NO. FIGURE 3-1 SRK JOB NO. 146900.100
				REVISION NO. A

As-Built Landfill Gas Monitoring Well Construction
Bridgeport Landfill

WELL / PROBE	GW-3R
<u>Well Construction</u>	
Northing (hddd.ddddd deg) ¹	38.26954
Easting (hddd.ddddd deg) ¹	119.21553
Ground Elevation (est., ft amsl) ^{1,2}	6,547
Lowest Waste Elevation (est., ft amsl) ³	6,500
Well Depth (ft bgs) ⁴	35
Well Depth (elev, ft amsl)	6,512
<u>Probe 1</u>	
Sealing Zone from (ft bgs)	0
Sealing Zone to (ft bgs)	4.5
Screened from (ft bgs)	5
Screened to (ft bgs)	10
Screened from (elev., ft amsl)	6,542
Screened to (elev., ft amsl)	6,537
<u>Probe 2</u>	
Sealing Zone from (ft bgs)	12
Sealing Zone to (ft bgs)	17
Screened from (ft bgs)	18
Screened to (ft bgs)	23
Screened from (elev., ft amsl)	6,529
Screened to (elev., ft amsl)	6,524
<u>Probe 3</u>	
Sealing Zone from (ft bgs)	25
Sealing Zone to (ft bgs)	29
Screened from (ft bgs)	30
Screened to (ft bgs)	35
Screened from (elev., ft amsl)	6,517
Screened to (elev., ft amsl)	6,512
NOTES:	
1. Well location and elevation data estimated from GPS readings in the field (NAD 1983 UTM Zone 15N).	
2. Estimated ground elevations are the GPS field measurement less 4 feet, because measurements were made at chest height.	
3. Estimated base elevation of former waste disposal trenches within 1,000 feet, based on former disposal practices.	
4. Ground water encountered, which limited construction depth.	

LOGGED BY Brian Bass

GROUND CONDITION

COORDINATES OF LOCATION

 DATE 10.05.11
Native Ground
38.2695°N, 119.2155°E

 EQUIPMENT 8" Hollow-stem Auger

GROUND ELEVATION

 DRILLER ABC Liovin Drilling, Inc.
6,547 ft amsl (est. by GPS)

DEPTH (FEET)	GRAPHIC LOG	USCS SOIL CLASS	WELL COMPLETION	DESCRIPTION OF MATERIAL
0		SP		Poorly-graded silty fine SAND (SP) with trace pebbles and trace gravel; brown; loose; moist; non-plastic
5				Some gravel and pebbles; dry @ 5'
10				Brownish-gray @ 8'
15	ML	ML		Clayey SILT (ML) with fine sand and little gravel; grayish-brown; moist; medium dense; slight plasticity
20				Some gravel and pebbles @ 18'
25	SP	SP		Poorly-graded silty fine SAND (SP) with trace pebbles and trace gravel; brown; loose; moist; non-plastic
30				Brownish-gray @ 30'
35				No pebbles and no gravel; some medium sand; gray; wet @ 35'
40				Wet / saturated @ 38'; static ground water measured @ 38'

GROUND WATER ENCOUNTERED: 38 ft bgs	SCREEN MATERIAL: 3/4" Sch. 40 PVC 0.020" machine slots SYMBOL: 5 - 10 ft bgs 18 - 23 ft bgs 30 - 35 ft bgs	WELL CONSTRUCTION MATERIAL: Blank PVC SYMBOL: 0 - 5 ft bgs 0 - 18 ft bgs 0 - 30 ft bgs	BACKFILL MATERIAL: Cuttings SYMBOL: n/a
GROUND WATER STATIC: 38 ft bgs	FILTER MATERIAL: 3/8" rock SYMBOL: 4.5 - 12 ft bgs 17 - 25 ft bgs 29 - 35.5 ft bgs	GROUT MATERIAL: n/a SYMBOL:	WELL HEAD PROTECTION MATERIAL: 10" dia. steel monument HEIGHT: n/a
TOTAL DEPTH DRILLED: 40 ft bgs	SURFACE PLUG MATERIAL: n/a SYMBOL:	SEAL MATERIAL: Bentonite chips SYMBOL: 0 - 4.5 ft bgs 25 - 29 ft bgs 12 - 17 ft bgs 35.5 - 40 ft bgs	WELL CASING DETAILS MATERIAL: PVC HEIGHT: 24" - 36" above ground

Feet (ft) below ground surface (bgs)

ATTACHMENT 3, AS-BUILT REPORT – BRIDGEPORT LANDFILL SITE PHOTOGRAPHS
LFG Well Installation Project – Mono County, California



Plate 3-1. Landfill gas monitoring well GW-3R with LFG vent in final cover to right (view south).

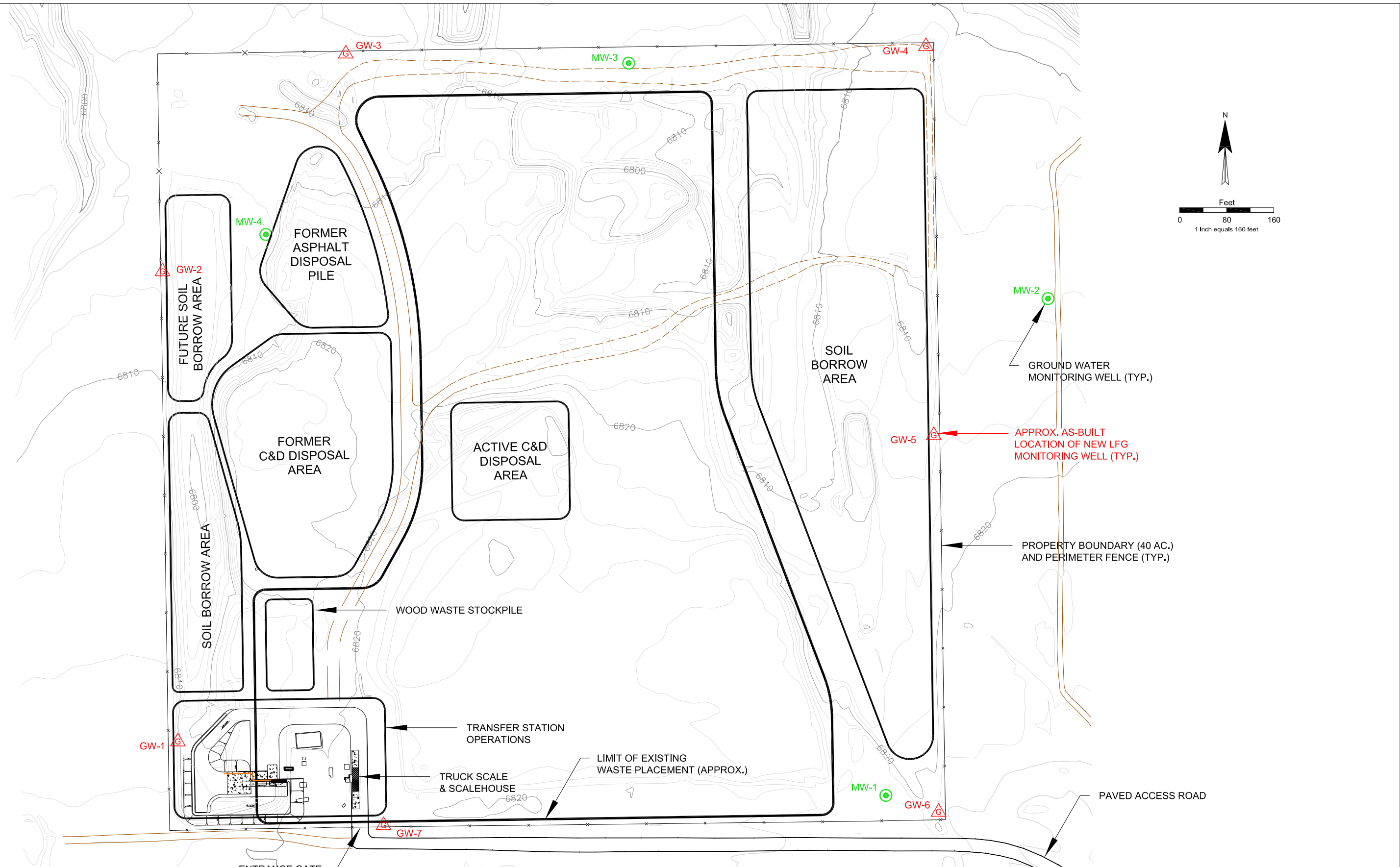

Plate 3-2. Landfill gas monitoring well GW-3R with GW-3 in background just to right (view north).

ATTACHMENT 4

PUMICE VALLEY LANDFILL AS-BUILT INFORMATION

- SITE MAP
- SUMMARY TABLE
- WELL CONSTRUCTION LOGS
- SITE PHOTOGRAPHS



BASE TOPOGRAPHIC MAP PREPARED BY SPENCER B. GROSS, INC. (RENO, NV) AND TRIAD / HOLMES ASSOCIATES (MAMMOTH LAKES, CA).
 DATE OF PHOTOGRAPHY: 04.21.08. CONTOUR INTERVAL: 2' MINOR, 10' MAJOR.



DESIGN: EN	DRAWN: BH	REVIEWED: RBB
CHECKED: ---	APPROVED: EN	DATE: 11.21.11
FILE NAME: LFG_Wells_Fig4-1_PVLF_As-Built_146900.100_20111121_bh.dwg		

PREPARED FOR:



**MONO COUNTY
DEPARTMENT OF
PUBLIC WORKS**

**LANDFILL GAS MONITORING WELL
INSTALLATION PROJECT
Mono County, California**

DRAWING TITLE:
**LFG MONITORING WELL
AS-BUILT LOCATIONS
PUMICE VALLEY LANDFILL**

DRAWING NO. FIGURE 4-1	REVISION NO.
SRK JOB NO. 146900.100	A

As-Built Landfill Gas Monitoring Well Construction

Pumice Valley Landfill

WELL / PROBE	GW-1	GW-2	GW-3	GW-4	GW-5	GW-6	GW-7
Well Construction							
Northing (hddd.ddddd deg) ¹	37.90629	37.90848	37.90951	37.90949	37.90766	37.9059	37.90588
Easting (hddd.ddddd deg) ¹	119.06879	119.06885	119.06774	119.06432	119.06432	119.06432	119.06759
Ground Elevation (est., ft amsl) ^{1,2}	6,803	6,817	6,824	6,825	6,822	6,825	6,820
Lowest Waste Elevation (est., ft amsl) ³	6,790	6,790	6,790	6,790	6,790	6,790	6,790
Well Depth (ft bgs)	13	27	34	35	32	26	30
Well Depth (elev, ft amsl)	6,790	6,790	6,790	6,790	6,790	6,799	6,790
Probe 1							
Sealing Zone from (ft bgs)	0	0	0	0	0	0	0
Sealing Zone to (ft bgs)	7	4.5	4.5	4.5	4.5	4.5	4.5
Screened from (ft bgs)	8	5	5	5	5	5	5
Screened to (ft bgs)	13	10	10	10	10	10	10
Screened from (elev., ft amsl)	6,795	6,812	6,819	6,820	6,817	6,820	6,815
Screened to (elev., ft amsl)	6,790	6,807	6,814	6,815	6,812	6,815	6,810
Probe 2							
Sealing Zone from (ft bgs)	--	16	23	24	21	15	19
Sealing Zone to (ft bgs)	--	21	28	29	26	20	24
Screened from (ft bgs)	--	22	29	30	27	21	25
Screened to (ft bgs)	--	27	34	35	32	26	30
Screened from (elev., ft amsl)	--	6,795	6,795	6,795	6,795	6,804	6,795
Screened to (elev., ft amsl)	--	6,790	6,790	6,790	6,790	6,799	6,790
NOTES:							
1. Well location and elevation data estimated from GPS readings in the field (NAD 1983 UTM Zone 15N).							
2. Estimated ground elevations are the GPS field measurement less 4 feet, because measurements were made at chest height.							
3. Estimated base elevation of former waste disposal trenches within 1,000 feet, based on former disposal practices.							

LOGGED BY Brian Bass

GROUND CONDITION

COORDINATES OF LOCATION

DATE 10.07.11

Native Ground

37.9063°N, 119.0688°E

EQUIPMENT 8" Hollow-stem Auger

GROUND ELEVATION

DRILLER ABC Liovin Drilling, Inc.

6,803 ft amsl (est. by GPS)

DEPTH (FEET)	GRAPHIC LOG	USCS SOIL CLASS	WELL COMPLETION	DESCRIPTION OF MATERIAL
0		ML		Fine sandy SILT (ML) with trace pebbles; brown; loose; damp; non-plastic
5				Grayish-brown @ 6'
10				Light gray; no pebbles @ 11'
15				
20				

GROUND WATER ENCOUNTERED: n/a	SCREEN MATERIAL: 3/4" Sch. 40 PVC SYMBOL: 8 - 13 ft bgs	WELL CONSTRUCTION MATERIAL: Blank PVC SYMBOL: 0 - 8 ft bgs	BACKFILL MATERIAL: Cuttings SYMBOL: n/a
GROUND WATER STATIC: n/a	FILTER MATERIAL: 3/8" rock SYMBOL: 7 - 13 ft bgs	GROUT MATERIAL: n/a SYMBOL:	WELL HEAD PROTECTION MATERIAL: 10" dia. steel monument HEIGHT: n/a
TOTAL DEPTH DRILLED: 13 ft bgs	SURFACE PLUG MATERIAL: n/a SYMBOL:	SEAL MATERIAL: Bentonite chips SYMBOL: 0 - 7 ft bgs	WELL CASING DETAILS MATERIAL: PVC HEIGHT: 24" - 36" above ground

Feet (ft) below ground surface (bgs)

LOGGED BY Brian Bass

GROUND CONDITION
Native Ground

COORDINATES OF LOCATION
37.9085°N, 119.0689°E

DATE 10.06.11

EQUIPMENT 8" Hollow-stem Auger

GROUND ELEVATION
6,817 ft amsl (est. by GPS)

DRILLER ABC Liovin Drilling, Inc.

DEPTH (FEET)	GRAPHIC LOG	USCS SOIL CLASS	WELL COMPLETION	DESCRIPTION OF MATERIAL
0		ML		Fine SILT (ML); light pinkish-gray; loose; dry; non-plastic
5				Light gray with little pebbles @ 13'
10				
15				
20		SM		Silty SAND (SM) with pebbles and some gravel; gray; loose; moist; non-plastic
25				
30				

GROUND WATER ENCOUNTERED: n/a	SCREEN MATERIAL: 3/4" Sch. 40 PVC 0.020" machine slots SYMBOL: 5 - 10 ft bgs 22 - 27 ft bgs	WELL CONSTRUCTION MATERIAL: Blank PVC SYMBOL: 0 - 5 ft bgs 0 - 22 ft bgs	BACKFILL MATERIAL: Cuttings SYMBOL: 10 - 16 ft bgs
GROUND WATER STATIC: n/a	FILTER MATERIAL: 3/8" rock SYMBOL: 4.5 - 10 ft bgs 21 - 27 ft bgs	GROUT MATERIAL: n/a SYMBOL: n/a	WELL HEAD PROTECTION MATERIAL: 10" dia. steel monument HEIGHT: n/a
TOTAL DEPTH DRILLED: 27 ft bgs	SURFACE PLUG MATERIAL: n/a SYMBOL: n/a	SEAL MATERIAL: Bentonite chips SYMBOL: 0 - 4.5 ft bgs 16 - 21 ft bgs	WELL CASING DETAILS MATERIAL: PVC HEIGHT: 24" - 36" above ground
Feet (ft) below ground surface (bgs)			

LOGGED BY Brian Bass

GROUND CONDITION

COORDINATES OF LOCATION

DATE 10.06.11

Native Ground

37.9095°N, 119.0677°E

EQUIPMENT 8" Hollow-stem Auger

GROUND ELEVATION

DRILLER ABC Liovin Drilling, Inc.

6,824 ft amsl (est. by GPS)

DEPTH (FEET)	GRAPHIC LOG	USCS SOIL CLASS	WELL COMPLETION	DESCRIPTION OF MATERIAL
0		ML		Poorly-graded fine sandy SILT (ML) with trace pebbles; light gray; loose; dry; non-plastic
5				Grayish-brown @ 7'
10				No pebbles and no gravel @ 10'
15		SM		Poorly-graded silty fine SAND (SM) with some coarse sand; little pebbles and trace gravel; gray; loose; damp; non-plastic
20				
25		ML		Poorly-graded fine sandy SILT (ML) with some coarse sand and trace pebbles; gray; loose; dry; non-plastic
30				
35				

GROUND WATER ENCOUNTERED: n/a	SCREEN MATERIAL: 3/4" Sch. 40 PVC SYMBOL: 5 - 10 ft bgs 29 - 34 ft bgs	WELL CONSTRUCTION MATERIAL: Blank PVC SYMBOL: 0 - 5 ft bgs 0 - 29 ft bgs	BACKFILL MATERIAL: Cuttings SYMBOL: 10 - 23 ft bgs
GROUND WATER STATIC: n/a	FILTER MATERIAL: 3/8" rock SYMBOL: 4.5 - 10 ft bgs 28 - 34 ft bgs	GROUT MATERIAL: n/a SYMBOL:	WELL HEAD PROTECTION MATERIAL: 10" dia. steel monument HEIGHT: n/a
TOTAL DEPTH DRILLED: 34 ft bgs	SURFACE PLUG MATERIAL: n/a SYMBOL:	SEAL MATERIAL: Bentonite chips SYMBOL: 0 - 4.5 ft bgs 23 - 28 ft bgs	WELL CASING DETAILS MATERIAL: PVC HEIGHT: 24" - 36" above ground

Feet (ft) below ground surface (bgs)

LOGGED BY Brian Bass
 DATE 10.06.11
 EQUIPMENT 8" Hollow-stem Auger
 DRILLER ABC Liovin Drilling, Inc.

GROUND CONDITION
Native Ground

COORDINATES OF LOCATION
37.9095°N, 119.0643°E
 GROUND ELEVATION
6,825 ft amsl (est. by GPS)

DEPTH (FEET)	GRAPHIC LOG	USCS SOIL CLASS	WELL COMPLETION	DESCRIPTION OF MATERIAL
0		ML		Poorly-graded fine sandy SILT (ML) with some coarse sand and little pebbles; light gray; loose; dry; non-plastic
5				With trace gravel; brown @ 6'
10				Damp @ 10'
15				No sand, no pebbles, and no gravel; very light gray; dry @ 16'
20				With very fine sand and trace pebbles; brown; damp @ 21'
25				With some coarse sand, some pebbles, and some gravel @ 26'
30				
35				
40				

GROUND WATER ENCOUNTERED: n/a	SCREEN MATERIAL: 3/4" Sch. 40 PVC 0.020" machine slots SYMBOL: 5 - 10 ft bgs 30 - 35 ft bgs	WELL CONSTRUCTION MATERIAL: Blank PVC SYMBOL: 0 - 5 ft bgs 0 - 30 ft bgs	BACKFILL MATERIAL: Cuttings SYMBOL: 10 - 24 ft bgs
GROUND WATER STATIC: n/a	FILTER MATERIAL: 3/8" rock SYMBOL: 4.5 - 10 ft bgs 29 - 35 ft bgs	GROUT MATERIAL: n/a SYMBOL:	WELL HEAD PROTECTION MATERIAL: 10" dia. steel monument HEIGHT: n/a
TOTAL DEPTH DRILLED: 35 ft bgs	SURFACE PLUG MATERIAL: n/a SYMBOL:	SEAL MATERIAL: Bentonite chips SYMBOL: 0 - 4.5 ft bgs 24 - 29 ft bgs	WELL CASING DETAILS MATERIAL: PVC HEIGHT: 24" - 36" above ground

Feet (ft) below ground surface (bgs)

LOGGED BY Brian Bass

GROUND CONDITION

COORDINATES OF LOCATION

DATE 10.06.11

Native Ground

37.9077°N, 119.0643°E

EQUIPMENT 8" Hollow-stem Auger

GROUND ELEVATION

DRILLER ABC Liovin Drilling, Inc.

6,822 ft amsl (est. by GPS)

DEPTH (FEET)	GRAPHIC LOG	USCS SOIL CLASS	WELL COMPLETION	DESCRIPTION OF MATERIAL
0		ML		Poorly-graded fine sandy SILT (ML) with trace pebbles; brown; loose; damp; non-plastic
5				Light gray; no pebbles @ 5'
10				Little pebbles and trace gravel @ 12'
15		SP		Poorly-graded fine SAND (SP) with silt and some gravel; grayish-brown; loose; damp; non-plastic
20				
25		SW		Well-graded fine to coarse SAND (SW) with some pebbles and some gravel; grayish-brown; loose; damp; non-plastic
30				
35				

GROUND WATER ENCOUNTERED: n/a	SCREEN MATERIAL: 3/4" Sch. 40 PVC 0.020" machine slots SYMBOL: 5 - 10 ft bgs 27 - 32 ft bgs	WELL CONSTRUCTION MATERIAL: Blank PVC SYMBOL: 0 - 5 ft bgs 0 - 27 ft bgs	BACKFILL MATERIAL: Cuttings SYMBOL: 10 - 21 ft bgs
GROUND WATER STATIC: n/a	FILTER MATERIAL: 3/8" rock SYMBOL: 4.5 - 10 ft bgs 26 - 32 ft bgs	GROUT MATERIAL: n/a SYMBOL:	WELL HEAD PROTECTION MATERIAL: 10" dia. steel monument HEIGHT: n/a
TOTAL DEPTH DRILLED: 32 ft bgs	SURFACE PLUG MATERIAL: n/a SYMBOL:	SEAL MATERIAL: Bentonite chips SYMBOL: 0 - 4.5 ft bgs 21 - 26 ft bgs	WELL CASING DETAILS MATERIAL: PVC HEIGHT: 24" - 36" above ground
Feet (ft) below ground surface (bgs)			

LOGGED BY Brian Bass

GROUND CONDITION Native Ground

COORDINATES OF LOCATION

DATE 10.06.11

37.9059°N, 119.0643°E

EQUIPMENT 8" Hollow-stem Auger

GROUND ELEVATION
6,825 ft amsl (est. by GPS)

DRILLER ABC Liovin Drilling, Inc.

DEPTH (FEET)	GRAPHIC LOG	USCS SOIL CLASS	WELL COMPLETION	DESCRIPTION OF MATERIAL	
0		ML		Poorly-graded fine sandy SILT (ML) with some pebbles; gray; loose; dry; non-plastic	
5					
10					Light gray @ 14'
15					
20				Trace pebbles and trace gravel @ 22'	
25				Little pebbles and little gravel @ 25'	
30					

GROUND WATER ENCOUNTERED: n/a	SCREEN MATERIAL: 3/4" Sch. 40 PVC 0.020" machine slots SYMBOL: 5 - 10 ft bgs 21 - 26 ft bgs	WELL CONSTRUCTION MATERIAL: Blank PVC SYMBOL: 0 - 5 ft bgs 0 - 21 ft bgs	BACKFILL MATERIAL: Cuttings SYMBOL: 10 - 15 ft bgs
GROUND WATER STATIC: n/a	FILTER MATERIAL: 3/8" rock SYMBOL: 4.5 - 10 ft bgs 20 - 26 ft bgs	GROUT MATERIAL: n/a SYMBOL:	WELL HEAD PROTECTION MATERIAL: 10" dia. steel monument HEIGHT: n/a
TOTAL DEPTH DRILLED: 26 ft bgs	SURFACE PLUG MATERIAL: n/a SYMBOL:	SEAL MATERIAL: Bentonite chips SYMBOL: 0 - 4.5 ft bgs 15 - 20 ft bgs	WELL CASING DETAILS MATERIAL: PVC HEIGHT: 24" - 36" above ground

Feet (ft) below ground surface (bgs)

LOGGED BY Brian Bass

GROUND CONDITION

COORDINATES OF LOCATION

DATE 10.07.11

Native Ground

37.9059°N, 119.0676°E

EQUIPMENT 8" Hollow-stem Auger

GROUND ELEVATION

DRILLER ABC Liovin Drilling, Inc.

6,820 ft amsl (est. by GPS)

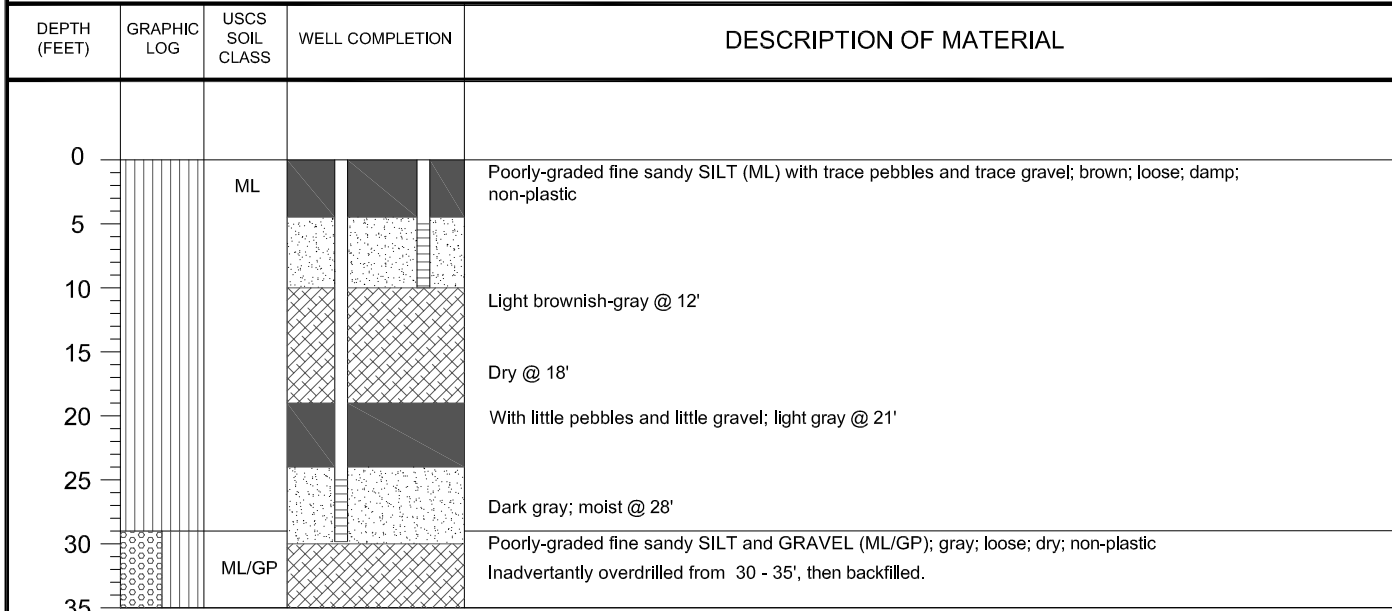

GROUND WATER ENCOUNTERED: n/a	SCREEN MATERIAL: 3/4" Sch. 40 PVC 0.020" machine slots SYMBOL: 5 - 10 ft bgs 25 - 30 ft bgs	WELL CONSTRUCTION MATERIAL: Blank PVC SYMBOL: 0 - 5 ft bgs 0 - 25 ft bgs	BACKFILL MATERIAL: Cuttings SYMBOL: 10 - 19 ft bgs 30 - 35 ft bgs
GROUND WATER STATIC: n/a	FILTER MATERIAL: 3/8" rock SYMBOL: 4.5 - 10 ft bgs 24 - 30 ft bgs	GROUT MATERIAL: n/a SYMBOL:	WELL HEAD PROTECTION MATERIAL: 10" dia. steel monument HEIGHT: n/a
TOTAL DEPTH DRILLED: 35 ft bgs	SURFACE PLUG MATERIAL: n/a SYMBOL:	SEAL MATERIAL: Bentonite chips SYMBOL: 0 - 4.5 ft bgs 19 - 24 ft bgs	WELL CASING DETAILS MATERIAL: PVC HEIGHT: 24" - 36" above ground

Feet (ft) below ground surface (bgs)

ATTACHMENT 4, AS-BUILT REPORT – PUMICE VALLEY LANDFILL SITE PHOTOGRAPHS
LFG Well Installation Project – Mono County, California

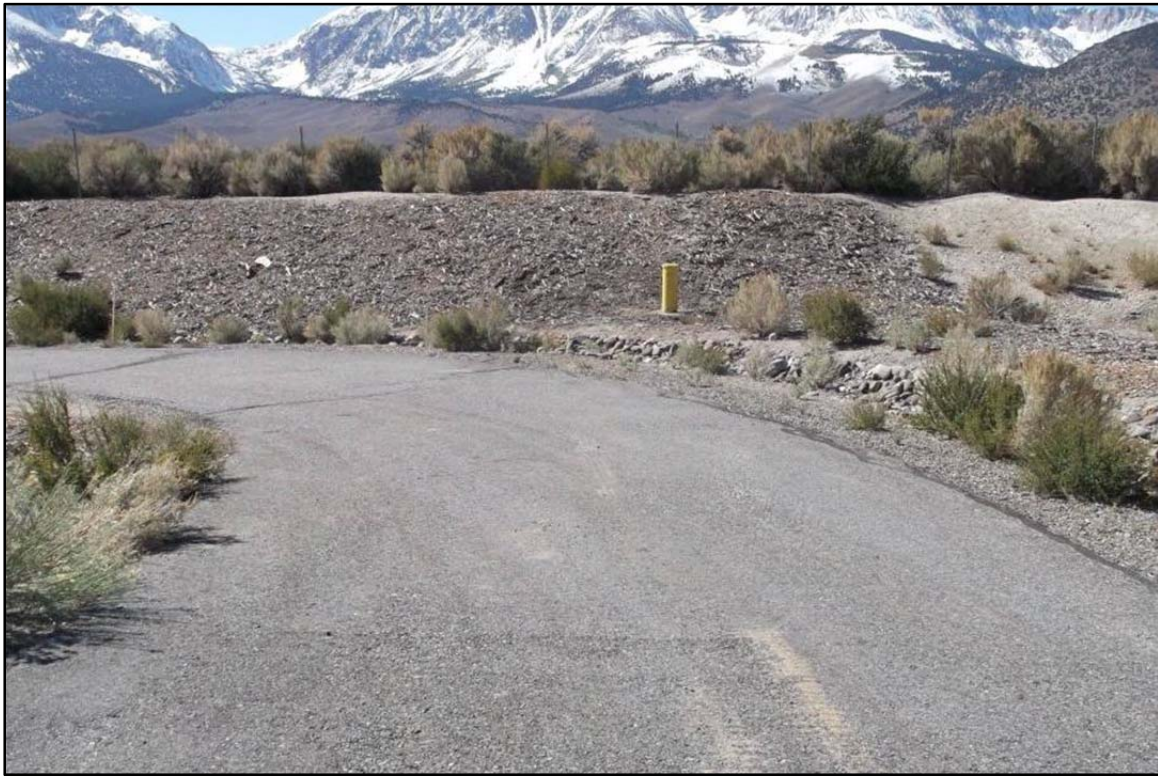

Plate 4-1. Landfill gas monitoring well GW-1 (view west).



Plate 4-2. LFG monitoring well GW-2 from ground water monitoring well MW-4 (view west).

ATTACHMENT 4, AS-BUILT REPORT – PUMICE VALLEY LANDFILL SITE PHOTOGRAPHS
LFG Well Installation Project – Mono County, California



Plate 4-3. Landfill gas monitoring well GW-3 (view east).



Plate 4-4. Landfill gas monitoring well GW-4 (view north).

ATTACHMENT 4, AS-BUILT REPORT – PUMICE VALLEY LANDFILL SITE PHOTOGRAPHS
LFG Well Installation Project – Mono County, California



Plate 4-5. Landfill gas monitoring well GW-5 (view north).



Plate 4-6. LFG monitoring well GW-6 at ground water monitoring well MW-1 (view southeast).

ATTACHMENT 4, AS-BUILT REPORT – PUMICE VALLEY LANDFILL SITE PHOTOGRAPHS
LFG Well Installation Project – Mono County, California

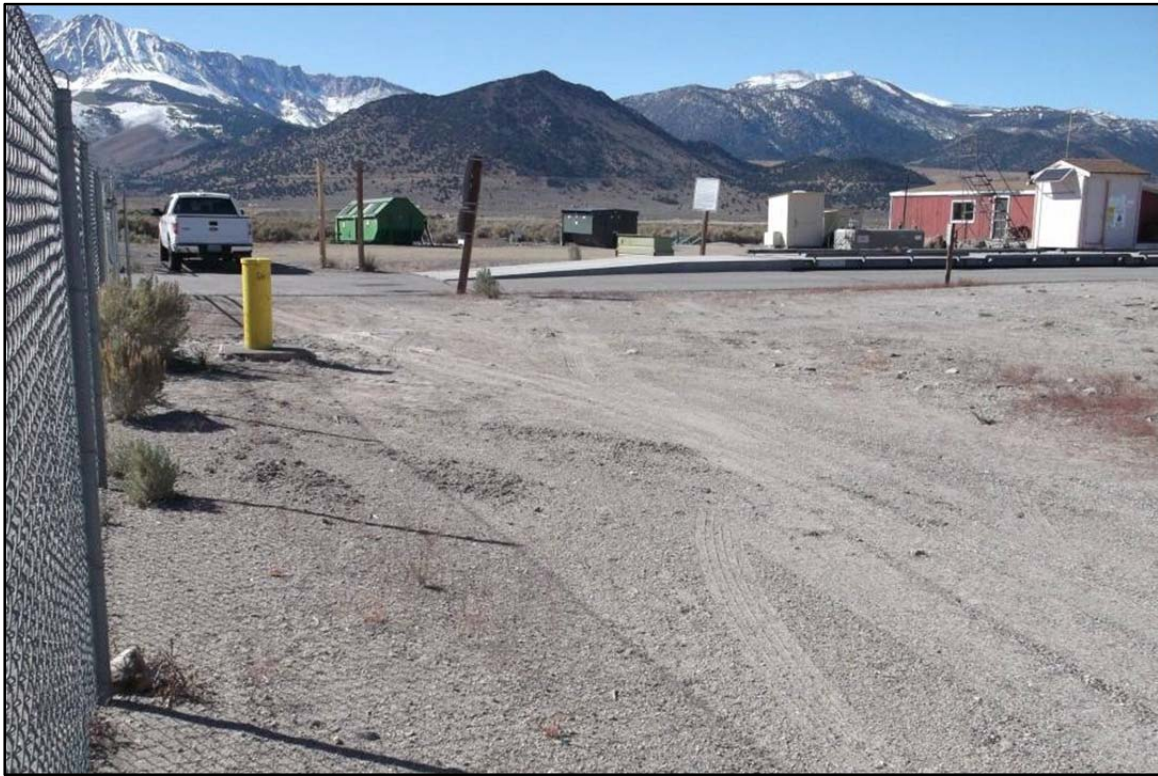

Plate 4-7. Landfill gas monitoring well GW-7 at site entrance (view west).

APPENDIX D

Load Checking Program

**LOAD CHECKING PROGRAM
FOR THE
WALKER LANDFILL**



February 2013

TABLE OF CONTENTS

	<u>Page</u>
1.0 INTRODUCTION.....	1
2.0 ACCEPTED WASTES.....	1
3.0 PROHIBITED WASTES.....	3
4.0 PROHIBITED WASTE EXCLUSION PROGRAM.....	5
5.0 NOTIFICATION.....	7
6.0 TRAINING.....	7
7.0 RECORD-KEEPING AND REPORTING.....	8
8.0 HEALTH AND SAFETY.....	ERROR! BOOKMARK NOT DEFINED.

1.0 INTRODUCTION

The Mono County Department of Public Works, Solid Waste Division (Division), has implemented this Load-Checking Program at the Walker Landfill in accordance with Title 27, California Code of Regulations (27 CCR), Section 20870, which requires that all municipal solid waste landfills institute a program for detecting and preventing the disposal of regulated hazardous waste and polychlorinated biphenyl (PCB) wastes. This program includes the following elements:

- Routine visual inspections of all incoming loads;
- Periodic physical inspections of random incoming loads;
- Records of inspections;
- Training of facility personnel to recognize and properly manage hazardous and PCB wastes; and,
- Notification requirements in the event that hazardous or PCB wastes are identified at the facility.

The following sections present information necessary for the proper implementation of this Load-Checking Program.

2.0 ACCEPTED WASTES

Table 2.1 presents a detailed summary of the types of waste accepted for disposal or management at the landfill and transfer station portions of the Walker disposal site. In general, they are:

- Non-hazardous solid waste in accordance with 27 CCR Section 20220, including:
 - Inert debris and construction and demolition (C&D) waste;
 - Wood and green waste;
 - Scrap metal and large household appliances (white goods);
 - Waste tires;
 - Treated medical waste rendered into solid waste pursuant to the Medical Waste Management Act (Division 104, California Health and Safety Code);
- CRTs, electronic waste, used motor oil, household hazardous waste, Universal waste

Table 2.1. List of Acceptable Wastes

Category	Waste Material
<p>Municipal Solid Waste, Construction and Demolition (C&D) Waste</p>	<ul style="list-style-type: none"> • Food and food products • Paper (newspaper, office paper, paper products) • Cardboard, boxboard • Tin, sheet metal • Dried empty paint cans • Rubber products • Dirt, concrete, asphalt, construction rebar, rocks • Roofing paper, shingles (non-asbestos) • Plant residues of agricultural origin • Styrofoam • Fabric, clothing, textiles • Glass, porcelain, ceramics • Yard trimmings, wood waste, scrap lumber • Sheetrock, drywall • Furniture, carpet • PVC plastic, plastic • Empty containers
<p>Other Wastes</p>	<ul style="list-style-type: none"> • Tires (diverted whole, must be sliced or sheared for burial) • Any containers used for liquid or dry chemicals must be empty, dry, and have been processed by rinsing and draining, or decontaminated by other LEA-approved methods. • Triple-rinsed empty pesticide containers. • Treated medical wastes (if rendered non-infectious via autoclave or other LEA-approved treatment method). No red bags, sharp medical instruments, or containers allowed without evidence of effective treatment. • Dirt and other construction wastes may not be contaminated with petroleum products or other hazardous material or hazardous wastes. • Empty containers (i.e., aerosol cans, paint cans) or containers with dry materials (i.e., solid paint).

3.0 PROHIBITED WASTES

The following waste types are not accepted for disposal at the Walker Landfill:

- Hazardous waste as defined in 22 CCR, Division 4.5, Chapter 11, Article 1;
- Non-friable asbestos is acceptable if wrapped in heavy plastic, taped, or otherwise secured for immediate burial (friable asbestos not accepted for disposal).
- Designated waste as defined in 27 CCR Section 20210;
- Friable asbestos-containing waste;
- Untreated medical waste (including sharps or containers without evidence of treatment); and,
- Liquid or semi-solid waste with a solids content of less than 50 percent by weight.

Table 3.1 presents a detailed summary of typical wastes prohibited from disposal. These wastes are removed from the waste stream by either the customer or the gate attendant and temporarily stored by the gate attendant at the on-site household hazardous waste (HHW) storage lockers.

Table 3.1. List of Typical Prohibited Wastes

Category	Waste Material
Automotive Supplies	<ul style="list-style-type: none"> • Antifreeze • Air-conditioning refrigerant • Fuel additives and starter fluid • Grease and rust solvents • Transmission and brake fluid • Used motor oil and oil filters • Lead-acid batteries, battery acid, corrosive battery fluid • Car wax and polish • Lubricating oil • Automotive cleaners (carburetor cleaner, chrome polish) • Gasoline, diesel fuel, fuel wastes • Kerosene, lamp oil • Auto body filler

continued...

Table 3.1 (cont.), List of Typical Prohibited Wastes

Category	Waste Material
<p>Building and Wood-Working Supplies, Surface Treatments</p>	<ul style="list-style-type: none"> • Liquid enamel, latex, acrylic, and water-based paints (dried solids are acceptable) • Paint thinner, turpentine, mineral spirits • Paint or varnish remover, strippers • Wood preservatives (creosote, penta-chlorophenol) • Stains, polyurethanes, finishers • Glue, cement • Rust paints, metal primers • Friable asbestos • Fluorescent lamp tubes and ballasts
<p>Household Cleaners, Hobby Suppliers</p>	<ul style="list-style-type: none"> • Aerosol cans containing any pressure or fluid • Abrasive cleaners and powders, detergent • Adhesives, glues, cements • Butane lighters • Chemistry sets • Oven cleaner • Toilet cleaner • Bleach cleaners • Ammonia-based cleaners • Rug and upholstery cleaners • Resins, fiberglass, epoxy (dried solids are acceptable) • Mothballs and flakes • Pharmaceuticals (chemotherapy drugs) • Broken thermometers with mercury • Disinfectants • Photographic chemicals and solutions • Rubber cement thinner • Shoe dye, polish and paste • Spot removers • Nail polish, polish remover, cuticle remover • Furniture and floor polish • Hair permanent, colorant, and straightener solutions • Clothing and chemical dyes • Printer ink • Pool chemicals • Model glue and paint • Cleaning solvents or acids • Any solvents or acids, other than water

Table 3.1 (cont.), List of Typical Prohibited Wastes

Category	Waste Material
Garden and Pet Supplies	<ul style="list-style-type: none"> • Chemical fertilizers • Fungicides, Herbicides • Pesticides, Insecticides • Ant and roach killers • Pet care products (flea powder, tick powder, shampoo) • Rat, mouse, and gopher poisons • Snail and slug poisons • Soil fumigants
Other Wastes	<ul style="list-style-type: none"> • Caustic sludge and wastewater • Acid sludge • Alkaline, caustic liquids • Fly ash • Lime and sulfur sludge • Soda ash • Used chemical solutions (cyanide, used acids) • Chemical toilet and septic tank pumpings • Pickling liquor • Air-reactive or water-reactive solids or liquids • Flammable gases, liquids, or solids • Freon gas and fluids from appliances • Compressed gases (flammable or non-flammable) • Corrosives • Oxidizers, organic peroxides • Poison gases • Radioactive wastes • Mercury • Ammunition, gun powder • Explosives • Liquids

4.0 PROHIBITED WASTE EXCLUSION PROGRAM

Signs posted at the landfill entrance describe the general types of waste that are accepted for disposal and those that are prohibited. However, because of the rural nature of the county and the potential for illegal disposal that it presents, Mono County has adopted a policy of accepting hazardous wastes that are source-separated and delivered by residential customers and small quantity generators. This material is periodically transferred to the County’s permanent HHW facility (PHHWF) at the Benton Crossing Landfill for proper management, including consolidation.

By conducting both routine visual load inspections and random physical load inspections, the prohibited waste exclusion program effectively educates customers as to what types of waste should be separated and set aside prior to arrival at the landfill. The gate attendant asks all incoming contractors and self-haul customers what type of waste they are hauling and whether it contains any liquids, paints, batteries, televisions, motor oil, or other prohibited waste. All open-top loads are visually inspected at the scalehouse for the presence of hazardous or prohibited materials.

A minimum of one customer load, including self-haulers, contractors, dump trucks, and roll-off trucks, is randomly selected every two weeks for a thorough physical inspection. At the landfill, a selected load is carefully dumped and spread in a windrow adjacent to the working face and away from traffic lanes, then inspected for the presence of hazardous or prohibited wastes. Selected loads at the transfer station are physically inspected at the tipping pad. Basic information about the customer is obtained (e.g., waste source, vehicle make, model, and license, contact telephone number), and the customer is asked to wait while the inspection is performed. In addition to meeting compliance with State solid waste regulations, the process is used as a means to educate the customer. Manageable quantities of prohibited materials discovered in a load are set aside until completion of the inspection, and then transferred to the on-site HHW storage lockers for management. Loads suspected of containing hazardous waste are treated as such until a determination can be made.

If waste found in private or commercial haul vehicles is determined to be acceptable, it is transferred to either the municipal waste compactor at the transfer station or the construction and demolition working face for disposal. If prohibited waste is discovered in a load, the hauler is informed as to what has been found, instructed to set similar waste aside in the future for proper management at the landfill, and furnished with a list of common wastes that are prohibited. Due to the low traffic volume and because detailed records are kept, suspect or prohibited wastes discharged at the site can usually be traced back to the hauler. A waste source that has had prohibited waste discovered in its load will typically be targeted for a follow-up physical load inspection in the near future to ensure that the customer recognizes the importance of removing prohibited materials from the waste stream.

When compacting the working face, loads are carefully spread for observation using a dozer. Containers with contents that are not easily identifiable, such as unmarked 55-gallon drums, are separated if a visual inspection determines that such movement will

not cause the container to rupture, and will be opened and inspected only by properly-trained personnel.

Tests for hazardous characteristics are performed to classify unknown waste removed through the load-checking program. Classification methods typically consist of using pH paper followed by tests for corrosiveness, flammability, and reactivity. If prohibited waste discovered at the site is outside the scope of the HHW program and beyond the capabilities and training of site personnel, Division staff will call 911, implement the facility's *Emergency Response Plan*, and complete required notifications in accordance with Section 5.0 of this plan. Landfill personnel will immediately take any necessary steps to protect public health and safety and the environment, but will only participate in response activities as directed by First Responders.

Hazardous wastes temporarily stored on-site are periodically removed by landfill personnel and hauled to the PHHWF at the Benton Crossing Landfill for proper management and storage, where it is:

- Properly stored at the HHW facility in accordance with permit conditions;
- Properly manifested;
- Removed by a licensed transporter; and,
- Disposed or recycled at a permitted treatment, storage, or disposal (TSD) facility.

5.0 NOTIFICATION

In the event prohibited waste discovered at the site is outside the scope of the HHW program and beyond the capabilities and training of landfill personnel, site personnel will contact the Solid Waste Superintendent, who will then notify the following regulatory agencies within seven days:

- Local Enforcement Agency (Mono County Health Department);
- California Department of Toxic Substances Control; and,
- Lahontan Regional Water Quality Control Board.

6.0 TRAINING

All Walker Landfill personnel (including gate personnel provided by the transfer station contractor) are routinely trained and certified in load-checking procedures through an on-going process of on-the-job, in-house, and external course training. Load-check training addresses hazardous waste identification, proper waste handling and storage methods, safety precautions, and record-keeping requirements detailed in this plan and in the *Emergency Response Plan*. Training is performed both by qualified in-house

instructors and by experienced contractors, and typically includes published materials, audio/visual resources, hands-on classification testing, and field work as teaching aids. Training documentation for each employee is entered into the operating record for the facility. Given their potential exposure to hazardous substances, landfill personnel may also receive 40-hour certification training in *Hazardous Waste Operations and Emergency Response* (HAZWOPER) standards, consistent with Title 29, Part 1910.120 of the Code of Federal Regulations (29 CFR 1910.120). Those that have received HAZWOPER training are also provided with annual 8-hour refresher training in appropriate subject matters to keep their certification current.

7.0 RECORD-KEEPING AND REPORTING

Inspection records are completed by site personnel performing random physical load inspections. These records, which are compiled for every physical load inspection, will include the following data:

- date and time the load was inspected;
- name(s) of inspector(s);
- a description of the contents of the load;
- load origin, including company contact information (if applicable);
- vehicle driver's name and telephone number;
- vehicle make, model, and license plate number;
- observations made by the inspector;
- description and quantity of rejected material(s), if any; and,
- additional relevant comments.

Copies of the forms, *Load Inspection Report* and *Daily Activity Log*, used at the Walker Landfill are included in the RDSI as **Appendix F**. Inspection records and documentation of notifications in accordance with Section 5.0 will be placed in the operating record for the facility at the office of the Mono County Department of Public Works.

APPENDIX E

Record Keeping Forms

DAILY ACTIVITY LOG

Mono County Solid Waste Program

Facility Location: BT BX BP CH PR PV WK

Date: ___ / ___ / ___ Mon. Tue. Wed. Thu. Fri. Sat. Sun.

Staff: _____ Open: _____ a.m. Closed: _____ p.m.

START OF DAY CHECK:

Gate Security: Okay See Notes Illegal Dumping: None See Notes

Perimeter Fencing: Okay See Notes Vandalism: None See Notes

Equipment Check: Okay See Notes Posted Signs: Okay See Notes

Notes: _____

Weather (a.m.): Hot Warm Cool Cold Breezy Windy
 Sunny Overcast Rain Snow Other: _____

Weather (p.m.): Hot Warm Cool Cold Breezy Windy
 Sunny Overcast Rain Snow Other: _____

SUMMARY OF DAILY ACTIVITIES:

Litter: _____

Load-Checking: Routine Visual at Gate Physical Inspection Prohibited Waste Found

SPECIAL EVENT / INJURY / ACCIDENT / INCIDENT REPORT: (Describe Event, Damage, Outcome)

LOAD INSPECTION REPORT

Mono County Solid Waste Program

Landfill: BX PV WK
Transfer Station: BT BP CH PR PV WK

Date: ___ / ___ / ___ Time: _____ Inspector: _____

WASTE HAULER INFORMATION:

Driver's Name: _____ Phone: _____ Inspection: Visual Physical
Company Name: _____ Phone: _____ Contact: _____
Vehicle Lic. No.: _____ Make: _____ Model: _____

WASTE SOURCE INFORMATION:

Company Name: _____ Phone: _____ Contact: _____
Mailing Address: _____ City: _____ Title: _____

DISPOSITION OF WASTE LOAD:

- Waste Deemed Acceptable – Relocated to Proper Disposal Area
- Prohibited Waste Suspected – Isolated Pending Determination
- Prohibited Waste Detected – Commercial Source – Hauler Contacted for Removal
- Prohibited Waste Detected – Residential Source – Relocated to Storage: ID#: _____ Tub #: _____
- Other: _____

DESCRIPTION OF PROHIBITED WASTE FOUND:

<u>Solid</u>	<u>Liquid</u>	<u>Gas</u>	<u>Product Name / Chemical / Description</u>	<u>Quantity</u>	<u>Unit</u>	<u>Comment</u>
<input type="checkbox"/>	<input type="checkbox"/>	<input type="checkbox"/>	_____	_____	_____	_____
<input type="checkbox"/>	<input type="checkbox"/>	<input type="checkbox"/>	_____	_____	_____	_____
<input type="checkbox"/>	<input type="checkbox"/>	<input type="checkbox"/>	_____	_____	_____	_____
<input type="checkbox"/>	<input type="checkbox"/>	<input type="checkbox"/>	_____	_____	_____	_____
<input type="checkbox"/>	<input type="checkbox"/>	<input type="checkbox"/>	_____	_____	_____	_____
<input type="checkbox"/>	<input type="checkbox"/>	<input type="checkbox"/>	_____	_____	_____	_____

ADDITIONAL COMMENTS OR FOLLOW-UP:

(Attach Photos or Other Documentation)

COMMON HOUSEHOLD HAZARDOUS WASTES

CORROSIVES (ACIDS)

Boric Acid
Car Battery Acid
Copper Cleaners
Etching Solutions
Ferric Chloride
Fertilizers *
Hydrochloric Acid
Hydrofluoric Acid
Metal Cleaners
Muriatic Acid
Navel Jelly
Phosphoric Acid
Pool Acid
Sheep Dip
Sodium Bisulfate
Sulfuric Acid
Toilet Bowl Cleaners *

CORROSIVES (BASES)

Ammonia
Ammonia-Based Cleaners
Battery Terminal Cleaner
Caustic Soda
Cess Pool Cleaners *
Drain Cleaners *
Household Cleaners
Lime
Lye
Oven Cleaners *
Sodium Hydroxide
Window Cleaners

OXIDIZERS

Ammonium Nitrate
Bleach
Calcium Hypochlorite
Chlorates
Fertilizers *
Fluorine
Hair Coloring
Hydrogen Peroxide
Iodine
Nitric Acid
Plant Food
Potassium Permanganate
Sodium Hypochlorite
Toilet Bowl Cleaner w/Bleach

ORGANIC PEROXIDE

Adhesive Catalysts
Auto Body Filler (Bondo) Catalyst
Tree Root / Stump Killer

EXPLOSIVES

Ammunition
Fireworks
Flares

RADIOACTIVE MATERIALS

Luminescent Dial Watches
Smoke Alarms

*Check ingredients to be sure.

FLAMMABLES & COMBUSTIBLES

Acetone
Adhesives *
Aerosols
Air Freshener
Alcohols
Ashphalt Driveway Topping
Auto Body Filler (Bondo)
Automotive Oils
Automotive Waxes
BBQ Lighter Fluid
Benzene
Brake Fluid
Camphor
Chrome-Silver Polishes *
Cutting Oil
Dap *
Denatured Alcohol
Diesel Fuel
Disinfectants
Duplicator Fluid
Enamel Paint (unsolidified)
Enamel / Oil Base Paint
Epoxy Paint (unsolidified)
Ethanol
Ether
Ethylene Glycol
Fiberglass Resins (unsolidified)
Fingernail Polish & Remover
Floor / Furniture Polish
Formaldehyde Solution
Gasoline
Glues *
Grease
Household Waxes
Isopropyl Alcohol
Kerosene
Lacquer Thinner
Lacquer Paint (unsolidified)
Linseed Oil
Liquid Waxes *
Liquid Sandpaper *
Liquid Butane
Methanol
Methylene Chloride
Naphtha
Oils (Petroleum)
Organic Solvents
Paint Thinners
Paint Strippers *
Paraffin Oil
Pentachlorophenol
Perfume
Petroleum Distillates
Plastic Model Cement
Polyurethane Paint (unsolidified)
Polyurethane Cement (unsolidified)
Power Steering Fluid
Primers
Roofing Cement
Rug / Upholstery Cleaner
Sealers
Shellac Thinner
Silicone Sprays

FLAMMABLES, continued...

Spot Remover / Dry Clean Fluid
Tile Cement
Tire Black
Toluene / Toluol
Transmission Fluid / Oil
Turpentine
Varnish
Wallpaper Cement
Windshield Washer Fluid
WD-40
White Gas
Wood Filler / Putty
Wood Stain
Xylene / Xylol

POISONS

Ant and Roach Killer
Antifreeze
Arsenic Compounds
Automotive Cleaners
Bacterial Pipe Cleaners
Black Flag
Bordeaux Mix
Boric Acid
Bug Remover
Chlordane
Chrome-Silver Polishes *
Chromium
Copper Sulfate
DDT
Diazinon
Dimethylamine Salts
Disinfectants *
Dog Repellent
Ethylene Glycol
Fertilizers
Flea Spray / Powder
Fungicides *
Gopher / Mole Killer
Insect Sprays
Latex / Water-Based Paints
Lead Compounds
Lice Powder
Lindane
Malathion
Mercury
Moth Crystals
OFF Insect Spray
Pentachlorophenol
Pesticides
Pharmaceuticals
Plant Food
Pruning Paint
Raid
Rat Poison
Rose Dust
Round-Up
Seven Dust / Spray
Snail / Slug Killer
Strychnine
Tar Remover
Weed / Grass Killer
Windshield Washer Fluid

CRT ACCEPTANCE LOG

Mono County Solid Waste Program

Location: BT BX BP CH PR PV WK

Date: _____ No. of CRTs: _____ Customer Name: _____

Phys. Address: _____ Town: _____ Zip: _____

Date: _____ No. of CRTs: _____ Customer Name: _____

Phys. Address: _____ Town: _____ Zip: _____

Date: _____ No. of CRTs: _____ Customer Name: _____

Phys. Address: _____ Town: _____ Zip: _____

Date: _____ No. of CRTs: _____ Customer Name: _____

Phys. Address: _____ Town: _____ Zip: _____

Date: _____ No. of CRTs: _____ Customer Name: _____

Phys. Address: _____ Town: _____ Zip: _____

Date: _____ No. of CRTs: _____ Customer Name: _____

Phys. Address: _____ Town: _____ Zip: _____

Date: _____ No. of CRTs: _____ Customer Name: _____

Phys. Address: _____ Town: _____ Zip: _____

Date: _____ No. of CRTs: _____ Customer Name: _____

Phys. Address: _____ Town: _____ Zip: _____

USED OIL ACCEPTANCE LOG

Mono County Solid Waste Program

Location: BT BX BP CH PR PV WK

Date: _____ Vol. Oil: _____ gal. Name: _____

Initials: _____ Filters: _____ ea. Phone: _____

Reason(s) If Rejected: Odor Color Layered Viscosity Other: _____

Date: _____ Vol. Oil: _____ gal. Name: _____

Initials: _____ Filters: _____ ea. Phone: _____

Reason(s) If Rejected: Odor Color Layered Viscosity Other: _____

Date: _____ Vol. Oil: _____ gal. Name: _____

Initials: _____ Filters: _____ ea. Phone: _____

Reason(s) If Rejected: Odor Color Layered Viscosity Other: _____

Date: _____ Vol. Oil: _____ gal. Name: _____

Initials: _____ Filters: _____ ea. Phone: _____

Reason(s) If Rejected: Odor Color Layered Viscosity Other: _____

Date: _____ Vol. Oil: _____ gal. Name: _____

Initials: _____ Filters: _____ ea. Phone: _____

Reason(s) If Rejected: Odor Color Layered Viscosity Other: _____

Date: _____ Vol. Oil: _____ gal. Name: _____

Initials: _____ Filters: _____ ea. Phone: _____

Reason(s) If Rejected: Odor Color Layered Viscosity Other: _____

Acceptable Fluids:

Motor Oils
Gear Box Oils
Transmission Fluids

Unacceptable Fluids:

Solvents	Brake Fluid	Paint & Lacquer Thinners
Gasoline	Anti-Freeze	Household Chemicals
Water	Paints & Varnishes	Pesticides & Insecticides

HOUSEHOLD HAZARDOUS WASTE TRANSFER FORM

Mono County Solid Waste Program

Hauled From: BT BX BP CH PR PV WK By (initial): _____

Date: ____ / ____ / ____ Delivered To: BX or, _____

PAINTS & STAINS

CRTs / BATTERIES / OTHER

Pints: _____ 5 Gallon: _____

CRTs: _____ Auto Batteries: _____

Quarts: _____ Aerosol Cans: _____

Oil Filters: _____ NiCad Batteries: _____

1 Gallon: _____ Other: _____

Fluor. Tubes: _____ Alk. Batteries: _____

ACID CORROSIVES & OXIDIZERS

BASE CORROSIVES & OXIDIZERS

POISONS & PESTICIDES

FLAMMABLES

NEUTRALS

FACILITY VISITOR'S LOG

Mono County Solid Waste Program

Location: BT BX BP CH PR PV WK

Date: ___ / ___ / ___ Time In: _____ Visitor(s): _____
Time Exit: _____ Company: _____
Phone: _____ Purpose: _____

Date: ___ / ___ / ___ Time In: _____ Visitor(s): _____
Time Exit: _____ Company: _____
Phone: _____ Purpose: _____

Date: ___ / ___ / ___ Time In: _____ Visitor(s): _____
Time Exit: _____ Company: _____
Phone: _____ Purpose: _____

Date: ___ / ___ / ___ Time In: _____ Visitor(s): _____
Time Exit: _____ Company: _____
Phone: _____ Purpose: _____

Date: ___ / ___ / ___ Time In: _____ Visitor(s): _____
Time Exit: _____ Company: _____
Phone: _____ Purpose: _____

Date: ___ / ___ / ___ Time In: _____ Visitor(s): _____
Time Exit: _____ Company: _____
Phone: _____ Purpose: _____

Date: ___ / ___ / ___ Time In: _____ Visitor(s): _____
Time Exit: _____ Company: _____
Phone: _____ Purpose: _____

TRAINING / SAFETY MEETING RECORD

Mono County Solid Waste Program

Facility Location: BT BX BP CH PR PV WK

Date: _____ Time: _____ Conducted By: _____

MEETING ATTENDEES

Print or Type Name	Signature
1. _____	_____
2. _____	_____
3. _____	_____
4. _____	_____
5. _____	_____
6. _____	_____

TOPICS OF DISCUSSION

- | | |
|---|---|
| 1. _____ | 4. <u>Property Damage Since Last Safety Meeting</u> |
| 2. <u>Safety Hazards Identified Since Last Mtg.</u> | 5. <u>Close Calls Since Last Safety Meeting</u> |
| 3. <u>Injuries Since Last Safety Meeting</u> | 6. <u>Safety Issues Related to Upcoming Tasks</u> |

RESOURCES USED (i.e., video, handouts – attach copy)

- | | |
|----------|----------|
| 1. _____ | 3. _____ |
| 2. _____ | 4. _____ |

SUMMARY OF DISCUSSION

MONO COUNTY ROAD DEPARTMENT

VEHICLE SERVICE CHECKLIST

VEHICLE NO. _____ DATE _____

VEHICLE MILEAGE _____ DEPARTMENT _____

WORK REQUESTED BY _____

STANDARD LUBE/CHECKS

- _____ LUBE CHASSIS
- _____ CHANGE OIL
- _____ CHANGE FILTERS

SAFETY CHECKS

- _____ STEERING
- _____ SUSPENSION

FLUID LEVEL CHECK

- _____ BRAKE
- _____ COOLANT
- _____ POWER STEERING
- _____ TRANSMISSION
- _____ BATTERY WATER
- _____ DIFFERENTIAL/GEAR BOXES
- _____ WINDSHIELDS

_____ U-JOINT/DRIVELINE

TIRES

_____ TIRE ROTATION

SAFETY CHECKS

- _____ WINDSHIELD WIPER BLADES
- _____ BELTS
- _____ HOSES
- _____ LIGHTS/LAMPS
- _____ HORN
- _____ SEAT BELTS
- _____ GLASS

- _____ TURNING SIGNALS
- _____ MIRRORS
- _____ JACK IN TRUNK

- _____ SPARE TIRE INFLATION
- _____ BRAKE SHOE INSPECTION

NOTES _____

MECHANIC _____

**MONO COUNTY PUBLIC WORKS
REPAIR REQUEST**

PRE/POST OPERATION CHECKLIST

UNIT NO. _____ DISTRICT _____ TROUBLE SYMPTOMS: _____

HRS./MI. _____

CODE: INSPECTED AND OK () _____

REPAIR NEEDED (R) _____

OIL _____

WATER _____

ENGINE COMPARTMENT (Battery, _____

loose items, leaks, belts, etc.) _____

CLEAN CAB INTERIOR-no loose items _____

START ENGINE-OBSERVE GAGES _____

WINDOWS, MIRRORS, WIPERS, HORN _____

LIGHTS-AMBER, BRAKE, SIGNAL, ETC. _____

TIRES-(LUG NUTS 1-Ton and above) _____

GENERAL EXTERIOR CONDITION (Body _____

damage, flaps, missing bolts, etc.) _____

CUTTING EDGES, BLADES, TEETH, SHOES _____

SERVICE & PARKING BRAKE, DRAIN TANKS _____ OPERATE "AS IS" UNTIL _____

BACK ALARM _____

SEAT BELTS _____

STEAM CLEAN-WEEKLY _____

I have made the above inspections.

OPERATOR: _____

APPROVED BY: _____

Supervisor

REPAIRED BY: _____

DATE: _____

RETURNED TO SERVICE: _____

INTERNAL USE *ONLY!*

INCIDENT/HAZARD REPORT

(COUNTY) Mono

SECTION A		<input type="checkbox"/> INJURY INCIDENT	<input type="checkbox"/> INCIDENT/NEAR MISS	<input type="checkbox"/> HAZARD	
DATE & TIME OF INCIDENT:		LOCATION:	DATE REPORTED:		
REPORTED TO:		REPORTED BY: (Optional)	DEPARTMENT:		
SECTION B	DESCRIPTION OF INCIDENT - INJURY, INCIDENT/NEAR MISS, HAZARD				
SECTION C	CAUSES				
SECTION D	SUGGESTED CORRECTIONS				
INVESTIGATED BY:		TITLE:	DATE:		
SECTION E	CORRECTIVE ACTION			DATE	
<u>Department Safety Representative Signature:</u>		Date:	<u>Department Head Signature:</u>		Date:

Please send completed original form to Risk Management, Rita Sherman



**EMPLOYEE'S CLAIM FOR
 WORKERS' COMPENSATION BENEFITS**

If you are injured or become ill because of your job, you may be entitled to workers' compensation benefits.

Complete the "Employee" section and give the form to your employer. Keep the copy marked "Employee's Temporary Receipt" until you receive the dated copy from your employer. You may call the Division of Workers' Compensation at **1-800-736-7401** if you need help in filling out this form or in obtaining your benefits. An explanation of workers' compensation benefits is included on the back of this form.

You should also have received a pamphlet from your employer describing workers' compensation benefits and the procedures to obtain them.

**PETICION DEL EMPLEADO PARA BENEFICIOS
 DE COMPENSACIÓN DEL TRABAJADOR**

Si Ud. se ha lesionado o se ha enfermado a causa de su trabajo, Ud. tiene derecho a recibir beneficios de compensación al trabajador.

Complete la sección "Empleado" y entregue la forma a su empleador. Quédese con la copia designada "Recibo Temporal del Empleado" hasta que Ud. reciba la copia fechada de su empleador. Si Ud. necesita ayuda para completar esta forma o para obtener sus beneficios, Ud. puede hablar con la Division de Compensación al Trabajador llamando al **1-800-736-7401**. En la parte de atrás de esta forma se encuentra una explicación de los beneficios de compensación al trabajador.

Ud. también debería haber recibido de su empleador un folleto describiendo los beneficios de compensación al trabajador lesionado y los procedimientos para obtenerlos.

Any person who makes or causes to be made any knowingly false or fraudulent material statement or material representation for the purpose of obtaining or denying workers' compensation benefits or payments is guilty of a felony.

Toda aquella persona que a propósito haga o cause que se produzca cualquier declaración o representación material falsa o fraudulenta con el fin de obtener o negar beneficios o pagos de compensación a trabajadores lesionados es culpable de un crimen mayor "felonia".

Employee: Empleado:

1. Name. *Nombre.* _____ Today's Date. *Fecha de Hoy.* _____

2. Home address. *Dirección Residencial.* _____

3. City. *Ciudad.* _____ State. *Estado.* _____ Zip. *Código Postal.* _____

4. Date of Injury. *Fecha de la lesión (accidente).* _____ Time of injury. *Hora en que ocurrió* _____ a.m. _____ p.m.

5. Address and description of where injury happened. *Dirección/lugar dónde ocurrió el accidente.* _____

6. Describe injury and part of body affected. *Describe la lesión y parte del cuerpo afectada.* _____

7. Social Security Number. *Número de Seguro Social del Empleado* _____

8. Signature of employee. *Firma del empleado.* _____

**Employer - complete this section and give the employee a copy immediately as a receipt.
 Empleador - complete esta sección y déle inmediatamente una copia al empleado como recibo.**

9. Name of employer. *Nombre del empleador.* _____

10. Address. *Dirección.* _____

11. Date employer first knew of injury. *Fecha en que el empleador supo por primera vez de la lesión o accidente.* _____

12. Date claim form was provided to employee. *Fecha en que se le entregó al empleado la petición.* _____

13. Date employer received claim form. *Fecha en que el empleado devolvió la petición al empleador.* _____

14. Name and address of insurance carrier or adjusting agency. *Nombre y dirección de la compañía de seguros o agencia administradora de seguros.* **CLAIMS MANAGEMENT SERVICE** _____

15. Insurance Policy Number. *El número de la póliza del Seguro.* _____

16. Signature of employer representative. *Firma del representante del empleador.* _____

17. Title. *Título.* _____ 18. Date. *Fecha.* _____ 19. Telephone. *Teléfono.* _____

Employer: You are required to date this form and provide copies to your insurer or claims administrator and to the employee, dependent or representative who filed the claim within **one working day** of receipt of the form from the employee.

Empleador: Se requiere que Ud. feche esta forma y que provéa copias a su compañía de seguros, administrador de reclamos, o dependiente/representante de reclamos y al empleado que hayan presentado esta petición dentro del plazo de **un día hábil** desde el momento de haber sido recibida la forma del empleado.

SIGNING THIS FORM IS NOT AN ADMISSION OF LIABILITY
 Claims Management Service is a Division of State Compensation Insurance Fund
 SCIF 4601 (NEW 2-97) - DWC Form 1 (REV. 1-94)

EL FIRMAR ESTA FORMA NO SIGNIFICA ADMISION DE RESPONSABILIDAD

CLAIMS
 MANAGEMENT
 SERVICE

COUNTY OF MONO

DECLINATION OF MEDICAL TREATMENT INSTRUCTIONS

This packet is for use ONLY if the Employee DECLINES medical treatment at time of injury.

If the Employee will go to either a physician, nearest hospital or urgent care facility the Initial Injury-Workers' Compensation Packet (DWC 1 and 5020 forms) must be completed instead of this packet.

DO NOT USE PENCIL TO COMPLETE THE PACKET.

Employee:

- Complete and sign the top portion of the ***Incident Report***.
- Complete and sign the ***Declination of Medical Treatment*** form.

Supervisor and/or Department Safety Representative:

- Review and sign the ***Declination of Medical Treatment*** form.
- Complete and sign the bottom portion of the ***Incident Report***
- Complete any applicable standard Safety procedures including, but not limited to, filing an Incident/Hazard Report Form.
- Send all completed 'original' forms to Rita Sherman, Risk Management in a confidential routing envelope within 24 hours.
- No further action is necessary at this time.

If the Employee needs or requests medical treatment in the future:

- Have the Employee and Supervisor complete an Initial Injury Packet
- Notify Rita Sherman, Risk Management immediately

COUNTY OF MONO

INCIDENT REPORT:
(Employee & Supervisor complete)

Declined Medical Treatment

This form should be completed ONLY if the Employee does not need (or request) medical treatment. If the Employee will go to either the nearest hospital, urgent care facility or physician, the Initial Injury Workers' Compensation Packet must be completed instead of the Declination of Medical Treatment Packet.

"Any person who makes or causes to be made any knowingly false or fraudulent material statement or material representation for the purpose of obtaining or denying workers compensation is guilty of a felony. This notice has been approved by the Administrative Director of the Division of Workers' Compensation (California Labor Code Section 5401.7)"

EMPLOYEE COMPLETE TOP PORTION:

EMPLOYEE NAME:		Gender: M F	<input type="checkbox"/> Full Time <input type="checkbox"/> Part time
JOB TITLE:		DATE OF HIRE:	
HOME TELEPHONE:		DATE OF BIRTH:	
HOME ADDRESS:		ENTITY:	
		DEPARTMENT:	
INCIDENT DATE:	TIME OF INCIDENT:	LOCATION:	
DATE REPORTED:	TIME BEGAN WORK:	INCIDENT REPORTED TO:	
NATURE OF INJURY (e.g., puncture, strain, cut, fracture, burn, etc.):			
BODY PART INJURED (e.g., right wrist, left knee, head, lower back, etc.):			
INJURY SOURCE (e.g., wet pavement, jack hammer, keyboard, etc.):			
HOW INJURY OCCURRED (struck by ..., fell from ..., exposed to ..., etc.):			
DESCRIBE ANY PREVIOUS CONDITIONS/INJURIES TO BODY PART CURRENTLY INJURED:			
EMPLOYEE'S STATEMENT OF WHAT OCCURRED			
<small>(Include as much detail as possible such as activity being performed, objects carried, equipment used, hazardous conditions, etc.):</small>			
WHO WITNESSED THE INCIDENT?			
<input type="checkbox"/> The above information is true and correct to the best of my knowledge. <input type="checkbox"/> I understand that I am not filing a Workers' Compensation claim at this time. I do not choose to complete the DWC Form 1 "Employee's Claim for Workers' Compensation Benefits" at this time.			
<p style="text-align: center;"><u>If I am in need of medical treatment in the future related to this incident, I will immediately inform my Supervisor and complete an Initial Injury Packet including the DWC Form 1 and 5020 form.</u></p>			
EMPLOYEE'S SIGNATURE:			DATE:

SUPERVISOR COMPLETE BOTTOM PORTION:

MEDICAL TREATMENT (NOTE: If the Employee needs/requests medical treatment from a physician, complete the Initial Injury Packet)		
<input type="checkbox"/> EMPLOYEE DECLINED MEDICAL TREATMENT <input type="checkbox"/> EMPLOYEE RECEIVED MINOR FIRST AID CARE ON-SITE. Describe:		
SUPERVISOR:		TITLE:
SIGNATURE:	DATE:	TELEPHONE:

COUNTY OF MONO

Declination of Medical Treatment

This form should be completed ONLY if the Employee **DECLINES** medical treatment. If the Employee will go to either a physician, an Urgent Care facility or nearest hospital the **Initial Injury-Workers' Compensation Packet must be** completed instead of the Declination of Medical Treatment Packet.

EMPLOYEE: Check all that apply. Print name, sign and date.

In my opinion, I am not in need of any medical treatment at this time.

OR

In my opinion, I have received sufficient on-site first aid care.

I am fully capable of performing my Usual & Customary position. At this time I decline medical care. If I am in need of medical care related to this incident in the future, I will notify my Supervisor immediately and complete an Initial Injury Packet including the DWC Form 1 "Employee's Claim for Workers' Compensation Benefits.

Print Name: _____

Signature: _____

Date: _____

SUPERVISOR: Print, sign and date.

Print Name: _____

Signature: _____

Date: _____

Note: California Labor Code Section 5401(a) defines a First Aid injury as any one-time treatment, and any follow-up visit for the purpose of observation of minor scratches, cuts, burns, splinters, or other minor industrial injury, which does not ordinarily require medical care" and states that any injury that "results in lost time beyond the employee's work shift at the time of injury or which results in medical treatment beyond first aid" must be filed as a claim. All of the treatments detailed above fall under the First Aid category; therefore, unless further treatment is necessary, a workers' compensation claim does not need to be filed.

APPENDIX F

Emergency Contact, Supervisory Structure and Minimum Qualifications

EMERGENCY NOTIFICATION LIST

Mono County Solid Waste Program

<u>Title / Responsibility</u>	<u>Name</u>	<u>Office Phone</u>	<u>Cellular Phone</u>	<u>Home Phone</u>
Solid Waste Facilities				
Benton Crossing Landfill	Office	n/a.....	(760) 937-2192.....	n/a
Site Supervisor	Tom Music	n/a.....	(760) 937-2659.....	n/a
Benton TS – Gate Attendant.....	Pauline Moran	n/a.....	(775) 258-5344.....	n/a
Bridgeport TS – Gate Attendant.....	Robert Gilman	n/a.....	(760) 920-7258.....	n/a
Chalfant TS – Gate Attendant.....	Pauline Moran	n/a.....	(760) 920-7277.....	n/a
Paradise TS – Gate Attendant.....	Shawn Scoggins.....	n/a.....	(760) 920-7277.....	n/a
Pumice Valley TS – Gate Attendant	Robert Gilman	n/a.....	(760) 920-7258.....	n/a
Walker TS – Gate Attendant.....	Mike Vaughan	n/a.....	(775) 247-6018.....	n/a
Solid Waste Administration				
Solid Waste Superintendent	Tony Dublino	(760) 932-5453.....	(760) 616-0613.....	n/a
Equipment Maintenance	Jerry VandeBrake.....	(760) 932-5462.....	(530) 208-6422.....	n/a
Public Works Administration	Megg Hawkins	(760) 932-5440.....	n/a.....	n/a
D&S Waste Removal (Contract Transfer Station Operator)				
General Manager	Darrol Brown	(775) 463-3090 / (866) 463-3090.....	(775) 277-0175.....	n/a
Supervisor	Kevin Brown.....	(775) 463-3090 / (866) 463-3090.....	(775) 277-0143.....	n/a
Transfer Station Manager	Shawn Scoggins.....	n/a.....	(760) 920-5646.....	n/a
Mono County Environmental Health Department				
LEA Program.....	Jill Kearney.....	(760) 924-1846 / (760) 932-5580.....	(530) 304-3911.....	n/a
Director.....	Louis Molina	(760) 924-1845 / (760) 932-5588.....	(760) 937-7246.....	n/a
Road Districts				
Road Operations Manager.....	Jeff Walters	(760) 932-5459.....	(775) 309-3343.....	n/a
District 1 (Crowley).....	Steve Reeves.....	(760) 935-4347.....	(760) 937-1894.....	n/a
District 2 (Benton)	Josh Rhodes	(760) 933-2311.....	(760) 937-1436.....	n/a
District 3 (Lee Vining).....	Jason Small	(760) 647-6336.....	(760) 937-1896.....	n/a
District 4.5 (Bridgeport & Walker)	Cory Gonzales	(760) 932-5288.....	(760) 920-1849.....	n/a
Walker Road Shop	(530) 495-2202.....	n/a.....	n/a
Mono County Risk Manager				
Risk Manager.....	Sarah Messerlian.....	(760) 932-5415.....	n/a

<u>Emergency Response</u>	<u>Location</u>	<u>Office Phone</u>
Sheriff's Department (911)	Bridgeport.....	(760) 932-7549
Sgt. Jeff Beard, Emergency Services	Bridgeport.....	(760) 932-7549 ext. 114
California Highway Patrol (911).....	Bridgeport.....	(760) 932-7995
.....	Bishop.....	(760) 873-3531
Fire Districts.....	911
Cal Fire – Owens Valley (office)	Bishop.....	(760) 387-2565
Cal Fire – Owens Valley (dispatch)	(909) 881-6916
BLM / USFS Fire Response (dispatch).....	Bishop.....	(760) 873-2488
Paramedics.....	911
Hospitals / Clinics		
Mammoth Emergency Room	Mammoth Lakes	(760) 934-3311 ext. 2234
Bridgeport Clinic.....	Bridgeport.....	(760) 932-7011
Northern Inyo	Bishop.....	(760) 873-5811
Carson Valley Urgent Care	Gardnerville, NV	(775) 782-1600
<u>Other Offices / Agencies</u>		
California Dept. of Transportation (Caltrans)	Bishop.....	(760) 872-0601
Eastern Sierra Oil (Diesel Fuel).....	Bishop.....	(760) 872-4645
Propane Gas Companies		
Amerigas	Bishop.....	(760) 873-6371
.....	Bridgeport.....	(760) 932-7961
.....	Mammoth Lakes	(760) 934-2213 or, 934-6333
.....	Walker.....	(530) 495-2324
Eastern Sierra Propane	Bishop.....	(760) 872-2955
Turner Propane.....	Mammoth Lakes	(760) 934-6811
.....	Bishop.....	(760) 872-1314
Waste Collection Companies		
Mammoth Disposal	Mammoth Lakes	(760) 934-2201
D&S Waste Removal	Yerington, NV	(775) 463-3090

Note: home telephone numbers are not published on the emergency contact list distributed as an attachment to permit documents.

ORGANIZATIONAL CHART MONO COUNTY SOLID WASTE OPERATIONS

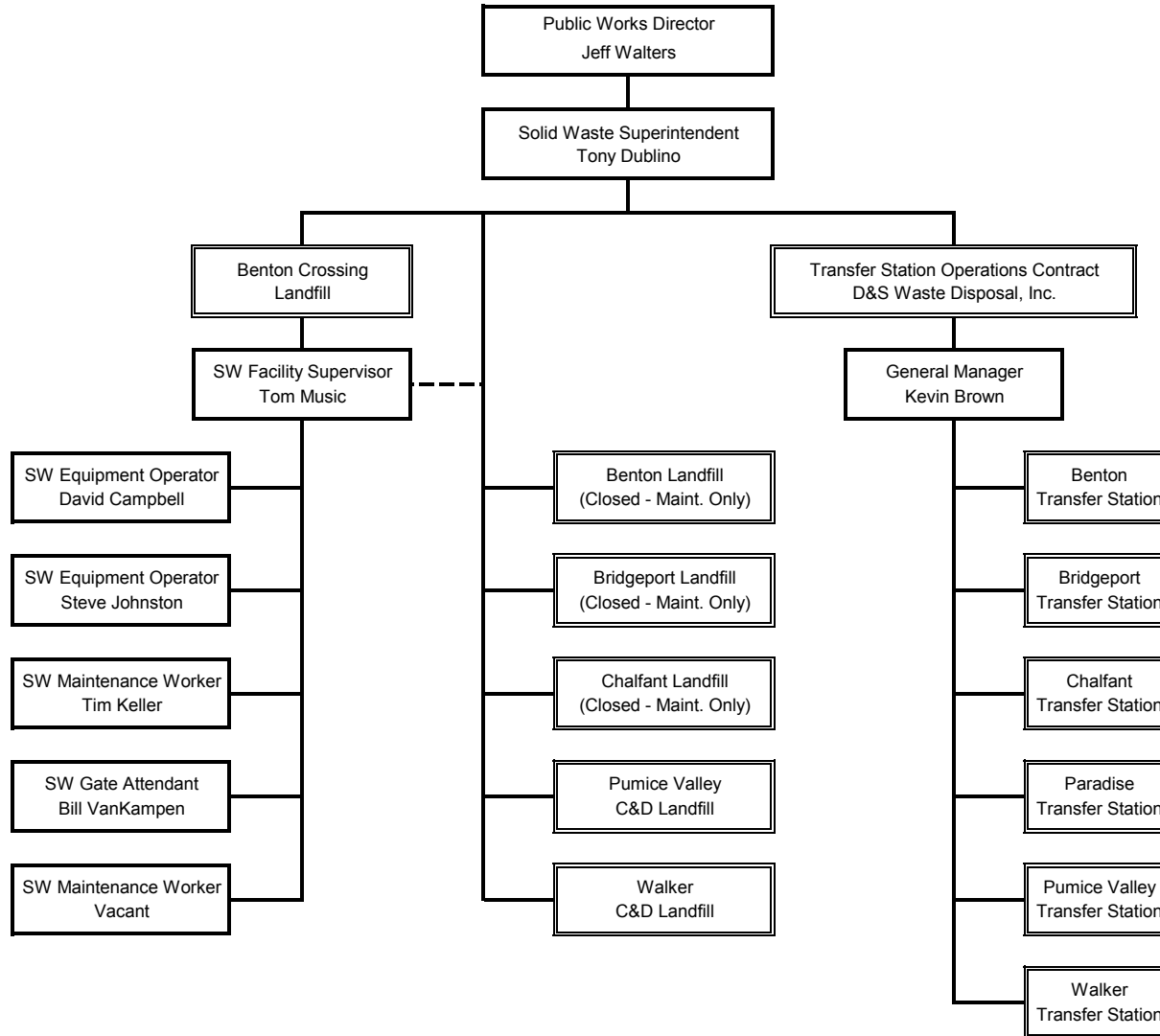

SOLID WASTE SUPERINTENDENT

DEFINITION

Under general direction, to plan, organize, manage, and coordinate the services, functions, and activities of Solid Waste Division of the Public Works Department, and to do related work as assigned.

DISTINGUISHING CHARACTERISTICS

This is a single position classification for a management position which provides direction and supervision for the County Solid Waste Facilities. Responsibilities include project development, contract administration, compliance monitoring, and staff supervision, assignment, and scheduling.

REPORTS TO

Public Works Director, Assistant Public Works Director, or designee.

CLASSIFICATIONS SUPERVISED

Solid Waste Supervisor, Solid Waste Equipment Operator, Solid Waste Maintenance Worker, Fiscal and Technical Specialist.

EXAMPLES OF IMPORTANT AND ESSENTIAL DUTIES *(The following is used as a partial description and is not restrictive as to duties required.)*

- Develops and implements short- and long-term division goals, objectives, policies and procedures; develops long-range plans for major County solid waste facility improvement and maintenance projects;
- Directs, oversees and coordinates the scheduling and performance of work by Division staff;
- Prepares the division budget and individual project budgets, identifying needs, estimated expenses, and projected funds available;
- Manages the divisional budget assuring that funded projects are completed and budgetary and legal and regulatory constraints are followed;
- Ensures compliance with regulatory requirements;
- Develops and administers the County's recycling program and household hazardous waste program;
- Compiles, maintains, and performs quality control for program data and records and prepares required reports;
- Maintains current awareness of legislation and issues regarding solid waste facility operation and permitting, recycling program operation, and hazardous waste management and disposal;
- Responds to inquiries, suggestions, and complaints from the public and County representatives;
- Develops and implements solutions to complex and sensitive situations impacting the public and ensuring the safety and quality of work;
- Meets with community groups and civic organizations to educate and discuss issues relating to solid waste facilities and the County's solid waste program;
- Ensures that safety standards are observed;

- Meets with fire, safety, and regulatory inspectors to discuss possible hazards, operational deficiencies, and corrections;
- Develops project plans and specifications for improvement projects, develops contract documents and bid packages for bidding purposes, and manages, inspects, and certifies completion of projects;
- Meets with contractors and consultants to provide and obtain information on matters involving the division;
- Provides project management for contract projects;
- Inspects, manages, and provides input to contractors working at County disposal facilities;
- Supervises, trains, and evaluates assigned staff;
- Represents the County at public meetings;
- Assigns and reviews the investigation and reporting of industrial and equipment accidents;
- Works cooperatively with Public Works' Fleet Operations Division to ensure the repair, maintenance, and procurement of equipment;
- Obtains facts, analyzes evidence, and makes decisions or takes actions to correct problems;
- Integrates new programs into existing operations;
- Prioritizes workload for prompt completion of emergency and unscheduled work requests;
- Coordinates functions of the Solid Waste Local Task Force, including meeting schedules, agendas, and minutes, and task force membership;
- Performs required environmental monitoring, including sampling and reporting, and/or manages contracts required to comply with sampling, analysis, and reporting requirements;
- Develops, maintains, monitors, and updates operating permits;
- Administers waste collection franchise agreements and manages and works cooperatively with franchise haulers and their customers;
- Administers, monitors, renews, and updates program revenue sources, including gate fees and the solid waste fee program.

TYPICAL PHYSICAL REQUIREMENTS

Sit for extended periods; frequently stand and walk; ability to walk in uneven terrain and on slippery surfaces; normal manual dexterity and eye-hand coordination; ability to crawl through various areas requiring movement on hands and knees; ability to climb, stoop, crouch, and kneel; lift and move objects weighing up to 50 lbs.; perform sustained physical work; corrected hearing and vision to normal range; verbal communication; use of office equipment, including computer, telephone, calculator, copiers, and fax; operate an automobile and two-way radio.

TYPICAL WORKING CONDITIONS

Work is performed in building and outdoor environments; work is performed in varying temperatures; exposure to dust, chemicals, and gases; continuous contact with other staff.

DESIRABLE QUALIFICATIONS

Knowledge of:

- Principles, practices and planning techniques for operation and permitting of solid waste facilities.
- Laws regulating solid waste facilities.
- Principles of personnel administration, including training, supervision, performance evaluation, and discipline.
- Budget and cost estimating principles.
- Legal and safety requirements, occupational hazards and safety standards.
- Precautions as they relate to solid waste management and operations.

- Equipment, materials, and methods used in the operations of solid waste facilities.
- Principles and practices of contract administration.
- Principles, practices, and planning techniques for public education.
- Development and administration of contracts.

Ability to:

- Work cooperatively and effectively with County personnel, contractors, consultants, and the public.
- Communicate professionally and effectively both orally and in writing.
- Provide positive, professional, and responsive customer service.
- Identify needs, recognize problems, and develop solutions regarding solid waste facilities.
- Perform inspections, identify deficiencies, and implement corrective action.
- Establish work priorities and/or make operational changes.
- Plan, organize, schedule, and direct the maintenance and repair of assigned County facilities and associated equipment and personnel.
- Provide supervision, training, and performance evaluation for assigned staff.
- Estimate time and materials requirements for maintenance and repair projects.
- Read and interpret project plans and specifications.
- Develop project scopes of work, solicit bids, and negotiate and administer contracts.
- Prepare budget recommendations and monitor expenditures within budget authorizations.
- Make mathematical calculations quickly and accurately.
- Prepare clear, concise, and accurate reports.
- Represent the County facilities functions with other County management.
- Establish and maintain cooperative working relationships.
- Lead Solid Waste Local Task Force meetings.

Training and Experience:

Any combination of training and experience which would likely provide the required knowledge and abilities is qualifying. A typical way to obtain the required knowledge and abilities would be:

Six years of increasing responsibility in solid waste management, including at least two years of supervisory experience,

AND

A bachelor's degree in civil engineering, geology, physics, chemistry, or in a similar field in the environmental or physical sciences. Alternatively, a bachelor's degree in business management with a minor or coursework in environment or physical sciences.

Special Requirements:

Possession of a driver's license valid in California.

The contents of this class specification shall not be construed to constitute any expressed or implied warranty or guarantee, nor shall it constitute a contract of employment. The County of Mono assumes no responsibility beyond the general accuracy of the document, nor does it assume responsibility for any errors or omissions in the information contained herein. The contents of this specification may be modified or revoked without notice. Terms and conditions of employment are determined through a "meet and confer" and/or individual employment contract process and are subject to the Memorandum of Understanding or employment contract currently in effect.

SOLID WASTE SUPERVISOR

DEFINITION

Under general supervision, to direct, oversee, and supervise, the operations, activities, and personnel involved in equipment operation, recycling functions, and maintenance activities at County Solid Waste facilities; and to do related work as required.

DISTINGUISHING CHARACTERISTICS

This is a full supervisory level in the Solid Waste Equipment Operator/Supervisor class series. The incumbent is responsible for supervising staff and planning and scheduling operations for the County's Solid Waste facilities. In addition, the incumbent oversees and supervises equipment operation and maintenance activities at the County's Solid Waste sites.

CLASSIFICATIONS SUPERVISED

Solid Waste Equipment Operator, Solid Waste Gate Attendant, and Solid Waste Maintenance Attendant.

EXAMPLES OF IMPORTANT AND ESSENTIAL DUTIES (The following is used as a partial description and is not restrictive as to duties required.)

Plans, organizes, and supervises operations, staff, and maintenance at County Landfill facilities; supervises, trains and evaluate the work of assigned staff; provides safety training to staff; performs transfer site inspections; deals with customer complaints regarding Landfill operations and services; participates in the development and administration of the County Recycling Program; develops and administers landfill and transfer station contracts; directs the development and develops required reports and records; maintains current awareness legislation and issues which effect hazardous materials and hazardous waste disposal; oversees equipment operation and maintenance functions at the County's Solid Waste sites and transfer stations; operates various collection vehicles and heavy equipment as needed.

TYPICAL PHYSICAL REQUIREMENTS

Sit for extended periods; frequently stand and walk; ability to walk on slippery and uneven surfaces; normal manual dexterity and eye-hand coordination; ability to crawl through various areas requiring movement on hands and knees; ability to climb, stoop, crouch, and kneel; lift and move objects weighing up to 50 lbs.; perform sustained physical work; corrected hearing and vision to normal range; verbal communication; use of office equipment, including computer, telephone, calculator, copiers, and FAX; use hand tools and power equipment.

SOLID WASTE SUPERVISOR - 2

TYPICAL WORKING CONDITIONS

Work is performed in a building and outdoor environment; work is performed in varying temperatures; exposure to grease, solvents, chemicals, and pesticides; continuous contact with other staff and the public.

DESIRABLE QUALIFICATIONS

Knowledge of:

Basic knowledge of laws, rules, regulations, and policies affecting solid waste operations and facility development.

Principles and practices of solid waste management control.

Operation and maintenance of a solid waste sites and transfer facilities.

Operation and maintenance requirements of collection/transfer vehicles and heavy equipment, including state and federal inspections programs.

Safety work practices and regulations,

Computers and software used in solid waste management and administrative work.

Principles of staff supervision, employee training, and work evaluation.

Ability to:

Plan, organize, supervise, and coordinate County Landfill site operation, equipment operations, and maintenance functions.

Provide supervision, training, and work evaluation for assigned staff.

Assist with studies and project development for Landfill facilities operations, maintenance, and site improvement.

Read and interpret laws, ordinances, regulations, and guidelines related to solid waste services and facility operations and maintenance.

Operate a computer and use appropriate software in the performance of solid waste administrative work.

Effectively represent the Public Works Department and the Solid Waste Program in responding to inquires, providing assistance, and dealing with public.

Establish and maintain cooperative working relationships.

Training and Experience:

Any combination of training and experience which would likely provide the required knowledge and abilities is qualifying. A typical way to obtain the required knowledge and abilities would be:

Five (5) years of increasingly responsible work experience in solid waste equipment operation, site maintenance, and site operations. Previous lead/supervisory experience is highly desirable.

SOLID WASTE SUPERVISOR - 3

DESIRABLE QUALIFICATIONS (continued)

Special Requirements:

Possession of, or ability to obtain, a valid, current, and appropriate class of California Driver=s License required to perform the majority of regular job assignments.

Some job assignments may require a special Class of California Driver's license and endorsements.

The contents of this class specification shall not be construed to constitute any expressed or implied warranty or guarantee, nor shall it constitute a contract of employment. The County of Mono assumes no responsibility beyond the general accuracy of the document, nor does it assume responsibility for any errors or omissions in the information contained herein. The contents of this specification may be modified or revoked without notice. Terms and conditions of employment are determined through a "meet and confer" process and are subject to the Memorandum of Understanding or "At-Will" Contract currently in effect.

SOLID WASTE EQUIPMENT OPERATOR

DEFINITION

Under direction, to perform the full range of assignments and duties involved in the maintenance, repair, and construction of roads, landfill waste cells and cover systems, drainage systems, and other structures at County solid waste facilities; to operate, maintain, and perform general repairs of all tools and equipment; to monitor and inspect incoming waste loads; to control and direct traffic; to maintain storage and stockpile areas; to perform routine grounds maintenance duties of County solid waste facilities; to explain and enforce rules, regulations, policies, and procedures in a tactful and courteous manner; and to perform other job related work as required.

DISTINGUISHING CHARACTERISTICS

This is the advanced journey level in the Solid Waste Worker Class series. Incumbents in this series will be assigned primarily to landfill work, but may be cross-trained in and assigned to waste transfer operations or Road Division or Facilities Division work within the Department of Public Works. Incumbents perform the full range of tasks with minimal supervision. Incumbents may also provide lead direction and training to subordinate staff.

REPORTS TO

Site Supervisor or Operations Manager.

CLASSIFICATIONS DIRECTLY SUPERVISED

May provide lead direction and training to gate attendants and laborers.

EXAMPLES OF DUTIES

Duties may include, but are not limited to, the following:

Perform duties specified in written operating procedures established for County solid waste facilities and apply rules and regulations developed for such facilities.

Perform the full range of duties in the maintenance, construction, and repair of on-site roads, landfill cover, drainage systems, and other systems at County solid waste facilities.

Operate a variety of heavy construction and landfill disposal equipment, including bulldozers, landfill compactors, scrapers, wheel loaders, backhoes, skid steer loaders, motor graders, dump trucks, water trucks, and tilt-frame trucks.

Operate a variety of smaller equipment, including generators, stationary compactors, steam cleaners, forklifts, welding equipment, cutting torches, air compressors, pumps, hand tools, and power tools.

Push and compact solid waste; excavate, haul, place, and compact soil to cover solid waste; and, maintain daily, intermediate, and final cover.

Routinely monitor and inspect incoming waste loads for prohibited material and remove and properly store such materials.

Assist with the operation and maintenance of facility stockpiles and storage areas.

Perform scalehouse operation duties in accordance with the specifications of the job description for the Solid Waste Gate Attendant worker class, as necessary.

Perform laborer duties in accordance with the specifications of the job description for the Solid Waste Maintenance Attendant worker class, as necessary.

Assist in the performance of routine grounds maintenance tasks.

Assist with minor construction and repair of site facilities.

Maintain traffic control and assist with the installation, maintenance, and repair of traffic control devices and warning signs as required.

Assist with the installation, maintenance, and repair of litter control devices as required.

Assist with placement of synthetic tarps or other mechanisms used as alternative daily cover over the active working face of the landfill.

Perform random physical load inspections, record findings, handle hazardous and other prohibited waste detected in the load in accordance with the County's Load Checking Program.

May drive vehicles to transport materials, tools, and equipment.

Operate, clean, and care for hand tools and equipment.

Perform general maintenance, adjustments, and repair tasks on landfill equipment and tools, including assisting mechanics with routine preventative maintenance programs.

Assist with inspections of site facilities and reports on deficiencies.

Perform emergency response measures according to established procedures in the event of fire or other emergency conditions.

Perform related duties as assigned.

TYPICAL PHYSICAL REQUIREMENTS

Sit for extended periods; frequently stand, walk, stoop, kneel, and crouch; physical ability to lift and carry objects weighing up to 50 pounds unassisted and greater than 50 pounds with assistance; normal manual dexterity and hand-eye coordination; corrected hearing and vision to normal range; verbal communication; use of equipment including hand and power tools, hydraulic equipment, computers, printers, and telephones.

TYPICAL WORKING CONDITIONS

Work is performed outdoors in varying temperature, severe weather, and humidity condition; work is performed in environment with constant noise; exposure to fumes, dust, grease, and oils; exposure to moving equipment; exposure to electrical current; exposure to controlled and hazardous substances, pesticides, herbicides, paints, and chemicals; frequent contact with staff and the public. Incumbents are subject to working after hours, evenings, weekends, holidays, and call-outs.

DESIRABLE QUALIFICATIONS

Knowledge of:

- Operation of maintenance and construction tools and equipment.
- Materials, methods, practices, and equipment used in the construction, maintenance, and repair of roads, drainage systems, landfill waste cells and cover systems, and other features used in the proper operation of solid waste facilities.
- Vehicle classifications, capabilities, and capacities.
- Methods and practices followed in the maintenance, care, repair, and minor adjustments of tools, machinery, and equipment.
- Snow removal methods, procedures, and equipment.
- Traffic laws, rules, and ordinances involved in truck and heavy equipment operations; traffic control practices and regulations.
- Principles of lead direction and training.
- General clerical procedures, including cash transactions and basic record-keeping.
- Basic arithmetic.
- Occupational hazards and safe work practices.

Ability and willingness to:

- Learn, interpret, understand, and apply pertinent laws, codes, regulations, policies, and procedures.
- Explain and enforce rules, regulations, policies, and procedures in a tactful and courteous manner.
- Follow established safe work rules, practices, policies, and procedures.
- Perform a variety of unskilled and semi-skilled tasks in the maintenance and operation of County landfills and transfer stations.
- Perform heavy physical labor.
- Operate all required equipment, tools, and vehicles.
- Clean, maintain, and make basic repairs to equipment and tools.
- Recognize and identify conditions that require maintenance and repair work.
- Identify hazardous wastes and apply established procedures for their proper handling.
- Identify recyclable and salvageable materials and apply established procedures for their proper handling.
- Collect and count money, make change and issue receipts, use a cash box or register.
- Reconcile cash against receipts and prepare bank deposits.
- Perform required mathematical computations with accuracy.

- Prepare and maintain accurate and complete records and reports in a legible manner and according to prescribed procedures.
- Communicate clearly and concisely, both orally and in writing.
- Establish and maintain cooperative working relationships.
- Understand and accurately follow oral and written directions.
- Work effectively in the absence of supervision.
- Work effectively in emergency and stressful situations.
- Maintain confidentiality.

Training and Experience:

Any combination of training and experience that would provide the required knowledge and abilities is qualifying. A typical way to obtain the knowledge and abilities would be:

Two years of increasingly responsible work experience in road, landfill, or other earth-moving construction and maintenance work, including at least one year operating heavy power-driven construction equipment such as bulldozers, landfill compactors, scrapers, wheel loaders, and/or dump trucks; experience in performing teller or cashier activities; experience or training in entrance gate or retail store operation.

Special Requirements:

High school diploma or GED equivalent

Possession of a valid California driver's license. Possession of a Class A California driver's license, or the ability to obtain a Class A license within six months of hire date, may be required depending on assignment.

Salary Range: 54

This job specification should not be construed to imply that these requirements are the exclusive standards of the position. Not all duties are necessarily performed by each incumbent. Additionally, incumbents will be required to follow instructions and to perform other job related duties as may be required.

SOLID WASTE MAINTENANCE WORKER

DEFINITION

Under supervision, to perform a variety of assignments and duties involved in the operation of County solid waste facilities; to monitor and inspect incoming waste loads; to control entrance facilities; to control and direct traffic; to operate, maintain, and perform minor repairs to and maintenance of assigned tools and equipment; to maintain storage and stockpile areas; to operate wood chipper, wheel loader, forklift, and other equipment necessary for the management of wastes requiring special handling; to identify, classify, and manage hazardous and universal wastes; to assist in the application of alternative daily cover; to prepare and maintain routine records of solid waste disposal activities; to perform routine grounds maintenance duties at County solid waste facilities; to explain and enforce rules, regulations, policies, and procedures in a tactful and courteous manner; and, to perform other job related work as required.

DISTINGUISHING CHARACTERISTICS

Incumbents in this classification are responsible for the assessment and collection of gate fees and for the operation of weigh scales. They must also have the ability to control the waste stream as it enters the facility, direct traffic within the facility, and to communicate with the public in a friendly, tactful, and courteous manner. Incumbents maintain records, control litter, and perform routine daily operation and maintenance of the equipment, stockpiles, and structures located at their assigned solid waste site(s).

REPORTS TO

Site Supervisor or Operations Manager.

CLASSIFICATIONS DIRECTLY SUPERVISED

None.

EXAMPLES OF DUTIES

Duties may include, but are not limited to, the following:

Scalehouse Operation:

Prepare entrance area for business each day.

Provide accurate information to the public related to facility operations and the County's solid waste program in a prompt, courteous, and tactful manner.

Ask customers questions related to load content and origin; check each load for hazardous and other prohibited waste and handle any such waste in accordance with the County's Load Checking Program.

Assess each load as to type and weight or volume of solid waste material, calculate fees, perform cash and account transactions, and complete written receipts.

Maintain security of cash and receipts, reconcile cash and account records against receipts and prepare deposits.

Operate a weigh scale and/or large trash compactors in conformance with applicable state and local regulations and manufacturer's guidelines.

Prepare and maintain routine records of solid waste disposal activities.

Receive, record, and respond to inquiries and complaints from customers and the general public.

Maintenance Tasks:

Perform daily litter control and routine grounds maintenance tasks.

Assist with minor construction and repair of site facilities.

Install, maintain, and repair traffic control devices and warning signs as directed.

Install, maintain, and repair litter control devices as directed.

Remove and properly dispose of litter and windblown debris throughout the facility and around site perimeters, including areas extending beyond property boundaries.

Assist with placement of synthetic tarps or other mechanisms used as alternative daily cover over the active working face of the landfill.

Remove salvageable material from working face(s) and relocate to appropriate stockpile.

Provide routine cleaning and maintenance of the weigh scale and/or trash compactors, including snow removal.

Operate, clean, and care for hand tools and equipment.

Perform routine maintenance and repair tasks on equipment.

Both Functions:

Perform duties specified in written operating procedures established for County solid waste facilities and apply rules and regulations developed for such facilities.

Unlock and open the entrance gate at the beginning of each operating day.

Close and lock the entrance gate at the end of each operating day.

Control the flow of traffic entering, exiting, and operating within the facility.

Provide instruction and direct customers to the appropriate unloading area(s).

Operate and maintain facility stockpiles and storage areas, including tires, appliances, scrap metal, wood, recyclables, used motor oil, hazardous wastes, universal wastes, and other items as directed.

Operate equipment necessary for the management and maintenance of stockpiles and wastes requiring special handling, including tires, appliances, scrap metal, wood, recyclables, used motor oil, and hazardous and universal wastes.

May be required to drive vehicles to transport materials or to operate construction equipment, such as loaders or backhoes.

Travel to County disposal sites to collect, transport, and manage wastes requiring special handling.

Inspect incoming loads and remove and manage salvageable or prohibited items as directed.

Identify, classify, store, consolidate, and manage hazardous wastes and universal wastes.

Perform random physical load inspections, record findings, handle hazardous and other prohibited waste detected in the load in accordance with the County's Load Checking Program.

Assist with inspections of site facilities and reports on deficiencies.

Report on status of supplies.

Perform emergency response measures according to established procedures in the event of fire or other emergency conditions.

Perform related duties as assigned.

TYPICAL PHYSICAL REQUIREMENTS

Sit for extended periods; frequently stand, walk, stoop, kneel, and crouch; physical ability to lift and carry objects weighing up to 50 pounds unassisted and greater than 50 pounds with assistance; normal manual dexterity and hand-eye coordination; corrected hearing and vision to normal range; verbal communication; use of equipment including hand and power tools, hydraulic equipment, computers, printers, and telephones.

TYPICAL WORKING CONDITIONS

Work is performed outdoors in varying temperature, severe weather, and humidity condition; work is performed in environment with constant noise; exposure to fumes, dust, grease, and oils; exposure to moving equipment; exposure to electrical current; exposure to controlled and hazardous substances, pesticides, herbicides, paints, and chemicals; frequent contact with staff and the public. Incumbents are subject to working after hours, evenings, weekends, holidays, and call-outs.

DESIRABLE QUALIFICATIONS

Knowledge of:

- General clerical procedures, including handling cash transactions and basic record-keeping.
- Vehicle classifications and load capacities.
- Basic arithmetic.
- Occupational hazards and safe work practices.

Ability and willingness to:

- Learn, interpret, understand, and apply pertinent laws, codes, regulations, policies, and procedures.
- Explain and enforce rules, regulations, policies, and procedures in a tactful and courteous manner.
- Follow established safe work rules, practices, policies, and procedures.
- Perform a variety of unskilled and semi-skilled tasks in the maintenance and operation of County landfills and transfer stations.

- Perform heavy physical labor.
- Operate all required equipment, tools, and vehicles.
- Clean, maintain, and make basic repairs to equipment and tools.
- Recognize and locate conditions that require maintenance and repair work.
- Identify hazardous wastes and apply established procedures for their proper handling.
- Identify recyclable and salvageable materials and apply established procedures for their proper handling.
- Collect and count money, make change and issue receipts, use a cash box or register.
- Reconcile cash against receipts and prepare bank deposits.
- Perform required mathematical computations with accuracy.
- Prepare and maintain accurate and complete records and reports in a legible manner and according to prescribed procedures.
- Communicate clearly and concisely, both orally and in writing.
- Establish and maintain cooperative working relationships.
- Understand and accurately follow oral and written directions.
- Work effectively in the absence of supervision.
- Maintain confidentiality.

Training and Experience:

Any combination of training and experience that would provide the required knowledge and abilities is qualifying. A typical way to obtain the knowledge and abilities would be:

Prior experience as a landfill gate attendant or one year of experience operating light equipment such as forklifts or backhoes or two years' experience in retail sales performing teller or cashier activities.

Special Requirements:

High school diploma or GED equivalent.

Possession of a valid California driver's license.

Ability to obtain certification in a 40-hour HAZWOPER training course within 12 months of hire and maintain that certification with annual refresher training.

Salary Range: 52

<p>This job specification should not be construed to imply that these requirements are the exclusive standards of the position. Not all duties are necessarily performed by each incumbent. Additionally, incumbents will be required to follow instructions and to perform other job related duties as may be required.</p>
--

APPENDIX G

Traffic Volume Data

Walker Landfill Traffic Volume Jan 2008-Dec 2012

(based on total gate receipts during period)

	PEAK DAY	DAILY AVG	Total
2008	(12 operating days per month)		
Jan	7	2	25
Feb	9	3	31
Mar	16	9	104
Apr	16	9	112
May	23	11	133
June	13	9	110
July	22	11	137
Aug	18	11	130
Sep	17	12	146
Oct	16	11	128
Nov	18	9	104
Dec	12	3	37

2009			
Jan	19	4	45
Feb	8	3	35
Mar	15	6	74
Apr	14	9	113
May	17	10	119
June	18	14	168
July	22	12	145
Aug	26	12	149
Sep	9	6	71
Oct	21	13	160
Nov	11	7	80
Dec	5	2	20

2010			
Jan	9	5	56
Feb	14	4	53
Mar	10	4	52
Apr	16	8	90
May	20	12	140
June	18	13	154
July	19	12	146
Aug	24	14	171
Sep	15	10	124
Oct	16	9	107
Nov	11	5	59
Dec	13	2	27

	PEAK DAY	DAILY AVG	Total
2011			
Jan	9	5	56
Feb	14	4	53
Mar	10	4	52
Apr	13	8	100
May	19	9	104
		(8 operating days per month)	
June	20	20	160
July	15	12	92
Aug	10	8	67
Sep	20	8	60
Oct	14	12	92
Dec	13	6	47

2012			
Jan	10	4	32
Feb	8	5	39
Mar	7	5	36
Apr	13	8	63
May	16	11	91
June	21	13	106
July	13	9	69
Aug	15	12	95
Sep	14	9	73
Oct	15	9	68
Dec	8	3	20

5-year Average			
Jan	11	4	43
Feb	11	4	42
Mar	12	6	64
Apr	14	8	96
May	19	11	117
June	18	14	140
July	18	11	118
Aug	19	12	122
Sep	15	9	95
Oct	16	11	111
Nov	12	7	73
Dec	10	3	30

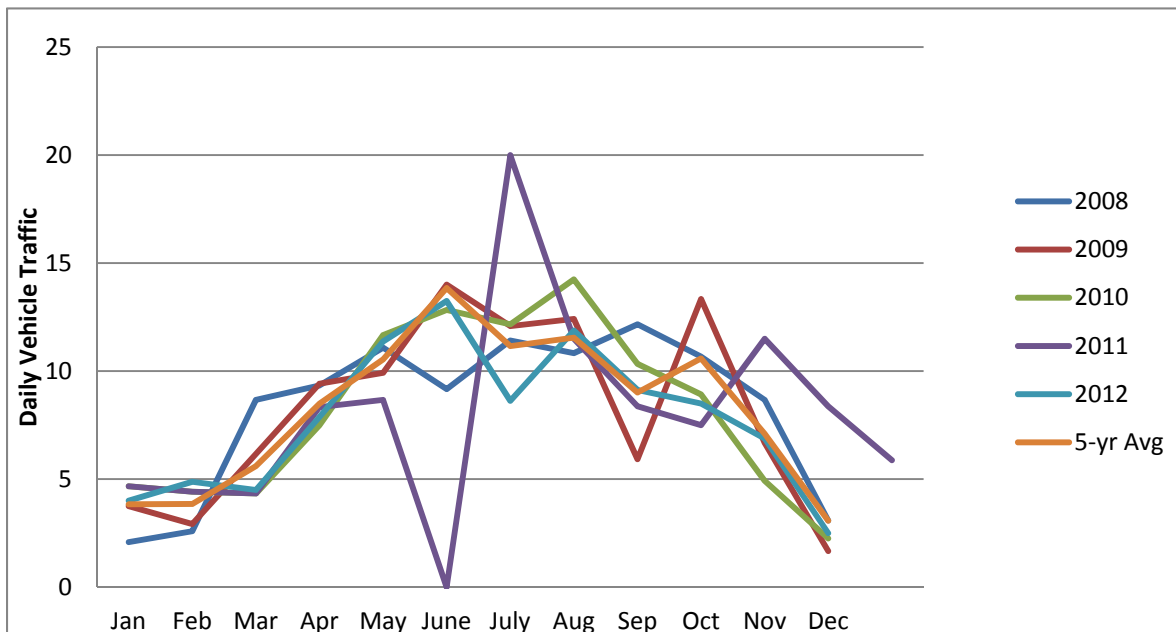
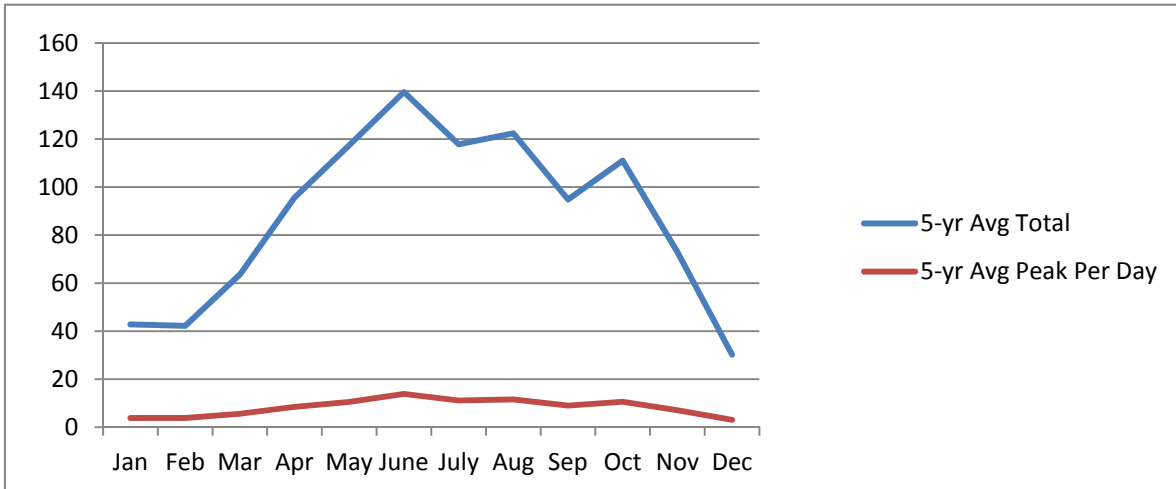

Walker Landfill
Traffic Volume 2008-2012

APPENDIX H

WDR



California Regional Water Quality Control Board



Linda S. Adams
Secretary for
Environmental Protection

Lahontan Region

Arnold Schwarzenegger
Governor

2501 Lake Tahoe Boulevard, South Lake Tahoe, California 96150
(530) 542-5400 • Fax (530) 544-2271
<http://www.waterboards.ca.gov/lahontan>



June 22, 2010

TO ALL INTERESTED PERSONS AND AGENCIES:

ADOPTED REVISED WASTE DISCHARGE REQUIREMENTS FOR WALKER CLASS III LANDFILL, MONO COUNTY

Enclosed is a copy of Board Order No. R6T-2010-0025 that was adopted at the Regional Board meeting held on Kings Beach, California.

Carrie Hackler
Office Technician

Enclosure

California Environmental Protection Agency

Recycled Paper



**CALIFORNIA REGIONAL WATER QUALITY CONTROL BOARD
LAHONTAN REGION**

**BOARD ORDER NO. R6T-2010-0025
WDID NO. 6A260012000**

**REVISED WASTE DISCHARGE REQUIREMENTS
FOR**

**MONO COUNTY DEPARTMENT OF PUBLIC WORKS
WALKER CLASS III LANDFILL**

Mono County

The California Regional Water Quality Control Board, Lahontan Region (Water Board) finds:

1. Discharger

For the purpose of this Water Board Order (Order), the County of Mono is referred to as the "Discharger."

2. Landfill

For the purposes of this Order, the Walker Class III Landfill is referred to as the "Landfill." The Landfill is a municipal solid waste landfill which was established in 1972.

3. Order History

<u>Board Order No.</u>	<u>Date Adopted</u>	<u>Description</u>
6-72-60	Feb. 7, 1972	Adopted Waste Discharge Requirements (WDRs) for the Landfill.
6-88-25	Mar. 11, 1988	Amended the WDRs to reclassify the waste management units pursuant to the amended Subchapter 15 regulations adopted on November 27, 1984 (Chapter 3, Title 23, California Administrative Code, and to reflect current Water Board policy.
6-93-100-11	Sept. 9, 1993	Amended the WDRs to incorporate the requirements of Title 40, Code of Federal Regulations (40 CFR), parts 257 and 258

(Subtitle D) as implemented in California under State Water Resources Control Board (State Water Board) Resolution No. 93-62.

6-88-25A1	Sept. 14, 1995	Amended the time schedule of Board Order No. 6-88-25.
6-96-13	Feb. 8 1996	Revised WDRs as part of a periodic review to achieve compliance with California Code of Regulation, Title 27 (27 CCR) requirements.

4. Reason for Action

The Water Board is revising these WDRs to reflect the change in use of the Landfill. The Landfill quit accepting municipal waste in 1998 and currently is used as a transfer station and disposal site for construction and demolition waste. This Order will remain in effect until it is determined there are no water quality problems or threat to water quality, or until new regulatory requirements are issued.

5. Landfill Location and Landowner

The Landfill is located on a 43.565-acre parcel, Lot 3, SW ¼, NE ¼, section 9, T8N, R23E, MDB&M (latitude 38° 33'16 N and longitude 119°27' W) as shown on Attachments A and B, which are made part of this order. The Landfill is located at 280 Offal Road, off Eastside Lane, approximately 3.5 miles north of the community of Walker off its junction with U. S. Highway 395. The Discharger is the owner of the land upon which the landfill is located.

6. Description of the Landfill

The Landfill is an unlined landfill established in 1972. From 1972 to 1998, the Landfill received municipal solid waste from Walker and adjacent communities. Prior to 1982, the Walker Landfill accepted septage waste from local residences and campgrounds. The septage pits were closed in January 1982. Since 1998, the Discharger used the Landfill as a transfer station and confined onsite disposal to construction and demolition waste. The Landfill is unlined and its waste footprint covers an area of approximately 7.6 acres.

7. Waste Classification

The Landfill received municipal solid waste from Walker and surrounding communities. The waste is defined in 27 CCR sections 20220 and 20230 as non-hazardous solid waste and inert waste, respectively.

8. Waste Management Unit Classification

Pursuant to 27 CCR section 20260, the Landfill is classified as a Class III waste management unit. The waste is defined as municipal solid waste in Subtitle D.

9. Water Quality Protection Standard

The Water Quality Protection Standard consists of constituents of concern (including monitoring parameters), concentration limits, monitoring points, and the point of compliance. The standard applies over the active life of the Landfill, closure and post-closure maintenance period, and during any compliance period. The constituents of concern, monitoring points, and point of compliance are described in Monitoring and Reporting Program (MRP) R6T-2010-0025, which is attached to and made part of this Order.

10. Data Analysis Methods

A data analysis method of reviewing the collected monitoring data is necessary for the earliest possible detection of measurably significant evidence of a release of waste from the Landfill. MRP R6T-2010-PROPOSED includes general methods for statistical data analyses in accordance with 27 CCR section 20420.

11. Detection Monitoring

Pursuant to 27 CCR section 20420, the Discharger implemented a Detection Monitoring Program (DMP), which detected a release from the Landfill in 1997. In response to this release, the Discharger implemented an Evaluation Monitoring Program (EMP) to evaluate the extent of the impacts to groundwater quality. To determine if there are additional releases from the Landfill, the DMP will continue at any groundwater monitoring points that do not show evidence of a release while the Landfill is under an EMP or a Corrective Action Program. A DMP will be re-established at all monitoring points, pursuant to 27 CCR section 20420, when groundwater impacts are abated.

12. Evaluation Monitoring

The DMP verified a release of low concentrations of volatile organic compounds (VOCs) from the Landfill in 1997. Pursuant to 27 CCR section 20425, an EMP is required to evaluate evidence of a release. The Discharger prepared and implemented an EMP in March 1997. The EMP will continue in accordance with the MRP R6T-2010-0025.

13. Corrective Action

A Corrective Action Program (CAP) to remediate detected releases from the Landfill may be required pursuant to 27 CCR section 20430 if results of the EMP warrant a CAP.

14. Site Geology

The Landfill is situated in a crescent shaped bowl that sits just above the western base of the Wellington Hills, which slopes gently down to the southwestern edge of the Antelope Valley. The sediments beneath the Landfill generally consist of coarse-grained, well indurated intrusive rock.

15. Site Hydrogeology

The groundwater beneath the Landfill is found in unconsolidated sandy gravels and silty sands with varying amounts of gravel and cobbles ranging in depth from approximately 126 to 170 feet below ground surface. Groundwater beneath the Landfill flows southwest at a gradient of 0.036 feet per foot.

16. Groundwater Monitoring

Since 1997, the monitoring network has consisted of two downgradient wells, MW-1 and MW-3, and one upgradient well, MW-2. These wells have been used for the DMP and EMP.

17. Groundwater Impacts

Since the EMP began in March 1997, MW-1 through MW-3 have been sampled quarterly for five indicator parameters (pH, total dissolved solids [TDS], chloride, nitrate as nitrogen, and sulfate) and the VOCs listed in 40 CFR Part 258, Appendix II. The EMP results show that downgradient wells have an increasing trend for three of the five indicator parameters and contain low concentrations of four VOCs. The EMP indicates that the Landfill is impacting groundwater quality and that some of the constituents (TDS, nitrates, and trichlorofluoromethane [Freon-11]) appear to be slowly increasing over time.

This Order and the Final Closure/Post-Closure Plan include measures that are designed to remediate these impacts. The closure design will collect and control run-off and will decrease infiltration into the waste and will reduce or eliminate the impacts to groundwater. If the groundwater impacts are not remediated by this measure, additional actions may be necessary to maintain groundwater water quality pursuant to State Board Resolution No. 68-16.

18. Site Surface Hydrology and Storm Water Runoff

There is no perennial surface water flow at the site. The nearest surface water body is the West Walker River, which flows through the Antelope Valley approximately two miles west and downgradient of the Landfill. There is an irrigation ditch one half mile south of the Landfill. No springs or seeps were found within a radius of one mile from the Landfill.

All storm water up-gradient of the Landfill is to be routed around at the Landfill. All storm water from the Landfill is to be regulated under the State Amended General Industrial Activities Storm Water National Pollution Discharge Elimination System Permit (NPDES). The Landfill is not located in a flood hazard zone.

The Final Closure/Post-Closure Plan includes designs for storm water structures that will divert storm water run-on around the Landfill and will collect and control internal runoff on the Landfill's surface.

19. Site Topography

The highest portion of the landfill is at approximately 5,600 feet above mean sea level (msl). The toe of the landfill is approximately 5,500 feet above msl. The land surface generally slopes to the west towards the West Walker River, which is approximately 5,300 feet above msl. Site topography is shown on Attachment B.

20. Climate

The climate is semi-arid with an average annual precipitation of 8.56 inches and an annual pan evaporation of 69 inches. Climate records show that the average annual maximum temperature for Walker is 90.7° F in July and the average annual minimum temperature is 18.6° F in December and January. Most precipitation (70 percent) falls as snow during the winter months (typically November through March), but occasional summer convection storms can bring brief but heavy rains.

21. Land Uses

The Discharger owns the 43.565-acre parcel that contains the Landfill. The land use surrounding the Landfill consists of open space within 1,000 feet of the Landfill. The community of Walker is located approximately 3.5 miles south of the Landfill.

22. Closure and Post-Closure Maintenance

The Final Closure/Post-Closure Plan proposes in-place closure of the waste and an extended period of site monitoring. Because of the lack of low-permeability soils in the vicinity of the Landfill, the Final Closure/Post-Closure Plan proposes a cover design that incorporates a geosynthetic clay liner. The Final Closure/Post-Closure Plan for the Landfill proposes an alternative cover system to the prescriptive standard of 27 CCR section 20190. The final cover will consist of the following, from lowest to highest:

- foundation soil layer with a minimum thickness of 24 inches,
- geosynthetic clay liner,
- geotextile drainage layer,
- layer of compacted native soil with a minimum thickness of 18 inches,
- top cover to be seeded or hydroseeded for erosion protection.

The cover will be installed in accordance with 27 CCR section 20324. The monitoring media include ambient air, vadose zone gases, groundwater, final cover materials, and drainage structures.

This Order recognizes that the regulations cited in the Final Closure/Post-Closure Plan are outdated and are required to be updated to reflect Title 27 regulations. This Order requires that the Discharger review the plan annually to determine if significant changes in the operation of the Landfill warrant an update of the plan.

23. Financial Assurance

The Discharger is required to obtain and maintain Financial Assurance Instruments to conduct closure activities, post-closure maintenance activities, and corrective action activities as required under 27 CCR, Chapter 6.

The Discharger has established special revenue accounts in its Solid Waste Enterprise Fund to deposit annual closure funds for each of its landfills consistent with 27 CCR section 22241. Documentation for the financial assurance is included in the Final Closure/Post-Closure Plan. Currently, the fund contains \$131,209 for closure costs at the Landfill. Furthermore, the Discharger has a Pledge of Revenue fund agreement with the Department of Resources Recycling and Recovery (CalRecycle), formerly the Integrated Waste Management Board, for post-closure maintenance in accordance with 27 CCR section 22245.

The funds do not include financial resources to conduct corrective action activities. This Order requires the Discharger to: (a) report the amount of money available in the fund as part of an annual report; (b) demonstrate in an annual report that the amount of financial assurance is adequate, or increase the amount of financial

assurance; and (c) obtain and maintain Instruments to conduct corrective action activities as required under 27 CCR, Article 1, Subchapter 3, Chapter 3 (section 20380 et seq.).

24. Receiving Waters

The receiving waters are the groundwaters of the Little Antelope Valley Groundwater Basin (Department of Water Resources [DWR] Basin No. 6-106). The DWR Bulletin No. 118, *California's Groundwater*, updated October 2003, found no evidence of water quality problems or impairments in this basin.

25. Lahontan Basin Plan

The Water Board adopted a Water Quality Control Plan for the Lahontan Basin (Basin Plan), which became effective on March 31, 1995. This Order implements the Basin Plan, as amended.

26. Beneficial Uses of Groundwater

The present beneficial uses of the groundwater of the Antelope Valley Groundwater Valley Basin are defined in the Basin Plan as:

- a. municipal and domestic supply (MUN);
- b. agricultural supply (AGR);
- c. freshwater replenishment (FRSH).

27. Storm Water Discharges

The Discharger must comply with the federal Clean Water Act, National Pollutant Discharge Elimination System (NPDES) permit requirements for discharges of storm water associated with industrial activities (State Water Board's General Permit for Discharges of Storm Water Associated With Industrial Activities) and construction activities (State Water Board's NPDES General Permit for Discharges Associated With Construction Activities).

28. Other Considerations and Requirements for Discharge

Pursuant to California Water Code section 13241, the requirements of this Order take into consideration:

- a. Past, present, and probable future beneficial uses of water:
This Order identifies past, present and probable future beneficial uses of water as described in Finding No. 26. The discharge will not adversely affect present or probable future beneficial uses of water, including municipal and domestic

water supply, agricultural supply, and freshwater replenishment.

- b. Environmental characteristics of the hydrographic unit under consideration, including the quality of water available thereto: Finding Nos. 14, 15, 17 and 24 describe the environmental characteristics and quality of water from this hydrographic unit.
- c. Water quality conditions that could reasonably be achieved through the coordinated control of all factors that affect water quality in the area:
The requirements of this Order will result in improved groundwater quality.
- d. Economic considerations:
This Order authorizes the Discharger to implement closure and post-closure maintenance actions at the Landfill as proposed by the Discharger. The Order accepts the Discharger's proposed actions as meeting the best practicable control method for protecting groundwater quality from impacts from the Landfill.
- e. The need for developing housing within the region:
The Discharger is not responsible for developing housing within the region. This Order provides WDRs for the Landfill.
- f. The need to develop and use recycled water:
There is currently no source of recycled water available to the Discharger. Additionally, the water requirements for Landfill maintenance are minimal.

29. California Environmental Quality Act

The action to revise WDRs for this Landfill involves only the change of status for the Landfill and is, therefore, exempt from the provisions of the California Environmental Quality Act (CEQA) (Public Resources Code section 21000 et seq.) in accordance with section 15301 of the CEQA Guidelines, which applies because the change of status for the Walker Landfill does not involve any expansion of use.

30. Electronic Submittal of Information

Pursuant to CCR title 23, section 3890, the Applicant shall submit reports, including soil, vapor and water data, prepared for the purpose of subsurface investigation or remediation of a discharge of waste to land subject to Division 2 of Title 27 electronically over the internet to the State Water Resources Control Board's Geotracker system. This requirement is in addition to, and not superseded by, any other applicable reporting requirement.

31. Notification of Interested Parties

The Water Board has notified the Discharger and all known interested agencies and persons of its intent to adopt revised WDRs for the project.

32. Consideration of Interested Parties

The Water Board, in a public meeting held on June 9, 2010, heard and considered all comments pertaining to the discharge.

IT IS HEREBY ORDERED that the Discharger shall comply with the following:

I. DISCHARGE SPECIFICATIONS

A. Receiving Water Limitations

Discharges from the Landfill shall not cause a violation of any applicable water quality standard for receiving water adopted by the Water Board or the State Water Board as required by the Federal Water Pollution Control Act, the California Water Code and regulations adopted thereafter. The discharge shall not cause the presence of the following substances or conditions in groundwaters of the Antelope Valley Groundwater Basin:

1. Nondegradation – State Water Board Resolution No. 68-16 “Statement of Policy With Respect to Maintaining High Quality of Waters In California,” known as the Nondegradation Objective, requires maintenance of existing high quality in surface waters, groundwaters, or wetlands. Whenever the existing quality of water is better than the quality of water established in the Basin Plan, such existing quality shall be maintained unless appropriate findings are made under Resolution No. 68-16. Degradation of the quality of waters of the State is not anticipated or authorized in the vicinity of the Landfill.
2. Bacteria – Waters shall not contain concentrations of coliform organisms attributable to human wastes. The median concentration of coliform organisms, over any seven-day period, shall be less than 1.1 most probable number per 100 milliliters in groundwaters.
3. Chemical Constituents – Groundwaters designated as Municipal and Domestic Supply (MUN) shall not contain concentrations of chemical constituents in excess of the Maximum Contaminant Level (MCL) or Secondary Maximum Contaminant Level (SMCL) based upon drinking water standards specified in title 22, CCR: Table 64431-A of section

64431 (Inorganic Chemicals), Table 64444-A of section 64444 (Organic Chemicals), Table 64449-A of section 64449 (SMCL – Consumer Acceptance Contaminant Levels), and Table 64449-B of section 64449 (SMCL – Consumer Acceptance Contaminant Level Ranges).

4. Chemicals – Waters shall not contain concentrations of chemical constituents that adversely affect the water for beneficial uses.
5. Radioactivity – Radionuclides shall not be present in concentrations that are deleterious to human, plant, animal, or aquatic life, or that result in the accumulation of radionuclides in the food chain to an extent that it presents a hazard to human, plant, animal, or aquatic life. Waters shall not contain concentrations of radionuclides in excess of limits specified in CCR, title 22, section 64443.
6. Taste and Odors – Groundwaters shall not contain taste or odor-producing substances in concentrations that cause nuisance or that adversely affect beneficial uses. For groundwaters designated as MUN, at a minimum, concentrations shall not exceed adopted SMCLs specified in Table 64449-A of section 64449 (SMCLs – Consumer Acceptance Contaminant Levels), and Table 64449-B of section 64449 (SMCLs – Consumer Acceptance Contaminant Level Ranges) of Title 22, CCR, including future changes as the changes take effect.
7. The waste discharge shall not result in any perceptible color, odor, taste, or foaming in surface or groundwaters.
8. The discharge shall not cause the presence of toxic substances that individually, collectively, or cumulatively cause detrimental physiological responses in human, plant, animal, or aquatic life in any surface or groundwater of the Antelope Valley.

II. REQUIREMENTS AND PROHIBITIONS

A. General

1. The discharge shall not cause pollution as defined in section 13050 of the California Water Code, or a threatened pollution.
2. The discharge shall not cause a nuisance as defined in section 13050 of the California Water Code.
3. The discharge of solid wastes, leachate, or any other deleterious

material to the groundwaters of the Antelope Valley is prohibited.

4. The closed disposal site shall be protected from inundation, washout, or erosion of wastes and erosion of covering materials resulting from a storm or a flood having recurrence interval of once in 100 years.
5. Surface drainage from tributary areas, and internal site drainage from surface or subsurface sources shall not contact or percolate through solid wastes discharged at the site.
6. The exterior surfaces of the closed disposal site shall be graded to promote lateral runoff of precipitation and to prevent ponding.
7. Water used for dust control operations shall be limited to a minimal amount. A "minimal amount" is defined as that amount which will not result in runoff.
8. All water used for dust control shall not contain detected concentrations of VOCs
9. The Discharger shall remove and relocate any waste that is or has been discharged at the closed disposal site in violation of these requirements.
10. At any given time, the concentration limit for each constituent of concern shall be equal to the background value of that constituent.
11. The concentration limits for each constituent of concern shall not be exceeded.
12. Any discharge that causes violation of any narrative water quality objective contained in the Basin Plan, including the Nondegradation Objective, is prohibited.
13. Any discharge that causes violation of any numeric water quality objective contained in the Basin Plan is prohibited.
14. Where any numeric or narrative water quality objective or receiving waters limit contained in the Basin Plan is already being violated, any discharge that causes further degradation or pollution is prohibited.
15. At closure, all facilities shall be closed in accordance with the Final Closure/Post-Closure Plan accepted by the Water Board.

16. The Discharger shall immediately notify the Water Board of any flooding, slope failure, or other change in site conditions that could impair the integrity of waste containment facilities or of precipitation and drainage control structures.
 17. Pursuant to 27 CCR section 21090, subdivision (a)(4)(C), the Discharger shall repair, in a timely manner, any breach or other cover problem discovered during the periodic inspection of the Landfill cover. Repairs to the upper soil cover material shall follow a Construction Quality Assurance (CQA) plan, as required in 27 CCR section 20323 and defined in 27 CCR section 20324 and as specified in the Final Closure/Post-Closure Plan.
 18. Pursuant to 27 CCR, section 20324, the Discharger is required to carry out the construction of the final cover in accordance with a CQA plan certified by an appropriately registered professional. If the Water Board finds that any construction of the final cover system was undertaken in the absence of the CQA plan that satisfies the requirements of 27 CCR section 20324, the Water Board shall require the Discharger to undertake any corrective construction needed to achieve such compliance.
- B. Detection Monitoring Program
- The Discharger shall maintain a DMP as required in 27 CCR section 20420.
- C. Evaluation Monitoring Program
- The Discharger shall maintain the EMP as long as there is evidence of a release from the Landfill as required in 27 CCR section 20425 or until a CAP is implemented.
- D. Corrective Action Program
- The Discharger shall institute a CAP when required pursuant to 27 CCR section 20430.
- E. Storm Water Requirements
- In accordance with the federal Clean Water Act, the Discharger must obtain and comply with NPDES permit requirements for discharges of storm water associated with industrial activities (State Water Board's General Permit for Discharges of Storm Water Associated With Industrial Activities) and

construction activities (State Water Board's NPDES General Permit for Discharges Associated With Construction Activities).

III. DATA ANALYSIS

A. Statistical Analyses

Monitoring data shall be collected according to the DMP for the Landfill. Statistical analyses of DMP data from groundwater and the unsaturated zone shall be conducted. Analyses shall be conducted in accordance with statistical methods detailed in MRP R6T-2010-0025 to determine if the data indicate evidence of a release from the Landfill.

B. Non-statistical Analyses

The Discharger shall determine whether there is significant physical evidence of a release from the Landfill. Significant physical evidence may include unexplained volumetric changes in the Landfill, unexplained stress in biological communities, unexplained changes in soil characteristics, visible signs of leachate migration, and unexplained water table mounding beneath or adjacent to the Landfill, or any other change in the environment that could reasonably be expected to be the result of a release from the Landfill.

C. Verification Procedures

1. The Discharger shall immediately initiate verification procedures as specified below whenever there is a determination by the Discharger or Water Board Executive Officer that there is statistical or non-statistical evidence of a release. If the Discharger declines the opportunity to conduct verification procedures, the Discharger shall submit a technical report as described below under the heading Technical Report Without Verification Procedures.
2. The verification procedure shall only be performed for the constituent(s) that has shown evidence of a release, and shall be performed for those monitoring points at which a release is indicated.
3. The Discharger shall either conduct a composite retest using data from the initial sampling event with all data obtained from the resampling event or shall conduct a discrete retest in which only data obtained from the resampling event shall be analyzed in order to verify evidence of a release.
4. The Discharger shall report to the Water Board by certified mail the

results of the verification procedure, as well as all concentration data collected for use in the retest, within seven days of the last laboratory analysis.

5. The Discharger shall determine, within 45 days after completion of sampling, whether there is statistically significant evidence of a release from the Landfill at each monitoring point. If there is statistically significant evidence of a release, the Discharger shall immediately notify the Water Board by certified mail. The Executive Officer may make an independent finding that there is statistical evidence of a release.
6. If the Discharger or Executive Officer verifies evidence of a release, the Discharger is required to submit, within 90 days of a determination that there is or was a release, a technical report pursuant to California Water Code section 13267(b). The report shall propose an EMP **OR** make a demonstration to the Water Board that there is a source other than the Landfill that caused evidence of a release.

D. Technical Report Without Verification Procedures

If the Discharger chooses not to initiate verification procedures, a technical report shall be submitted pursuant to California Water Code section 13267(b). The report shall propose an EMP **OR** make a demonstration that the release did not originate from the Landfill.

IV. PROVISIONS

A. Rescission of Waste Discharge Requirements

Board Order Nos. 6-72-60, 6-88-25, 6-88-25-A1, 6-93-100-11, and 6-96-13 are hereby rescinded, except for enforcement purposes.

B. Final Closure/Post-Closure Plan Approval

The Final Closure/Post-Closure is approved.

C. Standard Provisions

The Discharger shall comply with the "Standard Provisions for Waste Discharge Requirements," dated September 1, 1994, in Attachment C, which is made part of this Order.

D. Monitoring and Reporting

1. Pursuant to the California Water Code section 13267(b), the Discharger shall comply with the MRP R6T-2009-0025 or as specified by the Executive Officer.
2. The Discharger shall comply with the "General Provisions for Monitoring and Reporting," dated September 1, 1994, which is attached to and made part of the MRP R6T-2009-0025.

E. Completion Monitoring

The Final Closure/Post-Closure Plan shall be updated if there is a substantial change in operations. A report shall be submitted annually indicating conformance with existing operations.

V. TIME SCHEDULE

A. Cost Estimates for Corrective Action and Financial Assurance For Known or Reasonably Foreseeable Release

1. **By August 31, 2010**, the Discharger shall submit a cost estimate for initiating and completing corrective action for all known or reasonably foreseeable releases for the Landfill in accordance with 27 CCR sections 22221 and 20380 et seq.

2. Financial Assurance Documents

The Discharger shall continue to submit reports providing evidence that adequate financial assurance pursuant to the requirements of the WDRs has been provided for closure, post-closure, and all known or reasonably foreseeable releases. Evidence shall include the total amount of money available in the fund developed by the Discharger. In addition, the Discharger shall either provide evidence that the amount of financial assurance is still adequate or increase the amount of financial assurance by the appropriate amount. An increase may be necessary due to inflation, a change in regulatory requirements, a change in the approved Final Closure/Post-Closure Plan, or any other unforeseen events.

B. Closure Certification Report

Pursuant to 27 CCR section 21880, the Discharger shall submit to the Water Board a certification, under penalty of perjury, that the solid waste landfill has been closed in accordance with the Final Closure/Post-Closure Plan and the

Construction Quality Assurance plan. This report shall be submitted to the Water Board no later than 180 days after completion of construction activities. The certification shall be completed by a California registered civil engineer or a California certified engineering geologist and include a report with supporting documentation.

C. Construction and Industrial NPDES Permits

1. The Discharger shall enroll in the State Water Board's General Permit for Discharges of Storm Water Associated with Construction Activities, **by August 31, 2010.**
2. The Discharger shall enroll in the State Water Board's NPDES General Permit for Discharges Associated with Industrial Activities, **by August 31, 2010.**

I, Harold J. Singer, Executive Officer, do hereby certify that the foregoing is a full, true, and correct copy of an Order adopted by California Regional Water Quality Control Board, Lahontan Region, on June 9, 2010.



HAROLD J. SINGER
EXECUTIVE OFFICER

- Attachments:
- A. Location Map
 - B. Topographic Map
 - C. Standard Provisions for Waste Discharge Requirements

ATTACHMENT A

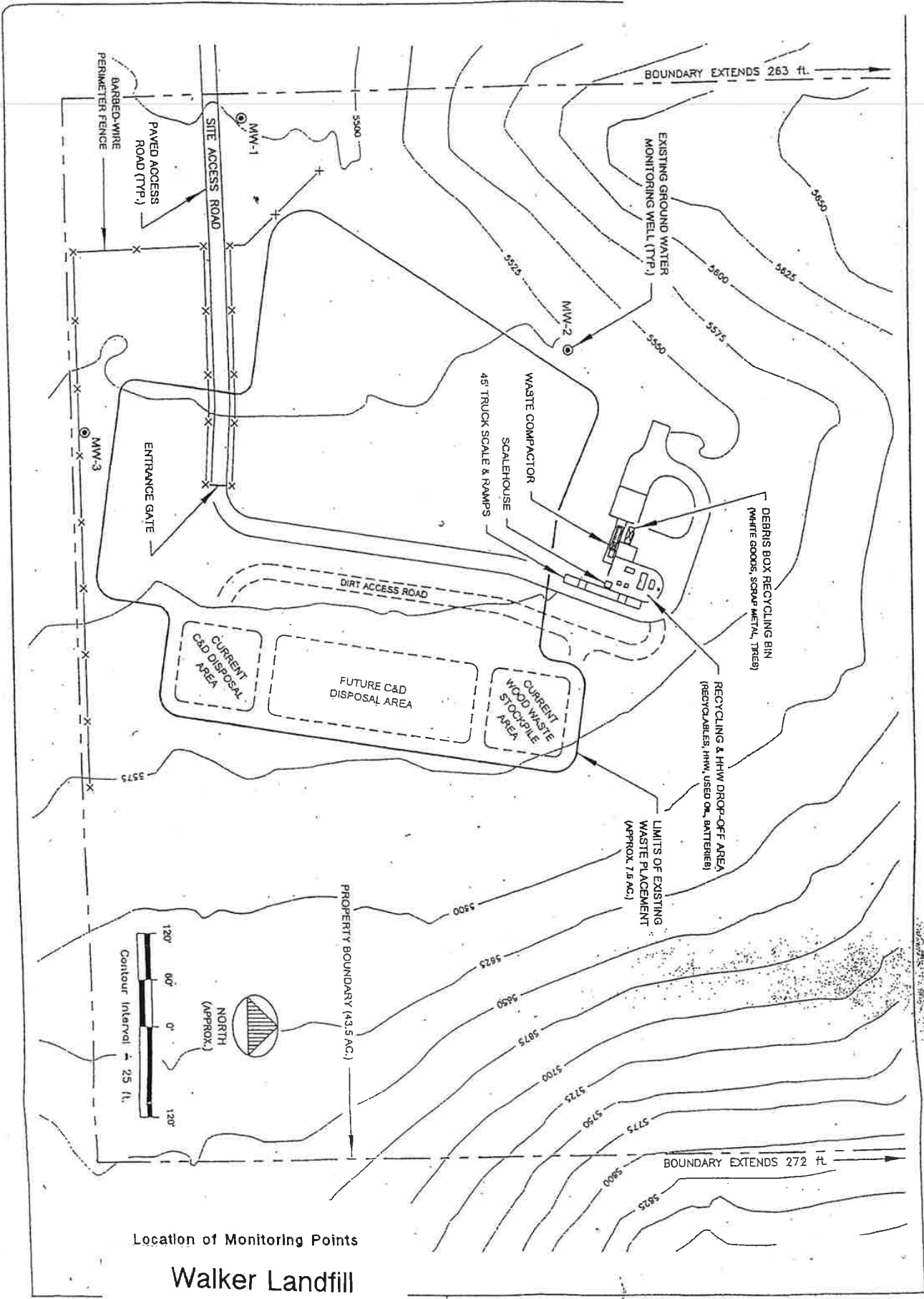

Location of Monitoring Points
Walker Landfill

ATTACHMENT B

CALIFORNIA REGIONAL WATER QUALITY CONTROL BOARD
LAHONTAN REGION

GENERAL PROVISIONS
FOR MONITORING AND REPORTING

1. SAMPLING AND ANALYSIS

- a. All analyses shall be performed in accordance with the current edition(s) of the following documents:
 - i. Standard Methods for the Examination of Water and Wastewater
 - ii. Methods for Chemical Analysis of Water and Wastes, EPA
- b. All analyses shall be performed in a laboratory certified to perform such analyses by the California State Department of Health Services or a laboratory approved by the Regional Board Executive Officer. Specific methods of analysis must be identified on each laboratory report.
- c. Any modifications to the above methods to eliminate known interferences shall be reported with the sample results. The methods used shall also be reported. If methods other than EPA-approved methods or Standard Methods are used, the exact methodology must be submitted for review and must be approved by the Regional Board Executive Officer prior to use.
- d. The discharger shall establish chain-of-custody procedures to insure that specific individuals are responsible for sample integrity from commencement of sample collection through delivery to an approved laboratory. Sample collection, storage, and analysis shall be conducted in accordance with an approved Sampling and Analysis Plan (SAP). The most recent version of the approved SAP shall be kept at the facility.
- e. The discharger shall calibrate and perform maintenance procedures on all monitoring instruments and equipment to ensure accuracy of measurements, or shall insure that both activities will be conducted. The calibration of any wastewater flow measuring device shall be recorded and maintained in the permanent log book described in 2.b, below.
- f. A grab sample is defined as an individual sample collected in fewer than 15 minutes.
- g. A composite sample is defined as a combination of no fewer than eight individual samples obtained over the specified sampling period at equal intervals. The volume of each individual sample shall be proportional to the discharge flow rate at the time of sampling. The sampling period shall equal the discharge period, or 24 hours, whichever period is shorter.

2. OPERATIONAL REQUIREMENTS

a. Sample Results

Pursuant to California Water Code Section 13267(b), the discharger shall maintain all sampling and analytical results including: strip charts; date, exact place, and time of sampling; date analyses were performed; sample collector's name; analyst's name; analytical techniques used; and results of all analyses. Such records shall be retained for a minimum of three years. This period of retention shall be extended during the course of any unresolved litigation regarding this discharge, or when requested by the Regional Board.

b. Operational Log

Pursuant to California Water Code Section 13267(b), an operation and maintenance log shall be maintained at the facility. All monitoring and reporting data shall be recorded in a permanent log book.

3. REPORTING

- a. For every item where the requirements are not met, the discharger shall submit a statement of the actions undertaken or proposed which will bring the discharge into full compliance with requirements at the earliest time, and shall submit a timetable for correction.
- b. Pursuant to California Water Code Section 13267(b), all sampling and analytical results shall be made available to the Regional Board upon request. Results shall be retained for a minimum of three years. This period of retention shall be extended during the course of any unresolved litigation regarding this discharge, or when requested by the Regional Board.
- c. The discharger shall provide a brief summary of any operational problems and maintenance activities to the Board with each monitoring report. Any modifications or additions to, or any major maintenance conducted on, or any major problems occurring to the wastewater conveyance system, treatment facilities, or disposal facilities shall be included in this summary.
- d. Monitoring reports shall be signed by:
 - i. In the case of a corporation, by a principal executive officer at least of the level of vice-president or his duly authorized representative, if such representative is responsible for the overall operation of the facility from which the discharge originates;
 - ii. In the case of a partnership, by a general partner;
 - iii. In the case of a sole proprietorship, by the proprietor; or

iv. In the case of a municipal, state or other public facility, by either a principal executive officer, ranking elected official, or other duly authorized employee.

e. Monitoring reports are to include the following:

i. Name and telephone number of individual who can answer questions about the report.

ii. The Monitoring and Reporting Program Number.

iii. WDID Number 6A260004000.

f. Modifications

This Monitoring and Reporting Program may be modified at the discretion of the Regional Board Executive Officer.

4. NONCOMPLIANCE

Under Section 13268 of the Water Code, any person failing or refusing to furnish technical or monitoring reports, or falsifying any information provided therein, is guilty of a misdemeanor and may be liable civilly in an amount of up to one thousand dollars (\$1,000) for each day of violation.

T:FORMS/M&R PROVISIONS

ATTACHMENT C

Self Monitoring Report Cover Letter Form

Date _____

California Regional Water Quality Control Board
Lahontan Region
2501 Lake Tahoe Boulevard
South Lake Tahoe, CA 96150

Facility Name: _____

Address: _____

Contact Person: _____

Job Title: _____

Phone: _____

Email: _____

WDR/NPDES Order Number: _____

WDID Number: _____

Type of Report (circle one): Monthly Quarterly Semi-Annual Annual Other
Month(s) JAN FEB MAR APR MAY JUN
(Circle applicable month(s)*: JUL AUG SEP OCT NOV DEC

*annual Reports (circle the first month of the reporting period)

Year: _____

Violation(s)? (Please check one): _____ NO _____ YES*

*If YES is marked complete a-g (Attach Additional information as necessary)

a) Brief Description of Violation: _____

b) Section(s) of WDRs/NPDES Permit Violated:

c) Reported Value(s) or Volume:

d) WDRs/NPDES Limit/Condition:

e) Date(s) and Duration of Violation(s):

f) Explanation of Cause(s):

g) Corrective Action(s) (Specify actions taken and a schedule for actions to be taken):

I certify under penalty of law that this document and all attachments were prepared under my direction or supervision following a system designed to ensure that qualified personnel properly gather and evaluate the information submitted. Based on my knowledge of the person(s) who manage the system, or those directly responsible for data gathering, the information submitted is, to the best of my knowledge and belief, true, accurate, and complete. I am aware that there are significant penalties for submitting false information, including the possibility of fine and imprisonment.

Signature: _____

Name: _____

Title: _____

CALIFORNIA REGIONAL WATER QUALITY CONTROL BOARD
LAHONTAN REGION

**MONITORING AND REPORTING PROGRAM NO. R6T-2010-0025
WDID NO. 6A260012000**

FOR

**MONO COUNTY DEPARTMENT OF PUBLIC WORKS
WALKER CLASS III LANDFILL**

Mono County

I. WATER QUALITY PROTECTION STANDARD

Water Quality Protection Standard is required by Title 27 of the California Code of Regulations (27 CCR) to assure the earliest possible detection of a release from the Walker Landfill (Landfill) to underlying soil and/or groundwater. The Water Quality Protection Standard shall consist of the list of constituents of concern, the concentration limits, the Point of Compliance and all Monitoring Points. This Water Quality Protection Standard shall apply during the closure period, the post-closure maintenance period, and during any compliance period.

The Landfill is currently in the Evaluation Monitoring Program (EMP) for monitoring wells that have been impacted by a release from the Landfill and a Detection Monitoring Program (DMP) for any wells that show no evidence of a release. This Monitoring and Reporting Program maintains the EMP and DMP for the Landfill.

II. MONITORING

Since 1997, the monitoring network has consisted of two downgradient wells, MW-1 and MW-3, and one upgradient well, MW-2 (Attachment A). These wells have been used for the DMP and EMP. The Discharger will report results for all three wells in subsequent events as directed in this MRP.

Since the EMP began in 1997, MW-1 through MW-3 have been sampled quarterly for five indicator parameters (pH, total dissolved solids [TDS], chloride, nitrate as nitrogen, and sulfate) and volatile organic compounds (VOCs) listed in 40 CFR Part 258, Appendix II. The results of the EMP have revealed the following trends.

- TDS, chloride, and sulfate concentrations have increased in the two downgradient wells while remaining relatively stable in the upgradient well.
- Freon 12 and Freon 11 have consistently been detected at low concentrations in MW-3.

- Two other VOCs (tetrachloroethylene and 1,1-dichloroethane) have been detected sporadically at low concentrations in the downgradient well MW-3.

None of the detected constituents have exceeded maximum contaminant levels (MCLs). However, the EMP indicates that the Landfill is impacting groundwater quality and that the impacts appear to be increasing over time. The Discharger's Final Closure and Post-Closure Maintenance Plan (Final Closure/Post-Closure Plan) include measures that are designed to remediate these impacts. The landfill cover and storm water run-on designs will decrease infiltration into the waste and will reduce or eliminate the impacts to groundwater. If the groundwater impacts are not remediated by these measures, additional actions may be necessary to maintain groundwater water quality pursuant to State Board Resolution No. 68-16.

A. Landfill Cover Monitoring and Maintenance

The Discharger will install a final cover over the closed Landfill as specified in the Final Closure/Post-Closure Plan. Inspection and Maintenance procedures will be as specified in the Final Closure/Post-Closure Plan and will include the following.

Quarterly, the Discharger must inspect the condition of the cover to ensure the integrity of the cover and evaluate the cover's capability to promote runoff and prevent ponding on the cover. The quarterly inspections should be approximately every three months. The Discharger must provide reports on the inspections **semiannually**. The quarterly inspection must consist of the following.

1. The Discharger must inspect the cover for integrity and inspect the wood chips and vegetation for appropriate coverage.
2. The Discharger must also inspect the general integrity of the Landfill for signs of settlement, subsidence, and erosion.
3. The Discharger must inspect the drainage system for the entire site including that which will divert water from the Landfill and prevent run-on.
4. During sampling events, groundwater monitoring wells will be inspected for damage.
5. Any adverse conditions found in the visual inspection must be documented and corrected. Documentation of the correction must be submitted with each semiannual report.

B. Groundwater

The Landfill presently has three groundwater monitoring wells to monitor groundwater quality. There is one upgradient monitoring well, MW-2, and two downgradient wells, MW-1 and MW-3, which are used to detect a potential release from the Landfill. Attachment A shows the location of the three monitoring wells.

1. Point of Compliance and Monitoring Points

The Point of Compliance as defined in 27 CCR section 20405 is "a vertical surface located at the hydraulically downgradient limit of the waste management unit that extends through the uppermost aquifer underlying the unit." Groundwater monitoring wells have been installed upgradient (MW-2) and downgradient (point of compliance monitoring wells MW1 and MW-3) of the Landfill. The locations of the groundwater monitoring wells are shown on Attachment A, which is made part of this Monitoring and Reporting Program.

2. Aquifer characteristics

The parameters listed in Table 1.a must be measured **quarterly** (i.e., every three months) and reported in tabular form **semiannually**. The required information to be calculated from the measured parameters is listed below in Table 1.b. An area map must be included to show the groundwater flow direction and estimated groundwater gradient.

Table No. 1.a
Groundwater Field Measurements

Parameter	Units
depth to groundwater	feet below ground
dissolved oxygen	mg/L
electrical conductivity	micromhos/cm
pH	pH units
Temperature	degree F or C
Turbidity	NTUs

**Table 1.b
Groundwater Calculations**

Parameter	Units
static water level	feet above mean sea level
slope of groundwater gradient	feet per foot
direction of groundwater gradient	degrees from true north

3. Groundwater Purging

Groundwater samples must be collected after the wells have been purged in accordance with California Environmental Protection Agency guidance document, *Representative Sampling of Groundwater for Hazardous Substances*, revised February 2008 (see: http://www.dtsc.ca.gov/SiteCleanup/upload/SMP_Representative_Sampling_GroundWater.pdf). The required stability parameters and criteria from this guidance are summarized in Table 1.c.

**Table 1.c
Stabilization Parameters and Criteria**

Parameter	Criteria
temperature	± 3% of reading (minimum of ± 0.2 C)
pH	+/- 0.1
specific electrical conductance	+/- 3%
oxidation-reduction potential	+/- 10 millivolts
dissolved oxygen	+/- 0.3 milligrams per liter

4. Monitoring Parameters and Sampling Frequency

The Discharger shall analyze all samples from all Groundwater Monitoring Points as specified under Part II B.1 of this Monitoring and Reporting Program for the monitoring parameters listed in **Table 1.d**. Groundwater sampling for monitoring parameters will be collected **quarterly** (every three months) and reported **semiannually**.

**Table 1.d
Monitoring Parameters**

Parameter	USEPA Method ⁽¹⁾	Units
chloride	300.0	mg/L
dissolved oxygen ⁽²⁾	field	mg/L
electrical conductivity ⁽²⁾	field	mmhos/cm
nitrate as nitrogen	9200	mg/L
pH ⁽²⁾	field	pH units
sulfate	300.0	mg/L
temperature ⁽²⁾	field	F/C
total dissolved solids	160.1	mg/L
turbidity ⁽²⁾	field	NTU
antimony ⁽³⁾	7062	mg/L
arsenic ⁽³⁾	7060	mg/L
barium ⁽³⁾	6010B	mg/L
beryllium ⁽³⁾	6010B	mg/L
cadmium ⁽³⁾	6010B	mg/L
chromium ⁽³⁾	6010B	mg/L
cobalt ⁽³⁾	6010B	mg/L
copper ⁽³⁾	6010B	mg/L
lead ⁽³⁾	7421	mg/L
nickel ⁽³⁾	6010B	mg/L
selenium ⁽³⁾	7740	mg/L
silver ⁽³⁾	6010B	mg/L
thallium ⁽³⁾	7841	mg/L
vanadium ⁽³⁾	6010B	mg/L
zinc ⁽³⁾	6010B	mg/L
VOCs ⁽⁴⁾	8260B	mg/L

footnotes:

- (1) An alternate method may be proposed and used if acceptable to the Executive Officer.
- (2) With the exception of temperature and turbidity, these field parameters must be tabulated and graphed in monitoring reports; however, development of statistical background levels is not required.
- (3) Inorganic constituents from Appendix I, 40 CFR Part 258 (Subtitle D).
- (4) The VOCs monitoring parameter includes all VOCs detectable using USEPA Method 8260B, including at least all 47 organic constituents listed in Appendix I to 40 CFR Part 258 and all unidentified peaks.

5. Constituents of Concern Monitoring and Sampling Frequency

Constituents of Concern (COCs) are listed in Table 1.e. Monitoring for COCs shall encompass only those constituents that are not also serving as monitoring parameters (Table 1.d). Analysis for COCs shall be carried out **once every five years** at each of the site’s groundwater monitoring points. The COC monitoring shall be carried out in the **spring of year one** (during period of seasonal high groundwater level) and the **fall of the fifth year** (during period of seasonal low groundwater level). Monitoring points that have not previously been sampled for COCs shall be sampled and analyzed for all COCs **within three months of this program becoming effective**. This program becomes effective on the date the Board approves these WDRs. This list is from Appendix II of 40 CFR Part 258, which lists pollutants required to be monitored at the Landfill on a minimum frequency of once every five years. The following constituents will be reported in the annual report. For reporting in the annual reports, if no samples are collected that year, the year the last samples were collected and the year for the next required sampling will be identified in the report.

**Table 1.e
Constituents of Concern**

Constituents of Concern	USEPA Method ⁽¹⁾
chlorinated herbicides	8150
cyanide	9010
nonhalogenated volatiles	8015
organochlorine pesticides and PCBs ⁽²⁾	8080
organophosphorous pesticides	8041A
semi-VOCs	8270
sulfide	9030

Footnotes:

(1) An alternate method may be proposed and used if acceptable to the Executive Officer.

(2) PCBs are polychlorinated biphenyls.

III. DATA ANALYSES

All data analyses methods (statistical or non-statistical) shall meet the requirements of 27 CCR section 20415(e)(9).

A. General Non-statistical Methods

Evaluation of data will be conducted using non-statistical methods to determine if any new releases from the Landfill have occurred. Non-statistical analysis shall be as follows.

1. Physical Evidence

Physical evidence can include vegetation loss, unexplained volumetric changes in the Landfill, groundwater mounding or soil discoloration. Each semiannual report shall comment on the absence or presence of physical evidence of a release.

2. Time Series Plots

Each semiannual report must include time series plots for groundwater monitoring parameters. Time series plots are not required for parameters that have never been detected above their method detection limit (as specified by the applicable USEPA Method) or if there are less than four quarters of data. Evidence of a release may include trends of increasing concentrations of one or more constituent over time.

B. General Statistical Analysis Methods

For Detection Monitoring, the Discharger shall use statistical methods to analyze COCs and monitoring parameters that exhibit concentrations that equal or exceed their respective method detection limit in at least ten percent of applicable historical samples. The Discharger may propose and use any data analysis that meets the requirements of 27 CCR section 20415(e)(7). The report titled "Statistical Analysis of Groundwater Monitoring Data at RCRA Facilities" (USEPA, 1989) or subsequent versions may also be used to select the statistical test to use for comparing detection monitoring well data to background monitoring data. All statistical methods and programs proposed by the Discharger are subject to Executive Officer approval.

IV. REPORTING REQUIREMENTS

A. Semiannual Reports To Be Filed With the Lahontan Regional Water Quality Control Board (Water Board)

All monitoring reports submitted to the Water Board shall be transmitted using the cover letter form in Attachment C. An electronic copy of the cover letter form can be downloaded at: http://www.waterboards.ca.gov/lahontan/water_issues/available_documents/index.shtml. The following periodic reports shall be submitted to the Water Board in accordance to the following schedule.

1. Two semiannual reports are required per year, as follows:

<u>Report due date</u>	<u>Reporting Period</u>
February 15	July 1- Dec 31
August 15	January 1 – June 30

2. The reports must contain the following information.
 - a. Results of sampling and laboratory analysis of gas and groundwater sampling.
 - b. A map or aerial photograph showing the locations of monitoring points.
 - c. For each monitored groundwater body, a description and graphical presentation of the velocity and direction of groundwater flow under and around the Landfill, based upon water level elevations taken during the collection of the water quality data submitted in the report.
 - d. If the Discharger has previously submitted a detailed time schedule for correcting requirement violations, a reference to the correspondence transmitting this schedule will be satisfactory. If no violations have occurred since the last submittal, this shall be stated in the letter of transmittal.
 - e. The reports must contain a description of the conditions of the cover materials. Specifically, comments regarding any subsidence or soil cover washouts that have occurred and the capability of the cover to promote runoff and prevent ponding should be included. In the case where subsidence, washouts or other damage to the cover is noted, the report shall indicate the actions taken to repair cover material so that the event will not reoccur.
 - f. An Executive Summary must accompany each report. The summary shall include a discussion of any requirement violations found since the last report was submitted, and shall describe actions taken or planned for correcting those violations.

B. Other Reports To Be Filed With The Board

1. Notice of Tentative Release

If the appropriate statistical or non-statistical data analysis indicates, for a given constituent of concern, that a release is tentatively identified, Discharger shall:

- a. Immediately notify the Water Board verbally as to the monitoring point(s) and constituent(s) or parameter(s) involved;
- b. Provide written notification by certified mail within seven days of such determination (27 CCR section 20420(j)). The notification should indicate the Discharger's intent to conduct verification sampling, initiate evaluation monitoring procedures, or demonstrate that a source other than the Landfill is responsible for the release.
- c. If the Discharger chooses to attempt to demonstrate that a source other than the Landfill is responsible for the release, the Discharger shall submit a supporting technical report within 90 days of detection of the release (27 CCR section 20420(k)).

2. Evaluation Monitoring

The Discharger shall, within 90 days of verifying a release, submit a technical report pursuant to California Water Code section 13267(b) proposing an EMP. If the Discharger decides not to conduct verification procedures, or decides not to make a demonstration that a source other than the Landfill is responsible for the release, the release will be considered verified.

3. Engineering Feasibility Study Report

The Discharger shall, within 180 days of verification of a release or detection, submit an Engineering Feasibility Study that shall contain corrective action measures to meet the requirements of 27 CCR section 20420(k)(6).

C. Electronic Submittals of Information

Pursuant to CCT title 23, section 3890, the Applicant shall submit reports, including soil, vapor and water data, prepared for the purpose of subsurface investigation or remediation of a discharge of waste to land subject to Division 2 of Title 27 electronically over the internet to the State Water Resources Control Board's Geotracker system. This requirement is in addition to, and not superseded by, any other applicable reporting requirement.

D. General Provisions

The Discharger shall comply with the "General Provisions for Monitoring and Reporting," dated September 1, 1994, which is attached to and made part of this Monitoring and Reporting Program (Attachment B).

E. Annual Report

On or before **February 15, 2011**, and on or before **February 15** every year thereafter, the Discharger shall submit an annual report to the Water Board for the period January to December. This report shall include the items described in the General Provisions for Monitoring and Reporting (Attachment B) and information that is required to be collected annually or less frequently. The Annual Report may be combined with the semiannual report for the period July 1 through Dec 31 .

F. Financial Assurance

On or before **February 15, 2011**, and on or before **February 15** every year thereafter, the Dischargers shall submit an annual financial assurance report to the Water Board. This report shall summarize the amount of money available in the fund. This report should also provide a demonstration that the amount of financial assurance is adequate, or the need to increase the amount of financial assurance based on inflation or other factors.

Ordered by: 
HAROLD J. SINGER
EXECUTIVE OFFICER

Dated: June 9, 2010

- Attachment: A. Location of Monitoring Points
B. General Provisions for Monitoring and Reporting
C. Transmittal Cover Letter Form

ATTACHMENT A

Walker Landfill
Location Map

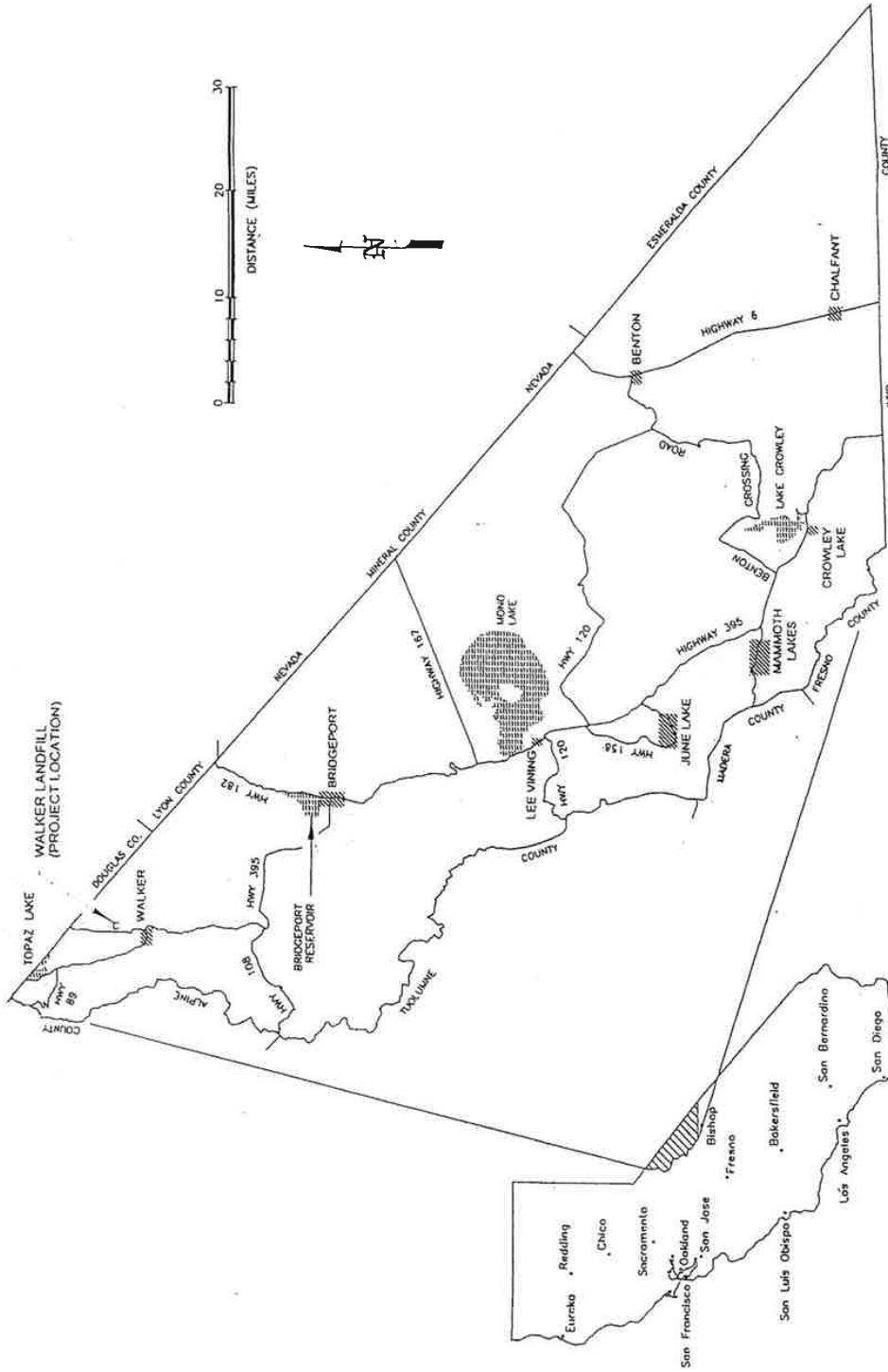

ATTACHMENT B

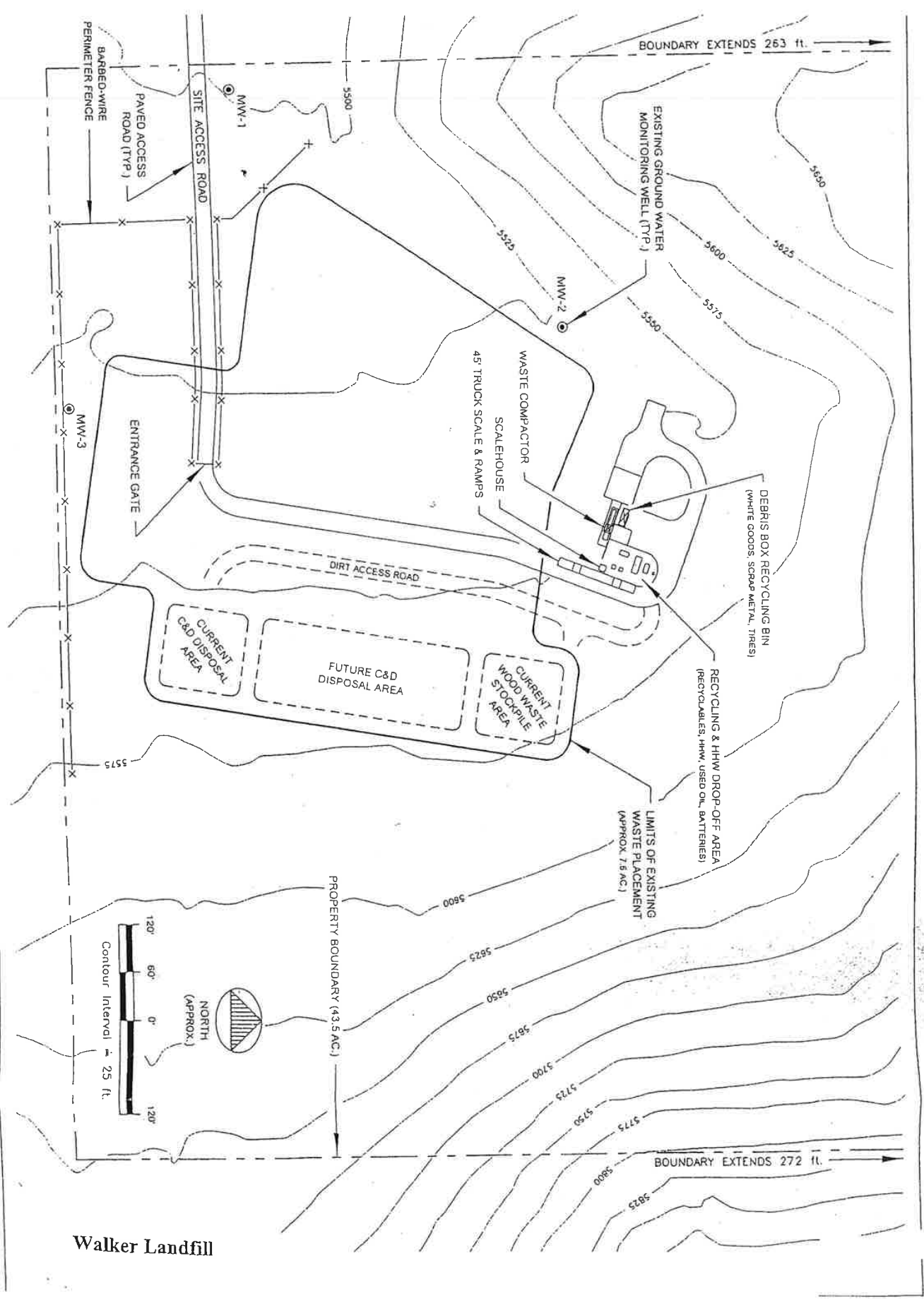

Walker Landfill

ATTACHMENT C

CALIFORNIA REGIONAL WATER QUALITY CONTROL BOARD
LAHONTAN REGION

STANDARD PROVISIONS
FOR WASTE DISCHARGE REQUIREMENTS

1. Inspection and Entry

The Discharger shall permit Regional Board staff:

- a. to enter upon premises in which an effluent source is located or in which any required records are kept;
- b. to copy any records relating to the discharge or relating to compliance with the Waste Discharge Requirements (WDRs);
- c. to inspect monitoring equipment or records; and
- d. to sample any discharge.

2. Reporting Requirements

- a. Pursuant to California Water Code 13267(b), the Discharger shall immediately notify the Regional Board by telephone whenever an adverse condition occurred as a result of this discharge; written confirmation shall follow within two weeks. An adverse condition includes, but is not limited to, spills of petroleum products or toxic chemicals, or damage to control facilities that could affect compliance.
- b. Pursuant to California Water Code Section 13260 (c), any proposed material change in the character of the waste, manner or method of treatment or disposal, increase of discharge, or location of discharge, shall be reported to the Regional Board. Any such proposal shall be reported to the Regional Board at least 120 days in advance of implementation. This shall include, but not be limited to, all significant soil disturbances.
- c. The Owners/Discharger of property subject to WDRs shall be considered to have a continuing responsibility for ensuring compliance with applicable WDRs in the operations or use of the owned property. Any change in the ownership and/or operation of property subject to the WDRs shall be reported to the Regional Board. Notification of applicable WDRs shall be furnished in writing to the new owners and/or operators and a copy of such notification shall be sent to the Regional Board.
- d. If a Discharger becomes aware that any information submitted to the Regional Board is incorrect, the Discharger shall immediately notify the Regional Board, in writing, and correct that information.

- e. Reports required by the WDRs, and other information requested by the Regional Board, must be signed by a duly authorized representative of the Discharger. Under Section 13268 of the California Water Code, any person failing or refusing to furnish technical or monitoring reports, or falsifying any information provided therein, is guilty of a misdemeanor and may be liable civilly in an amount of up to one thousand dollars (\$1,000) for each day of violation.
- f. If the Discharger becomes aware that their WDRs (or permit) are no longer needed (because the project will not be built or the discharge will cease) the Discharger shall notify the Regional Board in writing and request that their WDRs (or permit) be rescinded.

3. Right to Revise WDRs

The Regional Board reserves the privilege of changing all or any portion of the WDRs upon legal notice to and after opportunity to be heard is given to all concerned parties.

4. Duty to Comply

Failure to comply with the WDRs may constitute a violation of the California Water Code and is grounds for enforcement action or for permit termination, revocation and re-issuance, or modification.

5. Duty to Mitigate

The Discharger shall take all reasonable steps to minimize or prevent any discharge in violation of the WDRs which has a reasonable likelihood of adversely affecting human health or the environment.

6. Proper Operation and Maintenance

The Discharger shall at all times properly operate and maintain all facilities and systems of treatment and control (and related appurtenances) that are installed or used by the Discharger to achieve compliance with the WDRs. Proper operation and maintenance includes adequate laboratory control, where appropriate, and appropriate quality assurance procedures. This provision requires the operation of backup or auxiliary facilities or similar systems that are installed by the Discharger, when necessary to achieve compliance with the conditions of the WDRs.

7. Waste Discharge Requirement Actions

The WDRs may be modified, revoked and reissued, or terminated for cause. The filing of a request by the Discharger for waste discharge requirement modification, revocation and re-issuance, termination, or a notification of planned changes or anticipated noncompliance, does not stay any of the WDRs conditions.

8. Property Rights

The WDRs do not convey any property rights of any sort, or any exclusive privileges, nor does it authorize any injury to private property or any invasion of personal rights, nor any infringement of federal, state or local laws or regulations.

9. Enforcement

The California Water Code provides for civil liability and criminal penalties for violations or threatened violations of the WDRs including imposition of civil liability or referral to the Attorney General.

10. Availability

A copy of the WDRs shall be kept and maintained by the Discharger and be available at all times to operating personnel.

11. Severability

Provisions of the WDRs are severable. If any provision of the requirements is found invalid, the remainder of the requirements shall not be affected.

12. Public Access

General public access shall be effectively excluded from treatment and disposal facilities.

13. Transfers

Providing there is no material change in the operation of the facility, this Order may be transferred to a new owner or operation. The owner/operator must request the transfer in writing and receive written approval from the Regional Board's Executive Officer.

14. Definitions

- a. "Surface waters" as used in this Order, include, but are not limited to, live streams, either perennial or ephemeral, which flow in natural or artificial water courses and natural lakes and artificial impoundments of waters. "Surface waters" does not include artificial water courses or impoundments used exclusively for wastewater disposal.
- b. "Ground waters" as used in this Order, include, but are not limited to, all subsurface waters being above atmospheric pressure and the capillary fringe of these waters.

15. Storm Protection

All facilities used for collection, transport, treatment, storage, or disposal of waste shall be adequately protected against overflow, washout, inundation, structural damage or a significant reduction in efficiency resulting from a storm or flood having a recurrence interval of once in 100 years.

APPENDIX I

Well Boring Logs

WELL CONSTRUCTION	CHEMICAL ANALYSES		BLOW COUNT	DEPTH (feet)	SAMPLE NUMBER	LITHOLOGY SYMBOL	U.S.C.S. DESIGNATION	SOIL DESCRIPTION
	LABORATORY	FIELD						
Above ground locking steel well protection				0				M SILTY SAND (SM), light brown to tan, dry, some gravel, fine to coarse sand, trace cobble, (angular to subangular), moderately well graded
				5				
				10				
4-inch Schedule 40 PVC blank casing				15				At 14 ft. drilling becomes harder, increase in gravels and cobbles
Bentonite/cement grout				20				GRAVELLY SILTY SAND (SM/GM), light brown to light gray brown, fine to coarse sand, trace cobble, (well graded)
				25				

SURFACE ELEVATION: 5493.00 feet
TOTAL DEPTH: 263.0 feet
DATE DRILLED: 6-6-88

LOGGED BY: JJ
SUPERVISED BY: RHD
DIAMETER of BORING: 10"
WATER ENCOUNTERED AT: 240.0 Feet



WALKER LANDFILL
MONO COUNTY, CALIFORNIA
LOG OF MONITORING WELL
MW-1A

PLATE
3.1.2

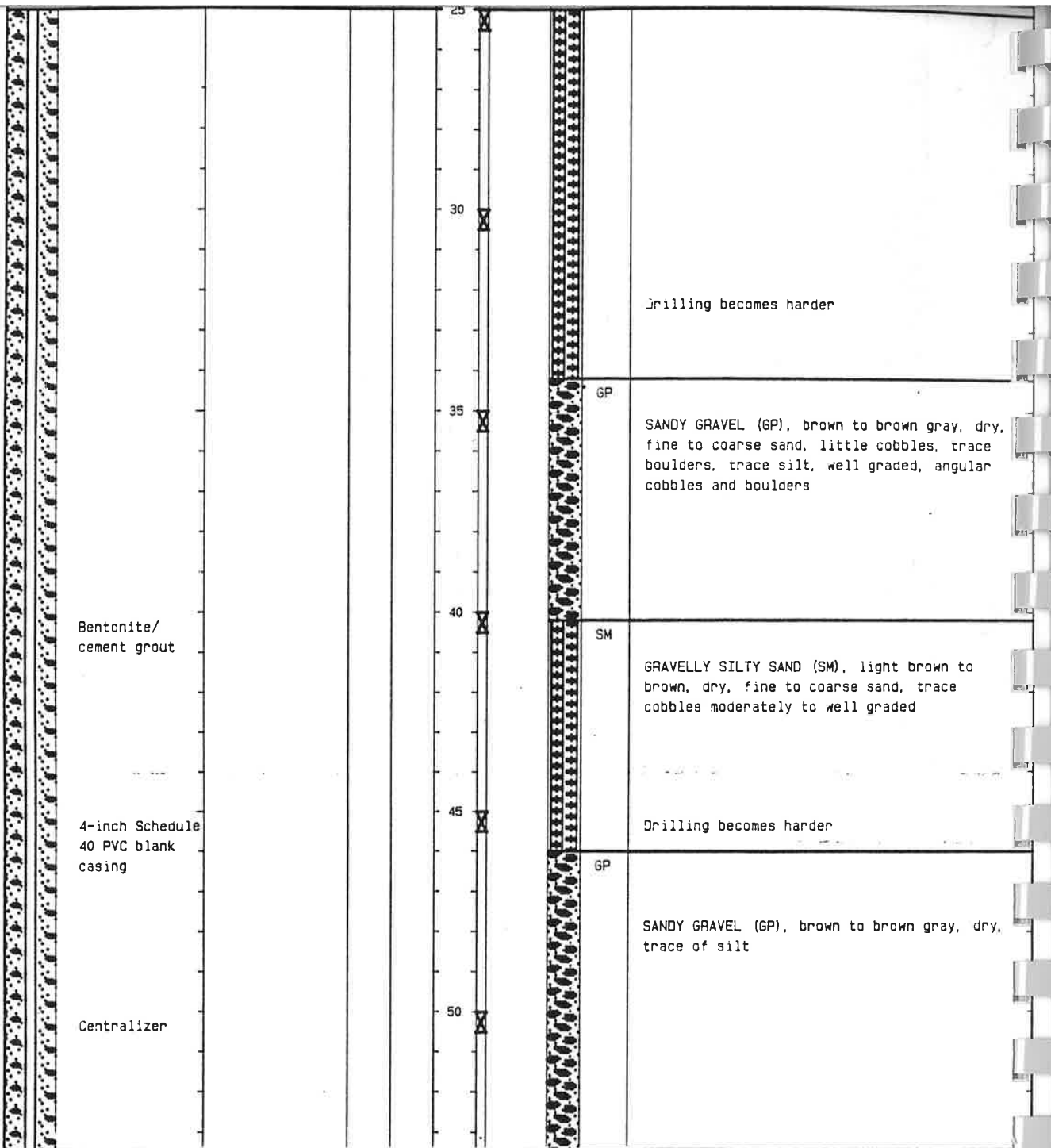

KLEINFELDER

PROJECT NUMBER 30-1477-06 PAGE 2 OF 10 January 1989

WALKER LANDFILL
 MONO COUNTY, CALIFORNIA
LOG OF MONITORING WELL
MW-1R (CONT.)

PLATE
3.1.2

WELL CONSTRUCTION	CHEMICAL ANALYSES		BLOW COUNT	DEPTH (feet)	SAMPLE NUMBER	LITHOLOGY SYMBOL	U.S.C.S. DESIGNATION	SOIL DESCRIPTION
	LABORATORY	FIELD						
4-inch Schedule 40 PVC blank casing Bentonite/cement grout				55			M	GRAVELLY SILTY SAND (SM), light brown to brown, dry, fine to coarse sand, trace cobbles
				60			GP	SANDY GRAVEL (GP), brown to brown gray, dry, fine to coarse sand, little cobbles, trace boulders, trace silt, well graded, angular cobbles and boulders Increase in cobbles and boulders, hard drilling
				65				
				70			RX	ROCK, basic mesozoic intrusive ranging from quartz diorite to gabbro, slightly fractured Begin to inject small amount of water. Intrusive gabbro with some quartz diorite
				75				
				80				



WALKER LANDFILL
MONO COUNTY, CALIFORNIA

LOG OF MONITORING WELL
MW-1R (CONT.)

PLATE
3.1.2

PROJECT NUMBER 30-1477-06 PAGE 3 OF 10 January 1989

WELL CONSTRUCTION	CHEMICAL ANALYSES		BLOW COUNT	DEPTH (feet)	SAMPLE NUMBER	LITHOLOGY SYMBOL	U.S.C.S. DESIGNATION	SOIL DESCRIPTION
	LABORATORY	FIELD						
4-inch Schedule 40 PVC blank casing				85				Intrusive gabbro with some quartz diorite
Bentonite/cement grout				90				
Centralizer				95				At 95 - 100 ft. fracture zone
				100				
				105				Intrusive gabbro with some quartz diorite
				110				

KLEINFELDER

WALKER LANDFILL
MONO COUNTY, CALIFORNIA

LOG OF MONITORING WELL
MW-1R (CONT.)

PLATE

3.1.2

PROJECT NUMBER 30-1477-06 PAGE 4 OF 10 January 1989

WELL CONSTRUCTION	CHEMICAL ANALYSES		BLOW COUNT	DEPTH (feet)	SAMPLE NUMBER	LITHOLOGY SYMBOL	U.S.C.S. DESIGNATION	SOIL DESCRIPTION
	LABORATORY	FIELD						
4-inch Schedule 40 PVC blank casing				115				Intrusive gabbro with some quartz diorite
Bentonite/cement grout				120				Stop circulating water
				125				Begin circulating water
				130				Intrusive gabbro with some quartz diorite
				135				

KLEINFELDER

WALKER LANDFILL
MONO COUNTY, CALIFORNIA

PLATE
3.1.2

LOG OF MONITORING WELL
MW-1A (CONT.)

PROJECT NUMBER 30-1477-06 PAGE 5 OF 10 January 1989

WELL CONSTRUCTION	CHEMICAL ANALYSES		BLOW COUNT	DEPTH (feet)	SAMPLE NUMBER	LITHOLOGY SYMBOL	U.S.C.S. DESIGNATION	SOIL DESCRIPTION
	LABORATORY	FIELD						
1-inch Schedule 40 PVC blank casing				140				
Centralizer				145				
Bentonite/cement grout				150				
				155				At 153 ft., begin to add foam to improve circulation
				160				At 162 ft., trace of prismatic quartz crystals, to 5mm in length, in cuttings
				165				At 167 ft., iron staining observed on some cuttings Intrusive gabbro with some quartz diorite

KLEINFELDER

WALKER LANDFILL
 MONO COUNTY, CALIFORNIA
LOG OF MONITORING WELL
MW-1R (CONT.)

PLATE
3.1.2

PROJECT NUMBER 30-1477-06 PAGE 6 OF 10 January 1989

WELL CONSTRUCTION	CHEMICAL ANALYSES		BLOW COUNT	DEPTH (feet)	SAMPLE NUMBER	LITHOLOGY SYMBOL	U.S. U.S. DESIGNATION	SOIL DESCRIPTION
	LABORATORY	FIELD						
4-inch Schedule 40 PVC blank casing				170				
				175				175 - 180 ft., fracture zone
Bentonite concrete grout				180				
				185				
				190				Intrusive gabbro with some quartz diorite
				195				190 ft., fracture zone
Top of bentonite plug								Drilling slightly easier
								Iron staining still present on some cuttings, suggest fractured material



WALKER LANDFILL
 MONO COUNTY, CALIFORNIA
LOG OF MONITORING WELL
MW-1R (CONT.)

PLATE
3.1.2

PROJECT NUMBER 30-1477-06 PAGE 7 OF 10 January 1989

WELL CONSTRUCTION	CHEMICAL ANALYSES		BLOW COUNT	DEPTH (feet)	SAMPLE NUMBER	LITHOLOGY SYMBOL	U.S.C.S. DESIGNATION	SOIL DESCRIPTION
	LABORATORY	FIELD						
Bentonite seal Centralizer 4-inch Schedule 40 PVC blank casing Sand pack #3 sand				200 205 210 215 220				Continue easier drilling Cuttings and drilling effort indicate material is fractured, essentially gabbro with increased quartz vein deposits. Iron staining more prevalent At 215 ft., color change from gray to brown, trace of fines (clay/silt/fine sand), in cuttings. As above. Trace sandy clay nodules (light brown) in cuttings

KLEINFELDER

WALKER LANDFILL
 MONO COUNTY, CALIFORNIA
LOG OF MONITORING WELL
MW-1R (CONT.)

PLATE
3.1.2

PROJECT NUMBER 30-1477-06 PAGE 8 OF 10 January 1989

WELL CONSTRUCTION	CHEMICAL ANALYSES		BLOW COUNT	DEPTH (feet)	SAMPLE NUMBER	LITHOLOGY SYMBOL	U.S.C.S. DESIGNATION	SOIL DESCRIPTION
	LABORATORY	FIELD						
Centralizer 4-inch Schedule 40 PVC Screen (0.02 slot) Sand pack #3 sand				225 230 235 240 245 250				At 234 ft, color change to original gray, sandy clay nodules absent, less iron staining than above At 237 ft, drilling becomes harder and slower Ground water encountered at approximately 240 ft. At 248 ft., drilling becomes slightly easier, fracture zone

KLEINFELDER

WALKER LANDFILL
 MONO COUNTY, CALIFORNIA
LOG OF MONITORING WELL
MW-1R (CONT.)

PLATE
3.1.2

PROJECT NUMBER 30-1477-06 PAGE 9 OF 10 January 1989

WELL CONSTRUCTION	CHEMICAL ANALYSES		BLOW COUNT	DEPTH (feet)	SAMPLE NUMBER	LITHOLOGY SYMBOL	U.S.C.S. DESIGNATION	SOIL DESCRIPTION
	LABORATORY	FIELD						
1-inch Schedule 40 PVC screen (0.02 slot) #3 Monterey sand Centralizer				255 260				Total depth of well: 260 feet below ground surface Total depth of boring: 263 ft. Well completed with: 4-inch Schedule 40 PVC screen (0.02 slot) 210 - 260 4-inch Schedule 40 PVC blank 0 - 210 Sand Pack (#3 sand) 200 - 263 Bentonite pellets 194 - 200 Bentonite/concrete grout 0 - 194 Centralizer placed at: 50 ft., 100 ft., 150 ft., 200 ft., 230 ft., 260 ft. Well completed with above ground locking well protection Well drilled using air percussion hammer
				265				
				270				
				275				
				280				

KLEINFELDER
 PROJECT NUMBER 30-1477-06 PAGE 10 OF 10 January 1989

WALKER LANDFILL
 MONO COUNTY, CALIFORNIA
LOG OF MONITORING WELL
MW-1A (CONT.)

PLATE
3.1.2

WELL CONSTRUCTION	CHEMICAL ANALYSES		BLOW COUNT	DEPTH (feet)	SAMPLE NUMBER	LITHOLOGY SYMBOL	U.S.C.S. DESIGNATION	SOIL DESCRIPTION
	LABORATORY	FIELD						
Above ground locking steel well protection				0			-P	SANDY GRAVEL (GP), tan, dry - moist, dense, minor silt; well graded, very fine to boulders & blocks up to 2 ft. diameter, subrounded - very angular Float comprised of: o Gabbro o Diorite o Quartz Surficial alluvial and colluvial material to approximately 5 - 6 ft. below surface Becomes difficult to drill with tricone bit at approximately 5 ft.
Centralizer				5			RX	Switched to down hole hammer and button bit ROCK, dry, basic mesozoic intrusive varying from quartz diorite to gabbro; aphanitic to phaneritic; predominate crystals appear to be feldspar; pyroxenes, hornblende, & biotite; some epidote and serpentine in fractures
Bentonite/cement grout				15			GP	Ground mass up to 90% boulder and cobbles of uncertain size. Remaining matrix composed of tan to black sand with occasional silt (GP)
5-inch Schedule 40 PVC blank casing				20			RX	ROCK, basic mesozoic intrusive as above; seems to be fractured heavily based on discontinuous difficulty / ease in drilling. Presumably fractures due to close proximity to fault and/or extension when overburden removed
				25				



SURFACE ELEVATION: 5522.00 feet
TOTAL DEPTH: 182.0 feet
DATE DRILLED: 5-17-88

LOGGED BY: TJC
SUPERVISED BY: RHO
DIAMETER of BORING: 10"
WATER ENCOUNTERED AT: 150.0 Feet



WALKER LANDFILL
MONO COUNTY, CALIFORNIA
LOG OF MONITORING WELL
MW-2

PLATE
3.1.3

WELL CONSTRUCTION	CHEMICAL ANALYSES		BLOW COUNT	DEPTH (feet)	SAMPLE NUMBER	LITHOLOGY SYMBOL	U. S. C. S. DESIGNATION	SOIL DESCRIPTION		
	LABORATORY	FIELD								
 <p>7-inch Schedule 40 PVC blank casing</p> <p>Centalizer</p> <p>Bentonite/cement grout</p>				25						
					30					
					35					
					40				Same intrusive material previously describ	
				45						
				50						



WALKER LANDFILL
 MONO COUNTY, CALIFORNIA

LOG OF MONITORING WELL
 MW-2 (CONT.)

PLATE

3.1.3

WELL CONSTRUCTION	CHEMICAL ANALYSES		BLOW COUNT	DEPTH (feet)	SAMPLE NUMBER	LITHOLOGY SYMBOL	U.S.C.S. DESIGNATION	SOIL DESCRIPTION
	LABORATORY	FIELD						
Bentonite/ cement grout				85				Same intrusive material previously described
5-inch Schedule 40 PVC blank casing				90				At 92 ft. and below, periodically add water with foam
Bentonite seal				95				At 95 - 97 ft., fractured rock - zero recovery At 95 - 121 ft., difficult drilling, added foam
Sand pack				100				Same intrusive material previously described
Centralizer				105				At 106 ft., individual crystals to 1/4 inch in fractures, hydrothermal origin
5-inch Schedule 40 PVC Screen (0.02 slot)				110				



WALKER LANDFILL
MONO COUNTY, CALIFORNIA

LOG OF MONITORING WELL
MW-2 (CONT.)

PLAT
3.1.3

WELL CONSTRUCTION	CHEMICAL ANALYSES		BLOW COUNT	DEPTH (feet)	SAMPLE NUMBER	LITHOLOGY SYMBOL	U.S.C.S. DESIGNATION	SOIL DESCRIPTION
	LABORATORY	FIELD						
Sand pack 5-inch Schedule 40 PVC screen (0.02 slot)				115				Same intrusive material previously described
				120				
				125				
				130				Change staff from TJC to BON
				135				Same intrusive material previously described

KLEINFELDER

WALKER LANDFILL
MONO COUNTY, CALIFORNIA

PLATE
3.1.3

LOG OF MONITORING WELL

MW-2 (CONT.)

PROJECT NUMBER 30-1477-06 PAGE 5 OF 7 January 1989

WELL CONSTRUCTION	CHEMICAL ANALYSES		BLOW COUNT	DEPTH (feet)	SAMPLE NUMBER	LITHOLOGY SYMBOL	U.S.C.S. DESIGNATION	SOIL DESCRIPTION
	LABORATORY	FIELD						
Sand pack Centralizer 5-inch Schedule 40 PVC screen (0.02 slot)				140				Same intrusive material previously described
				145				
				150				First ground water encountered at 150 ft.
				155				Becoming highly fractured Poor recovery - difficult drilling conditions to 162 ft.
				160				Same intrusive material previously described
				165				Same intrusive material previously described

KLEINFELDER

WALKER LANDFILL
 MONO COUNTY, CALIFORNIA
LOG OF MONITORING WELL
MW-2 (CONT.)

PLATE
3.1.3

PROJECT NUMBER 30-1477-06 PAGE 6 OF 7 January 1989

WELL CONSTRUCTION	CHEMICAL ANALYSES		BLOW COUNT	DEPTH (feet)	SAMPLE NUMBER	LITHOLOGY SYMBOL	U.S.C.S. DESIGNATION	SOIL DESCRIPTION
	LABORATORY	FIELD						
<p>Above ground locking steel well cover</p> <p>4-inch Schedule 40 PVC blank casing</p> <p>Bentonite/cement grout</p>				0 5 10 15 20 25				<p>GRAVELLY SILTY SAND (SM), light brown, dry, fine to coarse sand, little angular cobbles moderately graded Switched over to downhole hammer and button bit, using very little water</p> <p>As above, primarily colluvial and alluvial material-becoming well graded, trace boulders</p> <p>Save large floaters of competent rock</p> <p>Cobbles and Boulders are comprised of gabbro, diorite and quartz with minor feldspar, pyroxenes and epidote crystals visible</p> <p>Gravelly silty sand, light brown, dry, occasional cobbles and boulders, angular</p>

SURFACE ELEVATION: 5532.9 feet
TOTAL DEPTH: 190.0 feet
DATE DRILLED: 6-1-88

LOGGED BY: JU
SUPERVISED BY: RHD
DIAMETER of BORING: 8.5
WATER ENCOUNTERED AT: 167.0 Feet



WALKER LANDFILL
MONO COUNTY, CALIFORNIA
LOG OF MONITORING WELL
MW-3

PLATE

3.1.7

WELL CONSTRUCTION	CHEMICAL ANALYSES		BLOW COUNT	DEPTH (feet)	NUMBER	LITHOLOGY SYMBOL	U.S.C.S. DESIGNATION	SOIL DESCRIPTION
	LABORATORY	FIELD						
4-inch Schedule 40 PVC blank casing				115				Silty sand, light brown, dry, occasional cobbles, moderately graded, fine to coarse sand
Bentonite/cement grout				120				
				125				
				130		RX		ROCK, gabbro dislocation Block or boulder, competent
				135		SM		SILTY SAND (SM), light brown, dry, some cobbles and gravels, moderately well graded

KLEINFELDER

WALKER LANDFILL
MONO COUNTY, CALIFORNIA

LOG OF MONITORING WELL

MW-3 (CONT.)

PLATE

3.1.4

PROJECT NUMBER 30-1477-06 PAGE 5 OF 7 January 1989

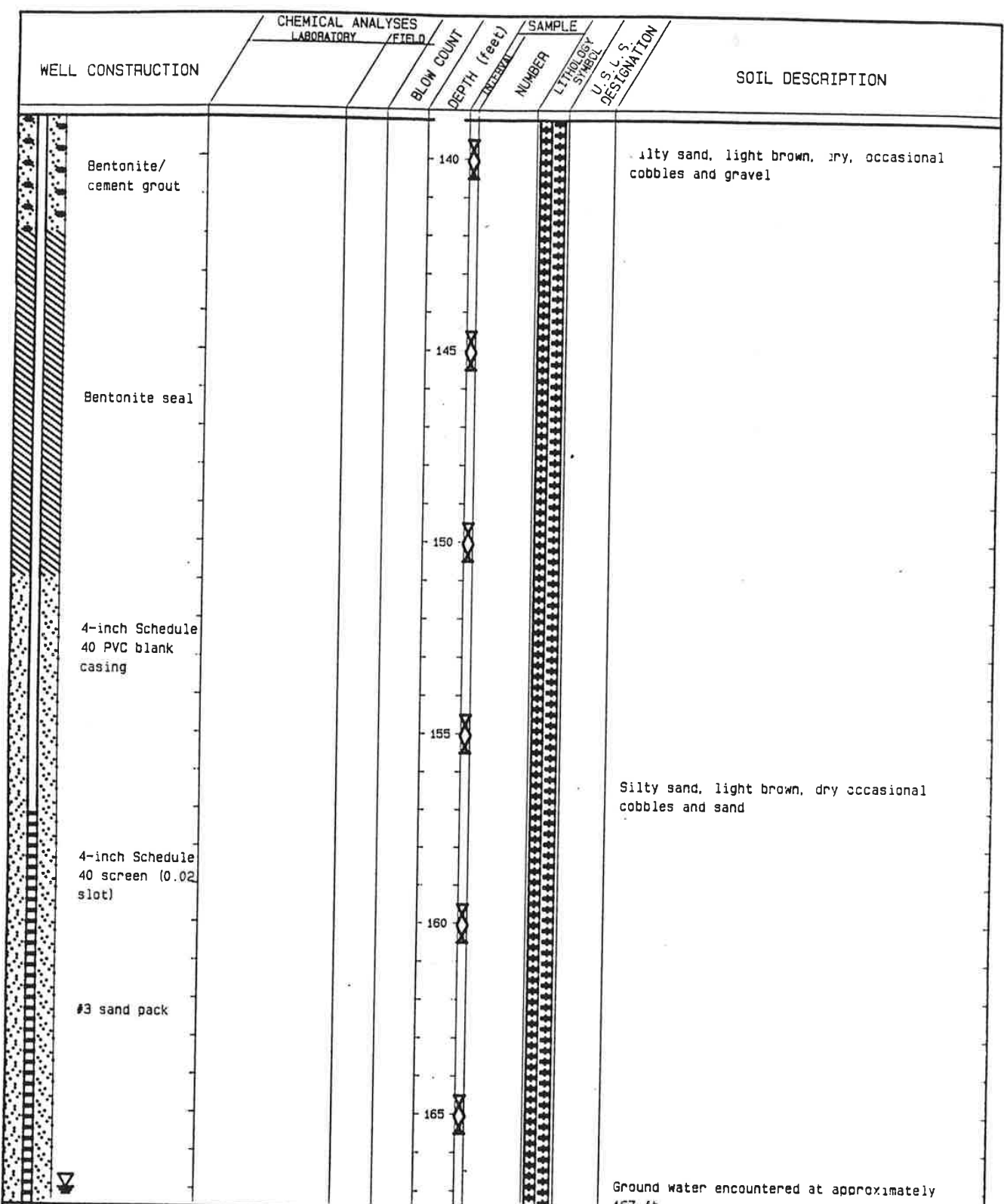

WALKER LANDFILL
 MONO COUNTY, CALIFORNIA
LOG OF MONITORING WELL
MW-3 (CONT.)

PLATE
3.1.4

WELL CONSTRUCTION	CHEMICAL ANALYSES		BLOW COUNT	DEPTH (feet)	SAMPLE NUMBER	LITHOLOGY SYMBOL	U.S.C.S. DESIGNATION	SOIL DESCRIPTION	
	LABORATORY	FIELD							
<p>#3 sand pack</p> <p>4-inch Schedule 40 PVC screen (0.02 slot)</p>				170				<p>GRAVELLY SILTY SAND (SM/GP), brown, moist, trace cobbles, fine to coarse sand, well graded</p> <p>At 186 ft., moist to damp</p> <p>Total depth of well 187 ft.</p> <p>Bottom of boring = 190 ft. Boring drilled using air only - no foam. 4-inch Schedule 40 PVC screen (0.02 slot) 157-187 ft., 4-inch Schedule 40 PVC blank casing 0-157 ft., #3 sand pack 151-187 ft., Bentonite seal 142-151 ft., Bentonite/cement grout 0-142 ft., centralizer placed on well. Boring drilled using an air percussion hammer. Steel locking well cover installed over top of well casing.</p>	
				175					
				180					
				185					
				190					
				195					



WALKER LANDFILL
 MONO COUNTY, CALIFORNIA
LOG OF MONITORING WELL
MW-3 (CONT.)

PLATE
 3.1.4