

CEQA Guidelines §15183 Environmental Analysis

—for—

**Colitas Farms Cannabis Cultivation
Mono County, California**

October 2019

Prepared by:

Mono County Community Development Department
Planning Division
Post Office Box 347
Mammoth Lakes, CA 93546

CEQA Guidelines §15183 Environmental Analysis

—for—

Colitas Farms Cannabis Cultivation Mono County, California

October 2019

LIST OF PREPARERS

RESOURCE CONCEPTS, INC.

340 N Minnesota St
Carson City, NV 89703
Contact Person: Lynn Zonge
(775) 883-1600

Mono County Planning Staff

Mono County Community Development Department
Planning Division
Post Office Box 347
Mammoth Lakes, CA 93546
Contact Person: Hailey Lang
(760) 932-5415

Project Sponsor

Colitas Farms
324 North River Lane
Walker, CA 96107

TABLE OF CONTENTS

I. INTRODUCTION 1

II. PROJECT INFORMATION..... 1

III. AGENCY JURISDICTION AND APPROVALS.....8

IV. PROJECT COMPLIANCE WITH SECTION 151838

V. ANALYSIS 8

VI. DISCUSSION OF RESPONSES TO CHECKLIST ITEMS 12

VII. DETERMINATION 29

VIII. REFERENCES..... 30

List of Photos

Photo 1. An example of the proposed barn structure 3

Photo 2 and 3. Examples of wooden gate and fencing to be used on site. 3

Photo 4. Looking to the northwest from the Project Area..... 7

Photo 5. Looking to the south facing the closest residential homes. 7

Attachments

- A. Location Maps
- B. Integrated Pest Management Plan
- C. Waste Management Plan
- D. Lahontan Regional Water Quality Control Board Letter
- E. Odor Mitigation Plan and Wind Rose Charts for Walker, California
- F. Cultural Resource Information

I. INTRODUCTION

The California Environmental Quality Act (CEQA) requires public agencies to consider and analyze the potential environmental effects of certain activities and establishes a process for determining whether the activity is subject to CEQA requirements. Activities are subject to CEQA if they (a) involve the exercise of discretionary powers, (b) have potential to impact the environment, and (c) meet the definition of a 'project,' and (d) are not categorically or statutorily exempt from CEQA.

CEQA Guideline §15183 provides a specific CEQA review process for qualifying projects that are consistent with a community plan or zoning. Under these regulations (reflected in California Public Resources Code (PRC) §21083.3 and CEQA Guidelines §15183), projects that are consistent with the development density of existing zoning, community plan or general plan policies for which an Environmental Impact Report (EIR) was certified shall be exempt from additional CEQA analysis except as may be necessary to determine whether there are project-specific significant effects that are peculiar to the project or site that would otherwise require additional CEQA review.

Mono County has existing land use, community plan and general plan policies for which an EIR was certified; including the Mono County General Plan, Final Environmental Impact Report (FEIR) certified in 2015 (SCH # 2014061029). This contains analysis of general plan policies for all required general plan elements and the zoning code governing land uses, which is integrated into Mono County's General Plan.

The Mono County Planning Division has prepared an Initial Study checklist to determine whether there are project-specific significant effects that are peculiar to the project or to the site. As mandated by the CEQA Guidelines Section 15183, this checklist identifies whether environmental effects of the project:

1. Are peculiar to the project or the parcel on which the project would be located;
2. Were not analyzed as significant effects in a prior EIR on the land use, general plan, or community plan, with which the project is consistent;
3. If environmental effects are identified as peculiar to the project and were not analyzed in a prior EIR, are there uniformly applied development policies or standards that would mitigate the environmental effects;
4. Are potentially significant off-site impacts and cumulative impacts which were not discussed in the prior EIR prepared for the General Plan, community plan, or land use; or
5. Are there previously identified significant effects which, because of substantial new information that was not known at the time the EIR was certified, are determined to have a more severe adverse impact than discussed in the prior EIR.

Further examination of environmental effects related to the project is limited to those items identified in the checklist as meeting one of the above criteria.

II. PROJECT INFORMATION

Project Title:	Colitas Farms Cannabis Cultivation
Lead Agency Name, Address with Contact Person and Phone #:	Mono County Community Development Department Planning Analyst II P.O. Box 347 Mammoth Lakes, CA 93546 Hailey Lang (760) 932-5415
Project Location:	Colitas Farms is located at 324 North River Lane in Walker, California
Plan Area:	Antelope Valley
Assessor Parcel Number (APN):	002-460-015-000

Description of Project

Colitas Farms is proposing a 20,000 square-foot (SF) commercial greenhouse cannabis cultivation operation. The project is located within a 19.7-acre parcel at 324 North River Lane (APN 002-460-015-000) that is owned by the project proponent. The General Plan designation of the parcel is Agriculture (AG) with a 10-acre parcel size minimum. The Location Map and Site Plan are provided in Attachment A.

A Mono County Use Permit and Operations Permit for cultivation, processing, and Type 6 manufacturing will be submitted to conduct operations. Obtaining the required California State permits to cultivate cannabis will be conditions of both permits.

The proposed project utilizes greenhouses to grow, process, and manufacture cannabis. The project facilities and ancillary items are listed below (see Attachment A):

- Two 10,000 square-foot greenhouses
- One immature plant greenhouse (30'x50' or 1,500 SF)
- One diffused light clone greenhouse (30'x50' or 1,500 SF)
- Two oil extraction, drying and processing sheds (12'x60' or 720 SF each)
- One 800 SF compost area
- Three waste storage containers (10'x5' or 150 SF each)
- Two cannabis storage containers (8'x40' or 320 SF each)
- One barn (totaling 2,592 SF) with upstairs apartment (appx 1,000 SF) with adjacent parking area
- One accessory dwelling unit (13'x52' or 693 SF) with adjacent parking area
- Two diesel generators for backup and emergency supply
- One parking area for 10 vehicles (50'x58' or 2,908 SF)
- Four loading zone areas (800 SF each)
- Four 2,500-gallon water tanks
- One 10,000-gallon water tank
- Two propane tanks (250 GAL and 1,000 GAL)
- One well house (10'x10', or 100 SF)
- Front gate and fencing for security
- Underground utilities
- Trees around the property perimeter for visual aesthetics (Leyland Cypress and Sambuca Black Lace)
- One-way road with two access points

In addition to growing cannabis, the farm will grow lavender which includes the following items:

- Two lavender cultivation areas (4,356 SF and 4,560 SF) and lavender oil extraction
- One honey box

The main greenhouse will be a pipe frame structure with a durable polycarbonate cover. Ultimately, up to 20,000 SF of mature plant canopy will be grown in the main greenhouse and second green house (shown on site plan as items 6 and 9) and up to 10,000 square feet will be grown in the main greenhouse and up to an additional 10,000 square feet will be grown in the second greenhouse. Plants will be watered by hand and with drip irrigation.

The greenhouse, immature plant nursery, and the diffused light clone greenhouse will use a nonaqueous odor control chemical delivery system as means of primary odor control via NCM Environmental Solutions. In addition to primary odor control, misting fans will treat all exhaust vapors being released from greenhouse vents. The composting area will be covered and have an external misting system for odor control (see Attachment E).

The oil extraction, drying, and processing sheds will be separate from the main greenhouse (see Site Plan in Attachment A) and will be primarily used to process harvested plant material. Oil extraction will occur in approximately 192 square feet in each of the sheds. Both buildings will have charcoal filter systems to assist with odor mitigation.

An apartment barn (approximately 1,000 SF of living space with a total SF of 2,592) will be located on site for employee housing. The apartment barn will be placed east of the main greenhouse (see Attachment A). A manufactured home (693 square feet) for additional employee housing will also be placed on-site at a later date and will replace the dilapidated manufactured home currently on site. There will be a gravel parking area adjacent to the apartment barn with two parking spaces and a gravel parking area directly west of the manufactured home with two parking spaces.

The lower level of the apartment barn and two storage containers will be used to store cultivation equipment. No cultivation will take place in any of the storage containers or the apartment barn.



Photo 1. An example of the proposed barn structure

The fence and gates, including the main access wooden gate, will be maintained as a part of the site security. A security plan, which is confidential as provided by state law, will meet California Department of Food and Agriculture (CDFA) requirements and be approved by the Mono County Sherriff.



Photo 2 and 3. Examples of wooden gate and fencing to be used on site.

Up to four full-time employees will initially be employed on the property five days a week. During harvest there will be up to an additional six employees with a maximum of 10 at any one time. Harvest will occur four times per year and span two weeks each harvest. Employee vehicles will be accommodated by an on-site parking area with ten spaces.

Parking for the non-residential employees will be located near the front gate next to the lavender grow area in the southeast corner of the property and there are also four separate areas throughout the property designated for loading. Three turnouts on the one-way road would accommodate access and emergency vehicle turnaround. Turnarounds are required on driveways and dead-end roads. The minimum turning radius for a turnaround shall be 40 feet, not including parking. If a hammerhead "T" is used instead, the top of the "T" shall be a minimum of 60 feet in length. Turnouts shall be a minimum of 12 feet wide and 30 feet long with a minimum 25-foot taper on each end.

Colitas Farms will also produce lavender and honey to be marketed to the general public. Lavender will be cultivated outdoors along the property entrance and border with North River Lane. The lavender will be a secondary crop for the farm and will also provide aesthetic odor value. In addition to the lavender crop, the operation will be surrounded by trees (Leyland Cypress and Sambuca Black Lace) on the east, west, and south sides as a visual screen. The north side of the operation will abut current riparian vegetation along the irrigation ditch (see Attachment A).



Photo 4 and 5. Examples of Sambuca Black Lace and Leyland Cypress.

Pesticides, fungicides, rodenticides, and other plant protectants that are intended to be used are outlined in the Integrated Pest Management Plan (Attachment B). These materials will be stored in the storage containers near the waste storage and composting area. Waste management operations are detailed in the Waste Management Plan (Attachment C).

Nothing will be sold on site. There will be no public access to the property.

Physical Characteristics of the Property

- The property is situated at about 5,430 feet in elevation near the West Walker River, is relatively flat with a gentle slope to the southeast.
- The project area is dominated by sagebrush, except for the three irrigation ditches that cross the property. These are dominated by riparian shrub species.
- Currently, a dilapidated mobile home and outbuildings and pump house are located on the parcel.
- Photos 5 and 6 provide general overview of the existing conditions at the project area.

Surrounding Land Use Designations

- Directly adjacent land use designations to the project area are agricultural, extending out to the north, east, and west, and Estate Residential to the south. The nearest residence is approximately 343 feet away from the cultivation area.
- The Land Use Designations (LUDs) adjacent to APN 002-460-015-000 are:

East:	Private Land – Agriculture (AG)
West:	Private Land – Agriculture (AG)
South:	Private Land – Estate Residential (ER)
North:	Private Land – Agriculture (AG)

Access

- Access to the existing premise is a paved road extending from North River Lane. A one-way road will be constructed to Chapter 22 standards and provide for traffic circulation on the parcel. There will be two lockable access gates along North River Lane at both access points. The gates will also add to the aesthetic value of the property with its decorative, wooden features.

Utilities

- The existing utilities for the project area are as follows:

Water Supply:	Private Well
Sewer:	Private Septic System
Garbage:	D&S Waste Removal Inc.
Electricity:	Liberty Energy

The electricity will be provided to the property using the existing overhead utility line and the underground lines will be extended from the overhead line.

The cannabis operation will be closed to the public.

One hanging sign is proposed and will be located at the front of the property over the main entry gate. The sign will be ranch style and will be made of wood and copper. The sign will read, "Colitas Farms" with the company logo of a fox. It will be no larger than 10 square feet in size and will have a total clearance of 8-10 feet. The example of the sign is shown in Photo 5 and the logo is shown in Photo 6.



Photo 5. Example of signage.



Photo 6. Company logo.



Photo 7. Looking to the northwest from the Project Area.



Photo 8. Looking to the south facing the closest residential homes.

III. AGENCY JURISDICTION AND APPROVALS

Mono County is lead agency for this CEQA §15183 review. Mono County is responsible for the necessary Use Permit and Operations Permit.

Licensing and regulating commercial cannabis to ensure public safety and environmental protection is the purview of the State of California. The state prepared a Programmatic Environmental Impact Report (PEIR) to provide a transparent, and comprehensive evaluation of the anticipated regulations and the activities that would occur in compliance with the regulations. Under this program, cannabis activities can occur in a combination of urban, rural, natural, and agricultural settings in the State. Individual projects, however, must be covered under a CEQA analysis by the local jurisdiction.

The Lahontan Regional Water Quality Control Board (LRWQCB) is responsible for protection of water resources and approval from this board is required. A letter from the LRWQCB has been obtained and is provided in Attachment D.

Government Code § 65300 requires each county to “adopt a comprehensive long-term general plan for the physical development of the county.” Mono County is unique in that the General Plan and Zoning Code have been combined into one document. There is an area plan for Antelope Valley.

The AG Land Use Designation (LUD) permits cannabis cultivation subject to a use permit and in compliance with Chapter 13 of the General Plan, and a Cannabis Operation Permit pursuant to Mono County Code Chapter 5.60.

IV. PROJECT COMPLIANCE WITH SECTION 15183

The project site is designated AG in the Mono County General Plan. The purpose of the AG designation is “*To preserve and encourage agricultural uses, to protect agricultural uses from encroachment from urban uses, and to provide for the orderly growth of activities related to agriculture*” and provides outright for non-cannabis crop cultivation and related processing activities. The proposed project is consistent with the development density of existing zoning and local planning policies for the Antelope Valley which are aimed at preserving agriculture over residential development. Therefore, cannabis cultivation, processing, and Type 6 manufacturing are consistent with the development density of existing zoning and consistent with General Plan and Area Plan policies.

V. ANALYSIS

The following CEQA section 15183 is based on Public Resources Code Section 21083.3 and Section 15183 of the CEQA Guidelines. The checklist assesses potential environmental impacts to determine whether they meet requirements for assessment under Section 15183; i.e.,

1. Are potential impacts peculiar to the project or parcel?
2. Were the impacts addressed in a previously certified EIR?
3. If an impact is peculiar to the project and was not addressed in a prior EIR, are there uniformly applied development policies or standards that would mitigate the impact?
4. Are there potentially significant cumulative or off-site impacts that were not discussed in the prior EIR?
5. Is there substantial new information to show that a potential impact would be more significant than previously described?

	Issues & Supporting Information Sources	Impact potentially peculiar to the project or parcel?	Was the impact addressed in the prior EIR?	If peculiar and not addressed, are there uniformly applied development policies or standards that would mitigate?	Potentially significant cumulative or off-site impacts not discussed in the prior EIR?	Substantial new information showing impact more significant than previously described?
1) Land Use and Planning						
a)	Conflict with general plan designation or zoning?	No	Yes	N/A	No	No
b)	Conflict with applicable environmental plans or policies adopted by agencies with jurisdiction over the project?	No	Yes	N/A	No	No
c)	Be incompatible with existing land use in the vicinity?	No	Yes	N/A	No	No
d)	Affect agricultural resources or operations (e.g., impacts to soils or farmlands, or impacts from incompatible land uses)?	No	Yes	N/A	No	No
e)	Disrupt or divide the physical arrangement of an established community (including a low-income or minority community)?	No	Yes	N/A	No	No
2) Population and Housing						
a)	Cumulatively exceed official regional or local population projections?	No	Yes	N/A	No	No
b)	Induce substantial growth in an area either directly or indirectly (e.g., through projects in an undeveloped area or extension of major infrastructure)?	No	Yes	N/A	No	No
c)	Displace existing housing, especially affordable housing?	No	Yes	N/A	No	No
3) Geology and Soils						
a)	Fault rupture?	No	Yes	N/A	No	No
b)	Seismic ground shaking?	No	Yes	N/A	No	No
c)	Seismic ground failure, including liquefaction?	No	Yes	N/A	No	No
d)	Seiche, tsunami, or volcanic hazard?	No	Yes	N/A	No	No
e)	Landslides or mudflows?	No	Yes	N/A	No	No
f)	Erosion, changes in topography or unstable soil conditions from excavation, grading, or fill?	No	Yes	N/A	No	No
g)	Subsidence of the land?	No	Yes	N/A	No	No
h)	Expansive soils?	No	Yes	N/A	No	No
i)	Unique geologic or physical features?	No	Yes	N/A	No	No
4) Water Resources						
a)	Changes in absorption rates, drainage patterns, or the rate and amount of surface runoff?	No	Yes	N/A	No	No
b)	Exposure of people or property to water related hazards such as flooding?	No	Yes	Yes	No	No

CEQA §15183 Environmental Analysis

	Issues & Supporting Information Sources	Impact potentially peculiar to the project or parcel?	Was the impact addressed in the prior EIR?	If peculiar and not addressed, are there uniformly applied development policies or standards that would mitigate?	Potentially significant cumulative or off-site impacts not discussed in the prior EIR?	Substantial new information showing impact more significant than previously described?
c)	Discharge into surface waters or other alteration of surface water quality (e.g., temperature, dissolved oxygen, or turbidity)?	No	Yes	N/A	No	No
d)	Changes in the amount of surface water in any water body?	No	Yes	N/A	No	No
e)	Changes in currents, or the course or direction of water movements?	No	Yes	N/A	No	No
f)	Change in the quantity of groundwater, either through direct additions or withdrawals, or through interception of an aquifer by cuts or excavations or through substantial loss of groundwater recharge capability?	No	Yes	N/A	No	No
g)	Altered direction or rate of flow of groundwater?	No	Yes	N/A	No	No
h)	Impacts to groundwater quality?	No	Yes	N/A	No	No
i)	Substantial reduction in the amount of groundwater otherwise available for public water supplies?	No	Yes	N/A	No	No
5) Air Quality						
a)	Violate any air quality standard or contribute to an existing or projected air quality violation?	No	Yes	N/A	No	No
b)	Expose sensitive receptors to pollutants?	No	Yes	N/A	No	No
c)	Alter air movement, moisture, or temperature, or cause any change in climate?	No	Yes	N/A	No	No
d)	Create objectionable odors?	Yes	Yes	N/A	No	No
6) Transportation/Circulation						
a)	Increased vehicle trips or traffic congestion?	No	Yes	N/A	No	No
b)	Hazards to safety from design features (e.g., sharp curves or dangerous intersections) or incompatible uses (e.g., farm equipment)?	No	Yes	N/A	No	No
c)	Inadequate emergency access or access to nearby uses?	No	Yes	N/A	No	No
d)	Insufficient parking capacity on-site or off-site?	No	Yes	N/A	No	No
e)	Hazards or barriers for pedestrians or bicyclists?	No	Yes	N/A	No	No
f)	Conflicts with adopted policies supporting alternative transportation (e.g., bus turnouts, bicycle racks)?	No	Yes	N/A	No	No
g)	Rail, waterborne or air traffic impacts?	No	Yes	N/A	No	No
7) Biological Resources						
a)	Endangered, threatened, or rare species or their habitats (including but not limited to: plants, fish, insects, animals, and birds)?	No	Yes	N/A	No	No

	Issues & Supporting Information Sources	Impact potentially peculiar to the project or parcel?	Was the impact addressed in the prior EIR?	If peculiar and not addressed, are there uniformly applied development policies or standards that would mitigate?	Potentially significant cumulative or off-site impacts not discussed in the prior EIR?	Substantial new information showing impact more significant than previously described?
b)	Locally designated species (e.g., heritage trees)?	No	Yes	N/A	No	No
c)	Locally designated natural communities (e.g., oak forest, coastal habitat, etc.)?	No	Yes	N/A	No	No
d)	Wetland habitat (e.g., marsh, riparian and vernal pool)?	No	Yes	N/A	No	No
e)	Wildlife dispersal or migration corridors?	No	Yes	N/A	No	No
8) Energy and Mineral Resources						
a)	Conflict with adopted energy conservation plans?	No	Yes	N/A	No	No
b)	Use non-renewable resources in a wasteful and inefficient manner?	No	Yes	N/A	No	No
c)	Result in the loss of availability of a known mineral resource that would be of future value to the region and the residents of the state?	No	Yes	N/A	No	No
9) Hazards						
a)	A risk or accidental explosion or release of hazardous substances (including but not limited to: oil, pesticides, chemicals, or radiation)?	No	Yes	N/A	No	No
b)	Possible interference with an emergency response plan or emergency evacuation plan?	No	Yes	N/A	No	No
c)	The creation of any health hazard or potential health hazard?	No	Yes	N/A	No	No
d)	Exposure of people to existing sources for potential health hazards?	No	Yes	N/A	No	No
e)	Increased fire hazard in areas with flammable brush, grass, or trees?	No	Yes	N/A	No	No
10) Noise						
a)	Increases in existing noise levels?	No	Yes	N/A	No	No
b)	Exposure of people to severe noise levels?	No	Yes	N/A	No	No
11) Public Services						
a)	Fire protection?	No	Yes	N/A	No	No
b)	Police protection?	No	Yes	N/A	No	No
c)	Schools?	No	Yes	N/A	No	No
d)	Parks or recreational facilities?	No	Yes	N/A	No	No
e)	Maintenance of public facilities, including roads?	No	Yes	N/A	No	No
f)	Other governmental services?	No	Yes	N/A	No	No
12) Utilities and Service Systems						
a)	Power or natural gas?	No	Yes	N/A	No	No
b)	Communications systems?	No	Yes	N/A	No	No

	Issues & Supporting Information Sources	Impact potentially peculiar to the project or parcel?	Was the impact addressed in the prior EIR?	If peculiar and not addressed, are there uniformly applied development policies or standards that would mitigate?	Potentially significant cumulative or off-site impacts not discussed in the prior EIR?	Substantial new information showing impact more significant than previously described?
c)	Local or regional water treatment or distribution facilities?	No	Yes	N/A	No	No
d)	Sewer or septic tanks?	No	Yes	N/A	No	No
e)	Storm water drainage?	No	Yes	N/A	No	No
f)	Solid waste disposal?	No	Yes	N/A	No	No
g)	Local or regional water supplies?	No	Yes	N/A	No	No
13) Aesthetics						
a)	Affect a scenic vista or scenic highway?	No	Yes	N/A	No	No
b)	Substantially degrade the existing visual character or quality of the site and its surroundings?	No	Yes	N/A	No	No
c)	Create light or glare?	No	Yes	N/A	No	No
14) Cultural Resources						
a)	Disturb paleontological, archaeological, or historical resources?	No	Yes	Yes	No	No
b)	Restrict existing religious or sacred uses within the potential impact area?	No	Yes	N/A	No	No
15) Recreation						
a)	Increase the demand for neighborhood or regional parks or other recreational facilities?	No	Yes	N/A	No	No
b)	Affect existing recreational opportunities?	No	Yes	N/A	No	No

VI. DISCUSSION OF RESPONSES TO CHECKLIST ITEMS

Introduction

Public Resources Code Section 21083.3 and CEQA Guidelines Section 15183 mandate that when a parcel has been zoned to accommodate a particular land use and density, and has an EIR that was certified for the zoning or planning action, then subsequent environmental review of a project consistent with that prior action shall be limited to those effects from the project that are peculiar to the parcel or the site unless substantial new information indicates that the effect will be more significant than previously described or there are potentially significant off-site or cumulative impacts not discussed in the prior EIR.

In determining whether an effect is peculiar to the project or the parcel, Public Resources Code Section 21083.3 and the CEQA Guidelines Section 15183 state that an effect *shall not be considered peculiar to the project if it can be substantially mitigated by uniformly applied development policies or standards that have previously been adopted by the County with a finding that the policies or standards will substantially mitigate that environmental effect when applied to future projects* (unless substantial new information shows that the policies or standards will not substantially mitigate the environmental effect).

Potential effects peculiar to this project will be limited since the project is being developed in an agricultural area. Most of the effects of the project associated with ground disturbance for agricultural structures and crops were identified in the EIR certified by the County in conjunction with the adoption and update of the Mono County General Plan and are not unique or peculiar to the proposed project.

The area is suitable for the proposed agricultural use, and utilities with enough capacity for the project are in place or can be extended. The potential environmental effects of the project are in conformance with the requirements of the CEQA Guidelines Section 15183.

1) Land Use and Planning

Compliance with General Plan, Area Plan, and Land Use Designation

The Land Use Element in the Mono County General Plan serves as a foundation for all land use decisions and contains policies, land use designations and “zoning,” and land development regulations to regulate development activities. The project site is in Antelope Valley on land that is designated as Agriculture-10 (AG-10).

Agricultural uses such as row crops, orchards, sheds and warehouses, processing, etc.; farm labor housing and accessory dwelling units; equipment; and related agricultural activities are permitted outright. The project is consistent with the development density of existing zoning. In addition, the project is consistent with policies contained in the General Plan and area plan, and the development standards in Chapter 13.

A conditional use permit is required for the commercial cannabis component of the project, which is permissible in AG land use designations in recognition that cannabis projects can have unique impacts peculiar to these projects. These impacts, such as odor and visuals, among others, are analyzed separately in this document and do not affect the determination of land use consistency.

The project is not located within 600’ of any of the facilities listed in Action 1.L.3.a., including schools, parks, playgrounds, libraries, or community centers. The nearest schools are Antelope Valley Elementary School and Coleville High School, both located four miles to the northwest in Coleville, CA.

The project is consistent with the General Plan, including the following goals and policies:

Mono County General Plan, Land Use Element

- Policy 1.G.1. Protect lands currently in agricultural production.
Action 1.G.1.a. Designate large parcels in agricultural use as “Agriculture,” and streamline redesignations for agricultural purposes by processing a discretionary permit (when applicable) concurrently with the land use designation change.
 - Policy 1.L.3. Avoid, reduce, and prevent potential issues specific to commercial cannabis activities that may adversely affect communities
 - Policy 1.L.4. In recognition of the potential economic benefits of this new industry, encourage the responsible establishment and operation of commercial cannabis activities.
- GOAL 2. Develop a more diverse and sustainable year-round economy by strengthening select economic sectors and by pursuing business retention, expansion, and attraction in Mono County.
- Policy 2.A.1. Integrate the adopted Economic Development Strategic Plan into General Plan policies.

Planning Area Land Use Policies: Antelope Valley

- Policy 4.B.1. Maintain and enhance scenic resources in the Antelope Valley.
- Action 4.B.1.a. In order to protect and enhance important scenic resources and scenic highway corridors, designate such areas in the Antelope Valley for Open Space, Agriculture, or Resource Management.
Action 4.B.1.d. Conserve scenic corridors by maintaining and expanding large-lot land uses.
- Policy 4.B.2. Preserve the agricultural lands and natural resource lands in the Antelope Valley.
- Policy 4.B.6. Preserve rural character of lands within the Antelope Valley.

- Action 4.B.6.a. Allow the storage of heavy equipment on parcels greater than five acres in the Antelope Valley for personal on-site use or community benefit.
- Objective 4.D. Maintain and enhance the local economy.
- Policy 4.D.1. Incubate home businesses.

Mono County General Plan, Conservation/Open Space Element

Agriculture, Grazing and Timber

- GOAL 5. Preserve and protect agricultural and grazing lands in order to promote both the economic and open-space values of those lands.
- Policy 5.B.1. Limit land uses within viable agricultural areas to those that are compatible with agricultural uses.
- Action 5.B.1.a. Maintain, in those agricultural land use categories where small parcels may be permitted, the largest land area for agricultural use. Limit the number of clustered lots in any one area to avoid the potential conflicts associated with residential intrusion.
- Action 5.B.2.a. Facilitate agricultural production by permitting limited agricultural support service uses that support local agricultural activities and are not harmful to the long-term agricultural use in the area.

Determination

The project is consistent with the surrounding land uses of the proposed project.

- The land use and planning impacts of the proposed agricultural cultivation were analyzed in the FEIRs certified in conjunction with the adoption of the Mono County General Plan.
- This parcel is no different than other agricultural parcels in the surrounding area; there is nothing unusual about the proposed project that would change or in any way affect the severity of these impacts. The impacts are not peculiar to the parcel or the project.
- There is no new substantial information indicating that the land use and planning impacts of the project will be more severe than described in the FEIR.
- There are no cumulative or off-site land use and planning impacts from the proposed project that were not addressed in the prior FEIR.

2) Population and Housing

The General Plan Land Use Element density for parcel APN 002-460-015-000, located in Antelope Valley, is one unit per lot plus an accessory building and farm labor housing. The proposed project would construct an apartment barn structure that will include farm labor housing for one full-time employee and replace the existing dilapidated mobile home with a manufactured home for additional farm labor housing at a later date. Farm labor housing is a permitted land use for agricultural LUDs. The apartment barn and manufactured home would use electricity provided via underground conduit from the overhead line along North River Lane. The existing on-site well and septic system is sufficient for the farm labor housing. The on-site employees are not expected to have demands for utilities exceeding those for a standard home plus an accessory dwelling unit.

There will be one full-time employee living on the property and up to three full-time employees working on the property about five days per week. During harvest there will be up to an additional 6 employees for a total of 10 at any one time. Harvest will occur four times per year and span two weeks each harvest. All but the one full-time employee living on site will commute to the property although eventually more employees may live on site in the manufactured home. All housing will comply with Mono County General Plan regulations, Mono County Building Division, and the California Building Code. Colitas Farms employees will not result in substantial population growth compared to the population of the valley and on-site housing meets or exceeds the currently suspended Housing Mitigation Ordinance (HMO).

The project is consistent with the General Plan in the following policies and actions:

Mono County General Plan, Land Use Element

- Policy 1.D.4. Require future development projects with the potential for significant housing impacts to provide a fair share of affordable and workforce housing units.
- Action 1.D.4.a. The County shall work with proponents during the specific plan or planning permit processes to ensure compliance.
- Action 1.D.4.b. The County shall monitor the employee housing programs to ensure compliance and adjust employee housing policies when necessary.

Determination

- The population and housing impacts of the proposed agriculture cultivation project were analyzed in the FEIR certified in conjunction with the adoption of the Mono County General Plan.
- This parcel is no different than other parcels in the surrounding area; there is nothing unusual about the proposed project that would change or in any way affect the severity of these impacts. The impacts are not peculiar to the parcel or the project.
- The project reduces impacts due to the voluntary provision of farm labor housing, which is not required of AG operations by the General Plan.
- There is no new substantial information indicating that the population and housing impacts of the project will be more severe than described in the FEIR.
- There are no cumulative or off-site population and housing impacts from the proposed project that were not addressed in the FEIR.

3) Geology and Soils

Mono County is designated as a Seismic Zone 4, the zone of greatest hazard defined in the Uniform Building Code. Consequently, new construction in the County must comply with stringent engineering and construction requirements (Government Code §8875). All buildings proposed for construction will be permitted and built to meet County Code.

The parcel property south of the irrigation drainages where the project is proposed overlies Mottsville loamy coarse sand, 4 to 15 percent slopes. This soil unit is farmland of statewide importance. The soil is excessively drained and is not hydric.

The Mono County General Plan and Land Development Regulations and the Mono County Regional Transportation Plan contain policies and standards concerning geology that have been applied to this project; as follows:

Mono County General Plan, Land Use Element

- OBJECTIVE 1.H. Prevent the exposure of people and property to unreasonable risks by limiting development on hazardous lands.

Determination

- The geologic impacts of the proposed agricultural cultivation project were analyzed in the FEIRs certified in conjunction with the adoption of the Mono County General Plan.
- This parcel is no different than other parcels in the surrounding area; there is nothing unusual about the proposed project that would change or in any way affect the severity of these impacts. The impacts are not peculiar to the parcel or the project.
- There is no new substantial information indicating that geologic impacts of the project will be more severe than described in the FEIR.
- There are no cumulative or off-site geologic impacts from the proposed project that were not addressed in the FEIR.

4) Water Resources

The existing water resources on the property are sufficient to serve the proposed use. The existing well will serve farm labor housing and the greenhouses for cultivation purposes. Water for domestic use and the irrigation system will be tested and plumbed in compliance with Mono County regulations.

The proposed 20,000 SF cannabis cultivation would draw approximately 3,200 gallons/day at full build out. This usage equates to 1,160,700 gallons or 3.56 acre-feet of water annually (Caulkins, 2010). Well water will be used for the cannabis production. Irrigation to the cannabis crop will be precise, using a computer automated drip system. The water usage would be in accordance with the groundwater rights owned by the property.

The tree shelterbelt will consist of about 200 plants of Sambuca Black Lace and Leyland Cypress. These plants use approximately two gallons of water per plant per week for the first five years of growth, or 20,000 gallons per year. After the fifth year the property line trees will require water twice per month in the spring and once per month in the summer, reducing the water usage to 7,500 gallons per year.

The lavender is a drought resistant plant and will require minimal water the first year and then may be watered once or twice a year, depending on rainfall. They thrive in environments with 12 inches of rain per year. Walker, California receives on average 11 inches of precipitation per year, mostly during the winter months (www.usa.com/walker-ca-weather.htm). Worst case scenario, the lavender would require about one acre-foot of water (325,850 gallons) in the event of a drought.

The lavender crop and tree shelterbelt will be irrigated independently from cannabis with surface water from the Lone Company Ditch irrigation system running through the property. The total annual surface water usage will be about 1.1 acre-feet. Water from the canal will be pumped into four 2,500-gallon tanks in compliance with applicable California State water law and piped to irrigation lines. According to the property deed and The Walker River Water Decree, the property is allowed to pump 0.32 cubic feet of water per second (cfs) during the non-forbearance period from the irrigation ditches. This equates to 8,580 gallons per hour. This quantity, together with the storage tanks for use during the forbearance period, would provide enough water for the trees and lavender and would be in accordance with the surface water rights owned by the property.

The total combined water usage for the cannabis, trees and lavender will be about 4.6 acre-feet per year for an estimated 1.8 acres of crops. Typically, alfalfa or other hay crops in Antelope Valley require about four acre-feet of water per acre per year (1,303,000 gal), or 7.24 acre-feet/1.8 acres. The property is 19.7 acres, half of which is on a soil of statewide importance for farming and could support many acres of alfalfa. Therefore, water usage is less than a typical outright permitted agricultural use and the impacts are not peculiar to the project.

Water usage for agriculture was analyzed in the 2015 EIR and is not peculiar to the project. The groundwater basin is not subject to the State of California Sustainable Groundwater Management Act of 2014 because it is in a very low priority basin (<https://water.ca.gov/Programs/Groundwater-Management/Basin-Prioritization>). Groundwater withdrawal is not limited. The State Water Resources Control Board will monitor water usage for this proposed project. Regulations are set forth in the cannabis cultivation policy (Attachment A, Section 2, #99). Cannabis cultivators must maintain daily water use records for five years.

A letter from the LRWQCB states that the site plans comply with requirements of the General Waste Discharge Requirements and Waiver of Waste Discharge Requirements for Discharges of Waste Associated with Cannabis Cultivation Activities WQ 2017-0023-DWQ (Attachment D).

CDFA oversees licensee compliance of pesticides and fertilizers through the inspection and enforcement methods contained in the proposed regulations from reports from the County Agricultural Commissioner and other agencies. The Inyo and Mono Counties Agricultural Commissioner's Office conducts inspections roughly every year depending on the products being used (Nathan Reade, Agricultural Commissioner, Personal Comm. 11-29-2018). Pesticides,

fungicides, rodenticides, and other plant protectants that are intended to be used are outlined in the Integrated Pest Management Plan (Attachment B).

Lastly, the California Department of Water Resources has an adopted ordinance known as the Model Water Efficient Landscape Ordinance (MWELO). MWELO increases water efficiency standards for new and retrofitted landscapes through encouraging the use of more efficient irrigation systems, graywater usage, onsite storm water capture, and by limiting the portion of landscapes that can be covered in turf. This ordinance applies to all new landscape projects equal to or greater than 500 square feet requiring a building or landscape permit, plan check, or design review. Proposed landscaping for this project exceeds 500 square feet and therefore will need to comply with requirements of MWELO.

The Mono County General Plan and Land Development Regulations and the Mono County Regional Transportation Plan contain policies and standards concerning water resources that have been applied to this project as follows:

Mono County General Plan, Conservation/Open Space Element

Biological Resources

- Policy 2.A.9. Maintain water quality for fishery habitat by enforcing the policies contained in the Water Quality and Agriculture / Grazing / Timber sections of the Conservation/Open Space Element.

Water Resources and Water Quality

- Goal 4: Protect the quality of surface and groundwater resources to meet existing and future domestic, agricultural, recreational, and natural resource needs in Mono County.
- Policy 4.A.4. Establish buffer zones where recharge occurs, including adjacent to surface waters, wetlands, and riparian areas.
- Policy 4.B.5. Use of fertilizer, pesticide, and other chemicals on vegetation or soil in recharge zones should be minimized.
- Action 4.B.5.a. Work with the County Agricultural Commissioner and the Natural Resources Conservation Service to institute controls to protect water quality.
- Action 4.B.5.b. Work with the County Agricultural Commissioner and the Natural Resources Conservation Service to promote effective and minimal use of chemicals in landscaping and agriculture.
- General Plan 04.120.F.b. Any proposed structure, including associated impervious surfaces, shall be located a minimum of 30 feet from the top of the bank.

Determination

- The water resources impact of the proposed agricultural cultivation project was analyzed in the FEIR certified in conjunction with the adoption of the Mono County General Plan.
- This parcel is no different than other parcels in the surrounding area; there is nothing unusual about the proposed project that would change or in any way affect the severity of these impacts. The impacts are not peculiar to the parcel or the project.
- There is no new substantial information indicating that the impacts of the project on water resources will be more severe than described in the FEIR.
- There are no cumulative or off-site water resources impacts from the proposed project that were not addressed in the FEIR.

5) Air Quality

Proposed project operations will not violate any air quality standard or contribute substantially to an existing or projected air quality violation. All plants will be cultivated and processed inside greenhouses and processing buildings. Electrical power will be provided by Liberty Utility by using the existing overhead utility line and the underground lines will be extended from the overhead line.

As discussed in the General Plan EIR, Cal Recycle has conducted studies to identify odor sources associated with composting and has found that organic materials (used in composting) inherently generate a wide range and variety of odors resulting from the volatility of chemical compounds (whereby the compound is converted to a gas and enters the atmosphere). The character and strength of odors are highly subjective; sensitivity to an odor is greatly influenced by personal experience, gender, psychology, and social factors.

The cannabis odorous compounds are a family of terpenoids. The exact odor causing compounds vary by strain/species of the plant. Typically, moderate cannabis odors start to appear between week 4 to 6 and strong odors appear during weeks 7 to 9. The intensity of the odor to the receptor varies by the quantity of odors released, local wind speed and direction, atmospheric stability or inversion height, area topography and receptor's distance from the odor source.

Many rural counties in California have tended to analyze cannabis-related odor on a project-specific basis. Each project has a unique set of conditions. The nearest receptor to this proposed project is a residence (APN 002-310-032-000) that is 277 feet south of the proposed clone greenhouse and 321 feet south of the main greenhouse. The composting area is 474 feet from the nearest residence.

Because of this proximity to receptors, Colitas Farms is proposing several methods for odor control. A high-pressure mister/fogger by NCM Environmental Solutions will be installed on all ventilation systems at the mature plant greenhouses, the immature plant greenhouse, and the defused light greenhouse. The compost area will also be equipped with the same high-pressure fogging system as the greenhouses. The high-pressure mister/fogger system disperses an odor-neutralizing product that traps airborne odors and biodegrades unpleasant smells.

The NCM mister/fogger neutralizer has two active parts to neutralize odors, including fragrance and Metazene®. Metazene® is an odor neutralizing compound that directly interacts with odors. Metazene® reacts with the highly volatile aromatic compounds in cannabis to form a complex ion that acts like a net to surround and envelope the odor. This complex ion becomes 'heavy' and less volatile resulting in the neutralization of the odor. The fragrance is an odor masker. It is made up of various essential oils and aroma chemicals as well as some solvents to increase tenacity and longevity. The odor control will be programmed to include wind speed and directions. Attachment E in the CEQA document (Attachment E) provides additional details on the Odor Control Plan.

A charcoal filtration system will be installed on the two oil extraction, drying and processing buildings.

The Mono County General Plan allows composting activities in the AG LUD up to a maximum of 100 cubic yards of composted materials at a time and composting activities are required not to create a nuisance. No more than 100 cubic yards of compost will be present on the project site at a time consistent with the Mono County General Plan. Composted cannabis vegetation is a source of odors. The compost area will be covered when not in use to minimize odors. The NCM mister/fogger system described above will be installed over the compost area for odor control.

Lavender will be grown as an additional farm crop and a second scent barrier to any odors that could potentially occur outside of the greenhouses, storage/processing sheds, and composting areas. The lavender will cover 48,120 SF along North River Lane. With implementation of the odor control plan, it is not anticipated that any smell will occur outside of the buildings.

Two diesel generators will be on site in and event there is a power outage. Diesel emits air pollutants, which are regulated by the Great Basin Air Pollution Control District (GBUAPCD).

The Mono County General Plan and Land Development Regulations and the Mono County Regional Transportation Plan contain policies and standards concerning air quality that have been applied to this project; as follows:

Mono County General Plan, Land Use Element

Commercial Cannabis

- 13.070 E. Odor Control
 - 1. An odor mitigation plan is required to demonstrate that odors generated by the commercial cannabis activity shall not unreasonably impact adjacent properties and uses, or that odor mitigation measures are not applicable due to lack of cannabis-related odor generation, location or siting, design features, or other factors.

Mono County General Plan, Land Use Element

Countywide Land Use Policies

- Action 1L.3.e. Regulations shall provide for the limitation of odor nuisances for adjacent uses, which may include, but are not limited to, increased setbacks, minimum distances from existing structures under separate ownership, odor control filtration devices, and ventilation requirements.

Mono County General Plan, Conservation/Open Space Element

Public Health and Safety & Air Quality

- Policy 23.A.8. Encourage agricultural practices that reduce the amount of dust generated from tilling.
- Action 23.A.8.a. Work with local resource conservation districts, the US Natural Resources Conservation Service, agricultural officials, and the GBUAPCD to assist landowners in adjusting agricultural practices to reduce dust generation.

Determination

- The air quality impacts of the proposed agricultural cultivation project were analyzed in the FEIR certified in conjunction with the adoption of the Mono County General Plan.
- This parcel is no different than other parcels in the surrounding area; there is nothing unusual about the proposed project that would change or in any way affect the severity of these impacts. The impacts are not peculiar to the parcel or the project.
- There is no new substantial information indicating that the impacts of the project on air quality will be more severe than described in the FEIR.
- There are no cumulative or off-site impacts on air quality from the proposed project that were not addressed in the FEIR.

6) Transportation and Circulation

At full-build out a maximum of 10 employees are expected to work on site. There will be one full-time employee living in the barn apartment on the property. Up to three additional full-time employees will work on the property. During the harvest seasons (maximum 8 weeks out of the year) an additional 6 employees would work on site.

There are 14 parking sites on the site plan, 10 near the gate, two next to the manufactured home which will suffice for the workers vehicles, and two next to the apartment barn, which will also suffice for the workers vehicles. There are also temporary loading and unloading areas throughout the project area.

During non-harvest times, employee traffic could be three round trips per day, five days a week, or about 60 round trips per month. During harvest seasons, employee traffic could increase to as much as 9 round trips per day, five days a week, for about 45 round trips per week for four two-week periods. Employees will be encouraged to carpool to the site. Deliveries and shipping of products would occur twice per week via a delivery van. No semi-trailers are anticipated for regular farm operations. The traffic for the proposed project is comparable to traffic typical for a farm with a family of 4 to 6 persons that commute to school or work and have the need for additional workers for harvest. Depending on the crop, a typical farm could also be expected to have larger transportation and shipping vehicles, such as semi-trailers, which are not part of the proposed project.

The project area is accessed from Hwy 395 to Eastside Lane and then to North River Lane. The proposed project would increase traffic on all three access roads. Highway 395 is a designated interstate truck route and is designed for heavy traffic. Eastside Lane is a standard County collector/commercial (Class I for snow removal) maintained roadway designed for general uses (Mono County, 1981, 2013, 2014b).

North River Lane is a partially paved and partially unpaved private road. Private roads often do not meet the County Roadway Standards and as a result have not been accepted into the County Roadway Systems (Mono County, 2013, 2014b). The existing road is adequate for the passenger vehicles and the types of delivery vans to be used to access the property. The project proponent is committed to maintaining the existing road in its current condition to access their driveway. Access to the proposed farm driveway is approximately 1,650 feet along the paved portion of North River Lane from Eastside Lane along which there are approximately six other driveways.

This traffic is not expected to impact the existing traffic load and capacity above and beyond that of a typical 20-acre traditional farming operation with family and workers living on site. The project will not create barriers for pedestrians or bicyclists, nor will it conflict with policies supporting alternative transportation.

Determination

- The traffic and circulation impact of the proposed agricultural cultivation project were analyzed in the FEIR certified in conjunction with the adoption of the Mono County General Plan.
- This parcel is no different than other parcels in the surrounding area; there is nothing unusual about the proposed project that would change or in any way affect the severity of these impacts. The impacts are not peculiar to the parcel or the project.
- There is no new substantial information indicating that the traffic and circulation impacts of the project will be more severe than described in the FEIR.
- There are no cumulative or off-site traffic and circulation impacts from the proposed project that were not addressed in the FEIR.

7) Biological Resources

The project site has been historically disturbed (e.g. grading, vegetation clearing) and used as a residence in the recent past. The southern edge of the parcel boundary is mapped as a 0.2 percent chance flood hazard area by the Federal Emergency Management Agency (see FEMA map in Attachment A). The remainder of the parcel is not mapped as being subject to flooding. Additionally, the parcel is not mapped as wetland or floodplain by the U.S. Fish and Wildlife wetland/floodplain mapping database (see NWI map in Attachment A). The project is also providing a 30-foot setback from the drainages on the property (see Site Plan in Attachment A).

The site does not provide unique habitat for sensitive wildlife or plant species. The vegetative community is dominated by sagebrush with a depleted understory and overlies an excessively drained Mottsville loamy coarse sand. There is no potential for wetlands to exist on site due to the droughty soils and the existing upland vegetation.

Habitat is not unique compared to the surrounding area. Near the area proposed for building and greenhouse construction there are three irrigation ditches with a narrow band of riparian vegetation. Riparian vegetation will not be disturbed during construction or operation of the proposed project. The United States Fish and Wildlife Service was consulted to determine the likelihood of federally threatened or endangered species (TES), and these species are not likely to occur because habitat is not present. There are no sage-grouse leks present within 4km of the project site, which comply with requirements of the Mono County General Plan, Conservation and Open Space Element.

The Mono County General Plan and Land Development Regulations and the Mono County Regional Transportation Plan contain policies and standards concerning biological resources that have been applied to this project; i.e.,

Mono County General Plan, Land Use Element

Planning Area Land Use Policies: Antelope Valley

- Action 4.A.1.c. Limit the type and intensity of development in flood plain areas.
- Action 4.A.1.d. Prior to accepting a development application in potential wetland areas, require that the applicant obtain necessary permits from the US Army Corps of Engineers.

Mono County General Plan, Conservation/Open Space Element

Biological Resources

- Policy 2.A.9. Maintain water quality for fishery habitat by enforcing the policies contained in the Water Quality and Agriculture / Grazing/ Timber sections of the Conservation/Open Space Element.
- Action 2.A.1.g. Projects outside community areas within identified deer and sage grouse habitat areas, (see the Biological Resources Section of the Master Environmental Assessment), which may have a significant effect on deer or sage grouse resources shall submit a site-specific study performed by a recognized and experienced biologist in accordance with Action 1.1.
- Action 11.A.3.b. Ensure (or for non-county public lands advocate) for no adverse project impacts to biological resources and wildlife habitat in Mono County, including sage grouse habitat and wind energy development impacts to migratory birds.

Determination

- The biological resources impact of the proposed density of development were analyzed in the FEIR certified in conjunction with the adoption of the Mono County General Plan.
- This parcel is not unique from other parcels in the surrounding area; there is nothing unusual about the proposed project that would change or in any way affect the severity of these impacts. The impacts are not peculiar to the parcel or the project.
- There is no new substantial information indicating that the biological impacts of the project will be more severe than described in the FEIR.
- There are no cumulative or off-site biological impacts from the proposed project that were not addressed in the FEIR.

8) Energy and Mineral Resources

The proposed project does not require any additional uses of energy that exceed the current capability of the parcel. Note that the artificial lighting and other energy consumptive uses which are being used for the cultivation operation will be provided by Liberty Utility services via underground conduit. Initially, one backup generator will be installed as an emergency power source. Ultimately at full build-out, two diesel generators will be used as an emergency energy supply and have been evaluated per the requirements of 13.070. J.A maximum of 17,000 kilowatt (Kwh) per month is the estimated usage in electricity for the initial 5,000 square foot greenhouse. The full buildout of the 20,000 square feet of canopy can be estimated at about 58,000 Kwh per month in electricity. The proposed amount of electricity that will be consumed does not conflict with any adopted energy conservation plans and does not use non-renewable resources in a wasteful or inefficient manner compared to other uses that would be permitted in the AG LUD particularly those crops that are also grown in greenhouses. The use of electricity for the proposed project does not result in a loss of availability of a known mineral resource that would be of future value to the region or state.

Determination

- The energy and mineral resource impacts of the proposed agricultural cultivation project were analyzed in the FEIR certified in conjunction with the adoption of the Mono County General Plan.

- This parcel is no different than other parcels in the surrounding area; there is nothing unusual about the proposed project that would change or in any way affect the severity of these impacts. The impacts are not peculiar to the parcel or the project.
- There is no new substantial information indicating that the energy and mineral resource impacts of the project will be more severe than described in the FEIR.
- There are no cumulative or off-site energy and mineral resource impacts from the proposed project that were not addressed in the FEIR.

9) Hazards

Standard chemicals (pesticides, fertilizers, fuels, and lubricants used for agricultural activities) would be stored in one of the storage containers near the waste and composting area according to CDFA and any Mono County regulations. Fuel and lubricants would be stored in American Society for Testing Materials (ASTM) rated containers. All pesticides and fertilizers would be stored in the original containers in a cool and dry place off the floor and on impermeable surfaces. CDFA oversees licensee compliance of pesticides and fertilizers through the inspection and enforcement methods contained in the proposed regulations from reports from the County Agricultural Commissioner and other agencies. The Inyo and Mono Counties Agricultural Commissioner's Office conducts inspections roughly every year depending on the products being used (Nathan Reade, Agricultural Commissioner, Personal Comm. 11-29-2018). Pesticides, fungicides, rodenticides, and other plant protectants that are intended to be used are outlined in the Integrated Pest Management Plan (Attachment B). Waste management operations are detailed in the Waste Management Plan (Attachment C).

The project area is near a Special Flood Hazard Area (see FEMA Map Attachment A) and in a Moderate Fire Hazard Severity Zone (http://frap.fire.ca.gov/webdata/maps/mono/fhszlo6_1_map.26.pdf). The project is under the Antelope Valley Fire Protection District and the appropriate will-serve letter has been documented.

The proposed project will not impair implementation of or physically interfere with an adopted emergency response plan or emergency evacuation plan.

Determination

- The hazards impact of the proposed agricultural cultivation project was analyzed in the FEIR certified in conjunction with the adoption of the Mono County General Plan.
- This parcel is no different than other parcels in the surrounding area; there is nothing unusual about the proposed project that would change or in any way affect the severity of these impacts. The impacts are not peculiar to the parcel or the project.
- There is no new substantial information indicating that the hazards impact of the project will be more severe than described in the FEIR.
- There are no cumulative or off-site hazards impacts from the proposed project that were not addressed in the FEIR.

10) Noise

Construction and/or cultivation activities may involve the temporary use of construction equipment that may emit noise at levels greater than 60 decibels. These activities are typical for construction on agricultural lands. Mono County General Plan Noise Element limits maximum exterior noise levels for agricultural operations to 65 dBA at all times when measured at or within the real property line of the receiving property.

In the event of electrical utility failure, backup diesel generators will be used (two at full build-out). Each proposed KD 110 generator emits 66 decibels at a distance of 22 feet, and both are placed at a minimum of 30 feet from the property line. In addition, the noise ordinance does not apply to the generation of sound in the performance of emergency work, including the use of generators, both fixed and mobile, during power outages.

The project will not increase the existing noise levels above that typical for an agricultural operation and will not expose people to severe noise levels. Noise levels for alternative power for cannabis production will comply with the requirements of 13.070.J. The project will follow all requirements of the County's Noise Ordinance (Mono County Code, Chapter 10.16) and will follow all requirements of 13.070. J.

The project is consistent with the surrounding agricultural uses of the proposed project, and consistent with the General Plan, including the following goals and policies:

Mono County General Plan, Conservation/Open Space Element

Agriculture, Grazing and Timber

- Policy 5.B.2. The primary use of any parcel within an agricultural land use category shall be agricultural production and related processing, support services and visitor-serving services. Residential uses in these areas shall recognize that the primary use of the land may create agricultural "nuisance" situations such as flies, noise, odors, and spraying of chemicals.

Mono County General Plan, Noise Element

- Policy 1.A.1. The County shall consider the compatibility of proposed land uses and the noise environment when preparing or revising General Plan and community plan documents and when reviewing development proposals. Noise levels for proposed land uses should be consistent with the Maximum Allowable Noise Exposure by Land Use (Table 1); the total noise level resulting from new sources and ambient noise shall not exceed the standards in this Element and in the Mono County Noise Ordinance (Mono County Code, Chapter 10.16; Mono County General Plan Amendment 18-01; Mono County Development Standards Chapter 13).

Mono County General Plan, Land Use Element

Commercial Cannabis

- 13.070 J. Noise
 - 1. Noise generation shall comply with the Mono County General Plan Noise Element and Mono County Code, Chapter 10.16
 - 2. The General Plan Noise Element shall apply to all commercial cannabis activities.
 - 3. The Planning Commission may approve the use of a "fixed noise source," as defined in the Mono County Code Chapter 10.16, or "generator" as defined in state law and regulation, provided certain criteria are considered, including but not limited too
 - i. Applicant has successfully demonstrated compliance with Mono County Code Chapter 10.16 and all applicable local and State law regulation;
 - ii. Appropriate sound-deadening features and infrastructure have been installed where applicable; and
 - iii. Impacts on adjacent properties and the neighborhoods have been evaluated and considered negligible; and
 - iv. The premise location has power constraints such that the prohibition of the use of such equipment would be overly burdensome on the operation.

Determination

- The noise impacts of the proposed agricultural cultivation project were analyzed in the FEIR certified in conjunction with the adoption of the Mono County General Plan.
- This parcel is no different than other parcels in the surrounding area; there is nothing unusual about the proposed project that would change or in any way affect the severity of these impacts. The impacts are not peculiar to the parcel or the project.
- There is no new substantial information indicating that noise impacts of the project will be more severe than described in the FEIR.
- There are no cumulative or off-site noise impacts from the proposed project that were not addressed in the FEIR.

- Noise impacts from the proposed project that were not addressed in the FEIR.

11) Public Services

The project is located within the Antelope Valley Fire District and will be required to comply with their regulations and the County's Fire Safe Regulations (Mono County Land Development Regulations, Chapter 22). As a part of these requirements, the permittee has prepared and submitted a Fire Prevention Plan for construction and ongoing operations and obtained a Will-Serve letter from the local fire protection district. The Fire Prevention Plan shall include, but not be limited to emergency vehicle access and turnaround at the facility site(s), vegetation management and firebreak maintenance around all structures.

Police protection is provided by the Mono County Sheriff's Department. The project will be circulated to the Sheriff as part of the Operation Permit approval.

The site meets all Calfire requirements of 4290 and 4291. The project area is within Calfire's Local Responsibility Area (LRA) authority. A site visit with the Antelope Valley Fire Protection District chief was conducted and there were site plan changes to access as a result of the site visit. Site plan changes included placement of a 10,000-gallon water tank for fire suppression at the front of the property and extension of the one-way road to a second access point on North River Lane

Determination

- The public service impacts of the proposed agricultural cultivation project were analyzed in the FEIR certified in conjunction with the adoption of the Mono County General Plan.
- This parcel is no different than other parcels in the surrounding area; there is nothing unusual about the proposed project that would change or in any way affect the severity of these impacts. The impacts are not peculiar to the parcel or the project.
- There is no new substantial information indicating that the public service impacts of the project will be more severe than described in the FEIR.
- There are no cumulative or off-site public service impacts from the proposed project that were not addressed in the FEIR.

12) Utilities and Service Systems

The proposed project will be served by existing utilities and service systems. Underground utilities include electricity, telephone, and residential water. Mono County landfill facilities are not expected to be impacted by the proposed project. Organic waste will be composted on site in compliance with the Mono County General Plan and the LRWQCB is responsible to for overseeing the operation to prevent impacts to water quality (Attachment D). Water service is provided by an existing well. Demand on the other utilities is not expected to increase appreciably above and beyond typical agricultural uses. Waste management operations are detailed in the Waste Management Plan (Attachment C).

Determination

- The utilities and service systems impact of the proposed agricultural cultivation project were analyzed in the FEIR certified in conjunction with the adoption of the Mono County General Plan.
- This parcel is no different than other parcels in the surrounding area; there is nothing unusual about the proposed project that would change or in any way affect the severity of these impacts. The impacts are not peculiar to the parcel or the project.
- There is no new substantial information indicating that the utilities and service systems impacts of the project will be more severe than described in the FEIR.
- There are no cumulative or off-site utilities and service systems impacts from the proposed project that were not addressed in the FEIR.

13) Aesthetics

The project site is not located adjacent to a county or state scenic highway. It is adjacent to parcels with agricultural LUDs to the north and is adjacent to estate residential parcels south of North River Lane. Due to the nature of proposed grow operations (greenhouses), crop cultivation will not substantially degrade the visual quality of the surrounding area. There is an existing overhead utility line on the property and any new utility lines will be undergrounded. All interior lighting on greenhouses are required to have blackout shade covers from dusk to dawn and ancillary structures will comply with the Mono County General Plan regulations for dark sky (Chapter 23). Buildings will be painted to match surrounding dark earth tones in coordination with Mono County. Perimeter fencing will be installed with a decorative, wooden main access gate, see Attachment A for design plans and color chips of proposed building color. All exterior lighting will be downward directed and shielded in order to comply with Chapter 23, Darky Sky Regulations.

There will be two lavender grows that cover 48,120 SF along North River Lane which will enhance views to the property. At a later date, the grown lavender will be extracted to produce lavender oil. Additionally, a shelterbelt of trees (Leyland Cypress and Sambuca Black Lace in photos 4 and 5 in the project description) will surround the operations to improve the view from the public right-of-way. The purpose of the aesthetic enhancements is to increase the appealing nature of the property to the landowners and viewers alike. With these proposed actions, the property will be enhanced to reflect the culture and character of the area. The proposed agricultural activities are compatible with the character of the lands in Antelope Valley and with the agricultural character that Antelope Valley policies intend to preserve.

One hanging sign is proposed and will be located at the front of the property over the main entry gate. Refer to Photo 5 to see an example of the proposed sign design and refer to Photo 6 to see the company logo design.

The Mono County General Plan and Land Development Regulations contain policies and standards concerning visual resources/aesthetics that have been applied to this project; as follows:

Mono County General Plan Conservation/Open Space Element

Visual Resources

- Policy 20.A.3. Preserve the visual identity of areas outside communities.
- Policy 20.C.2. Future development shall be sited and designed to be in scale and compatible with the surrounding community and/or natural environment.

Planning Area Land Use Policies: Antelope Valley

- Policy 4.B.1. Maintain and enhance scenic resources in the Antelope Valley.
- Policy 4.B.2. Preserve the agricultural lands and natural resource lands in the Antelope Valley.
- Policy 4.B.6. Preserve rural character of lands within the Antelope Valley.

Mono County General Plan, Land Use Element

Commercial Cannabis

- 13.070.G. *Visual Screening/Fencing.*
 - 1. *All Cannabis, Cannabis Products and Cannabis Accessories shall be screened from view from a public right of way to the best of the Permittee's ability.*
 - 2. *Fencing installed on or around the premises shall comply with all other applicable County and State laws and regulations regarding height and location restrictions.*
 - 3. *If linear features are proposed, a Visual Screening Plan is required to demonstrate visual compatibility with the surrounding landscape, views, and/or community character,*

including but not limited to fencing. A Visual Screening Plan shall be submitted with the application and be compatible with:

- *i. General Plan Land Use Element, Conservation/Open Space Element 05-02 Issues/Opportunities/Constraints, Visual Resources and 05-03 Policies, Visual Resources;*
- *ii. General Plan Land Use element 02-06 Land Development Regulations, Chapter 4.160 Fences, Screening and Landscaping;*
- *iii. General Plan Appendices, 09-03 Mono County General Design Guidelines, Chapter 2, Site Planning & Landscape; and*
- *iv. Landscaping species shall be consistent with those identified in General Plan Appendices 09-03, Mono County General Design Guidelines, "Plants".*
- *Visual screening shall blend into the surrounding landscape as best as possible.*
- *13.070.H. Lighting.*
 - *1. A Lighting Plan demonstrating compliance with the following:*
 - *i. All commercial cannabis activities shall comply with General Plan Land Use Element Chapter 23-Dark Sky Regulations regardless of activity type or Premise location.*
 - *ii. Design specifications and/or cut sheets for all proposed exterior lighting shall be detailed in the Lighting Plan.*
 - *2. Commercial cannabis activities located north of Mountain Gate Park shall comply with Land Use Element Chapter 23- Dark Sky Regulations.*
- *13.080.B. Lighting. Interior light systems shall include window coverings to confine light and glare to the interior of the structure and be detailed within the Lighting Plan. Light mitigation measures shall be utilized from sunset to sunrise to avoid nighttime glare, as required in California Department of Food and Agriculture State Code 8304.*

Determination

- The aesthetic impacts of the proposed agricultural cultivation project were analyzed in the FEIR certified in conjunction with the adoption of the Mono County General Plan.
- This parcel is no different than other parcels in the surrounding area; there is nothing unusual about the proposed project that would change or in any way affect the severity of these impacts. The impacts are not peculiar to the parcel or the project.
- There is no new substantial information indicating that the aesthetic impacts of the project will be more severe than described in the FEIR.
- There are no cumulative or off-site aesthetic impacts from the proposed project that were not addressed in the FEIR.

14) Cultural Resources

The project area lies within a previously disturbed area (e.g. grading, vegetation clearing) which was abandoned prior to Colitas Farms purchasing the property.

A record search covering a 0.5-mile radius surrounding the project area was requested of the Eastern Information Center (EIC). No archaeological sites near the project area have been determined to be eligible for The California Register of Historical Resources or the National Register of Historic Places. None are listed on the California Inventory of Historic Resources. A copy of correspondence from the California Historical Resources Information System is included as Attachment F.

California Health and Safety Code 7050.5 states in the event of discovery or recognition of any human remains in any location other than a dedicated cemetery, there shall be no further excavation or disturbance of the site or any nearby area reasonably suspected to overlie adjacent remains until the coroner of the County inspects the site. Furthermore, California Public Resources code states upon the discovery of Native American remains, the landowner shall ensure that the immediate vicinity where the Native American human remains are located, is not

damaged or disturbed by further development activity until the landowner has been contacted. The conditions of approval for the use permit reflect these work stoppage requirements.

Determination

- The cultural resource impacts of the proposed agricultural cultivation project were analyzed in the FEIR certified in conjunction with the adoption of the Mono County General Plan, and because the property was in agricultural production for many years no known archeological sites exist on the property.
- This parcel is no different than other parcels in the surrounding area; there is nothing unusual about the proposed project that would change or in any way affect the severity of these impacts. The impacts are not peculiar to the parcel or the project.
- A standard mitigation measure is being applied in the event human remains are uncovered.
- There is no new substantial information indicating that the impacts of the project on cultural resources will be more severe than described in the FEIR.
- There are no cumulative or off-site impacts from the proposed project on cultural resources that were not addressed in the FEIR.

15) Recreation

The project will not affect existing recreational opportunities since it is in an existing private agricultural area and most of the recreational opportunities in Mono County occur on public lands. The project also does not generate a significant number of new residents that would impact existing recreational facilities.

Determination

- The recreation impacts of the proposed agricultural cultivation project were analyzed in the FEIR certified in conjunction with the adoption of the Mono County General Plan.
- This parcel is no different than other parcels in the surrounding area; there is nothing unusual about the proposed project that would change or in any way affect the severity of these impacts. The impacts are not peculiar to the parcel or the project.
- There is no new substantial information indicating that the impacts of the project on recreation will be more severe than described in the FEIR.
- There are no cumulative or off-site impacts from the proposed project on recreation that were not addressed in the prior EIR.

16) Greenhouse Gases

Mono County conducted a baseline GHG emission inventory, GHG emission forecast and reduction targets and policies and programs to achieve reduction targets. The inventory includes analysis of County government activities and emissions associated with energy use (residential and nonresidential), transportation, off road equipment, solid waste generation, water and wastewater transportation, residential/non-residential agriculture, and landfills (Mono County Resource Efficiency Plan, 2014a). The GHG inventory provided Mono County the information to assess the effectiveness of recommended policies and programs to reduce GHG and consumption of resources. The document details that 2010 emissions of 21,920 MTCO₂e per year for known agriculture emissions, are generated by livestock gestation (99%) and fertilizer application (1%). Emissions are projected to remain stable from 2020 through 2035. Agriculture operations emissions comprise 16% of total baseline emissions in Mono County, making agriculture the fourth largest producer of GHG. While a large contributor of GHG, agriculture projections remain stable, and the promotion of optimal agriculture practices for fertilizer application will subtract 20 MTCO₂e from total emissions, or 12,440 pounds of fertilizer.

The Mono County Sustainable Agricultural Strategy (2018) references Mono County's Resource Efficiency Plan as a baseline of emissions within the community and government operations. Based on the greenhouse gas emission

inventory and analysis of threats, the strategy includes a toolbox to provide initiatives, programs, and policies that support a sustainable agricultural industry in Mono County. Cannabis is a high-value crop that can be grown on a smaller land base in comparison to traditional crops, which would result in lower greenhouse gas emissions. In addition, fertilizer application is more targeted than traditional row and row cultivation, which reduces GHG emissions as noted above.

As detailed in the Transportation and Circulation section, at full-build out a maximum of 10 employees are expected to work on site. During non-harvest times, employee traffic could be three round trips per day, five days a week, or about 60 round trips per month. During harvest seasons, employee traffic could increase to as much as 9 round trips per day, five days a week, for about 45 round trips per week for four two-week periods. GHG emissions regarding workers at the site would be similar to that of a typical 19 acres traditional farming operation with family and workers living on site.

In the event of electrical utility failure, backup diesel generators will be used (two at full build-out). Each KD 110 generator would emit GHG, however the amount would depend on the length of the power outage. It is anticipated that GHG emissions due to emergency generator use would be de minimis.

Determination

- The greenhouse gas impacts of the proposed agricultural cultivation project were analyzed in the FEIR certified in conjunction with the adoption of the Mono County General Plan.
- This parcel is no different than other parcels in the surrounding area; there is nothing unusual about the proposed project that would change or in any way affect the severity of these impacts. The impacts are not peculiar to the parcel or the project.
- There is no new substantial information indicating that the impacts of the project on greenhouse gases will be more severe than described in the FEIR.
- There are no cumulative or off-site impacts to greenhouse gases from the proposed project that were not addressed in the FEIR.

VII. DETERMINATION

Based on this initial evaluation:

I find that the proposed infill project WOULD NOT have any significant effects on the environment that have not already been analyzed. Pursuant to Public Resources Code §21083.3 and CEQA Guidelines §15183, projects that are consistent with the development density of existing zoning, community plan or general plan policies for which an EIR was certified shall be exempt from additional CEQA analysis except as may be necessary to determine whether there are project-specific significant effects that are peculiar to the project or site that would otherwise require additional CEQA review.

A Notice of Determination (§15094) will be filed:

I find that although the proposed project could have a significant effect on the environment, there will not be a significant effect in this case because the mitigation measures described on an attached sheet have been added to the project and/or revisions in the project have been made by or agreed to by the project proponent.

A Negative Declaration will be prepared:

I find the proposed project MAY have a significant effect on the environment.

Environmental Impact Report is required:

I find that the proposed project MAY have a significant effect(s) on the environmental, but at least one effect 1) has been adequately analyzed in an earlier document pursuant to applicable legal standards, and 2) has been addressed by mitigation measures based on the earlier analysis as described on attached sheets, if the effect is a "potentially significant impact" or "potentially significant unless mitigated."

An Environmental Impact Report is required, but it must analyze only the effects that remain to be addressed.

I find that although the proposed project could have a significant effect on the environment, there WILL NOT be a significant effect in this case because all potentially significant effects (a) have been analyzed adequately in an earlier EIR or NEGATIVE DECLARATION pursuant to applicable standards and (b) have been avoided or mitigated pursuant to that earlier EIR or NEGATIVE DECLARATION, including revisions or mitigation measures that are imposed upon the proposed project, and uniformly applied development standards are required.

Hailey Lang
Signature

10-9-19
Date

Hailey Lang
Printed Name

VIII. REFERENCES

- Jonathan P. Caulkins, 2010. Estimated Cost of Production for Legalized Cannabis. RAND Drug Policy Research Center.
https://www.researchgate.net/profile/Jonathan_Caulkins/publication/265453640_Estimated_Cost_of_Production_for_Legal_Cannabis/links/550c11530cf2063799398419/Estimated-Cost-of-Production-for-Legal-Cannabis.pdf
- Mono County Code.
- Mono County, 1981. Road Improvement Standards
- Mono County, 2013. Regional Transportation Plan
- Mono County, 2014a. Resource Efficiency Plan.
- Mono County, 2014b. Snow Removal Priority Map 10-21-14
- Mono County, 2015. General Plan. <https://monocounty.ca.gov/planning/page/general-plan>
- Mono County, 2015. General Plan Environmental Impact Report. <https://monocounty.ca.gov/planning/page/general-plan-eir>
- Mono County, 2018. Sustainable Agricultural Strategy.

Attachment A

Site Plans and Maps

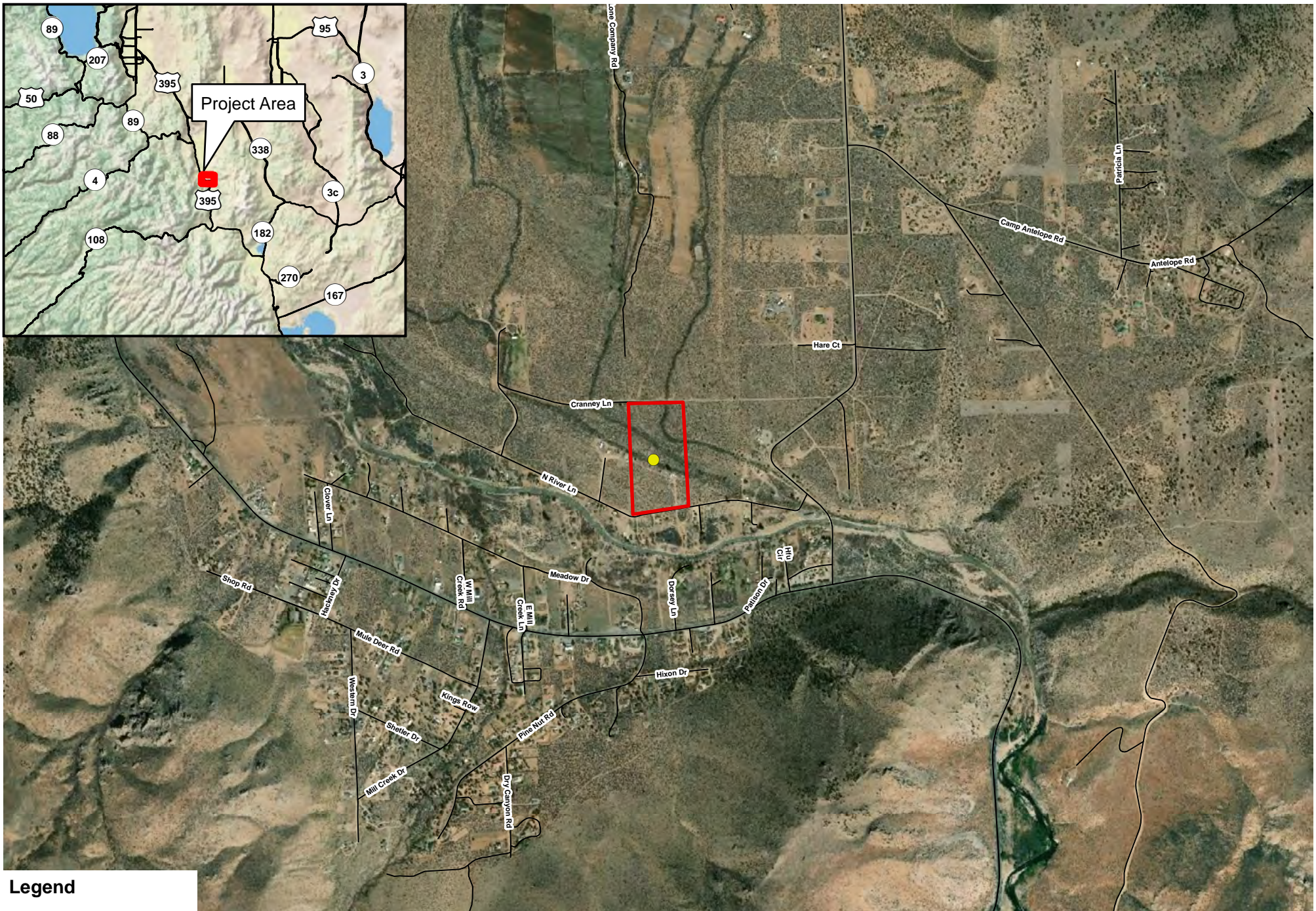
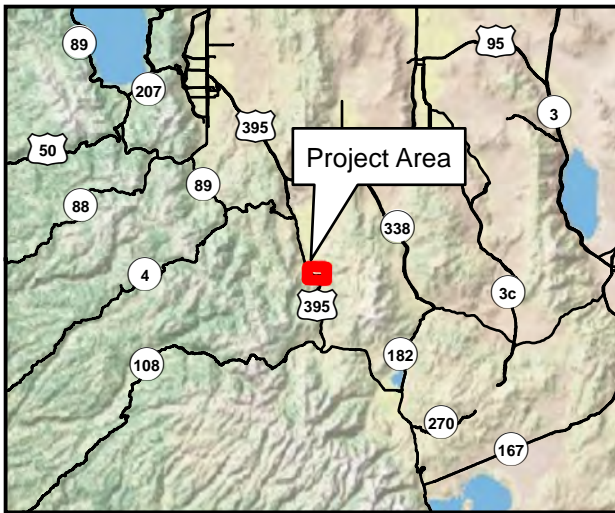

Legend

- Project Location
- Parcel

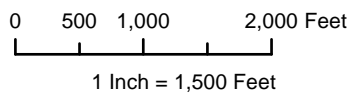

Colitas Farms Location Map

6/3/2019

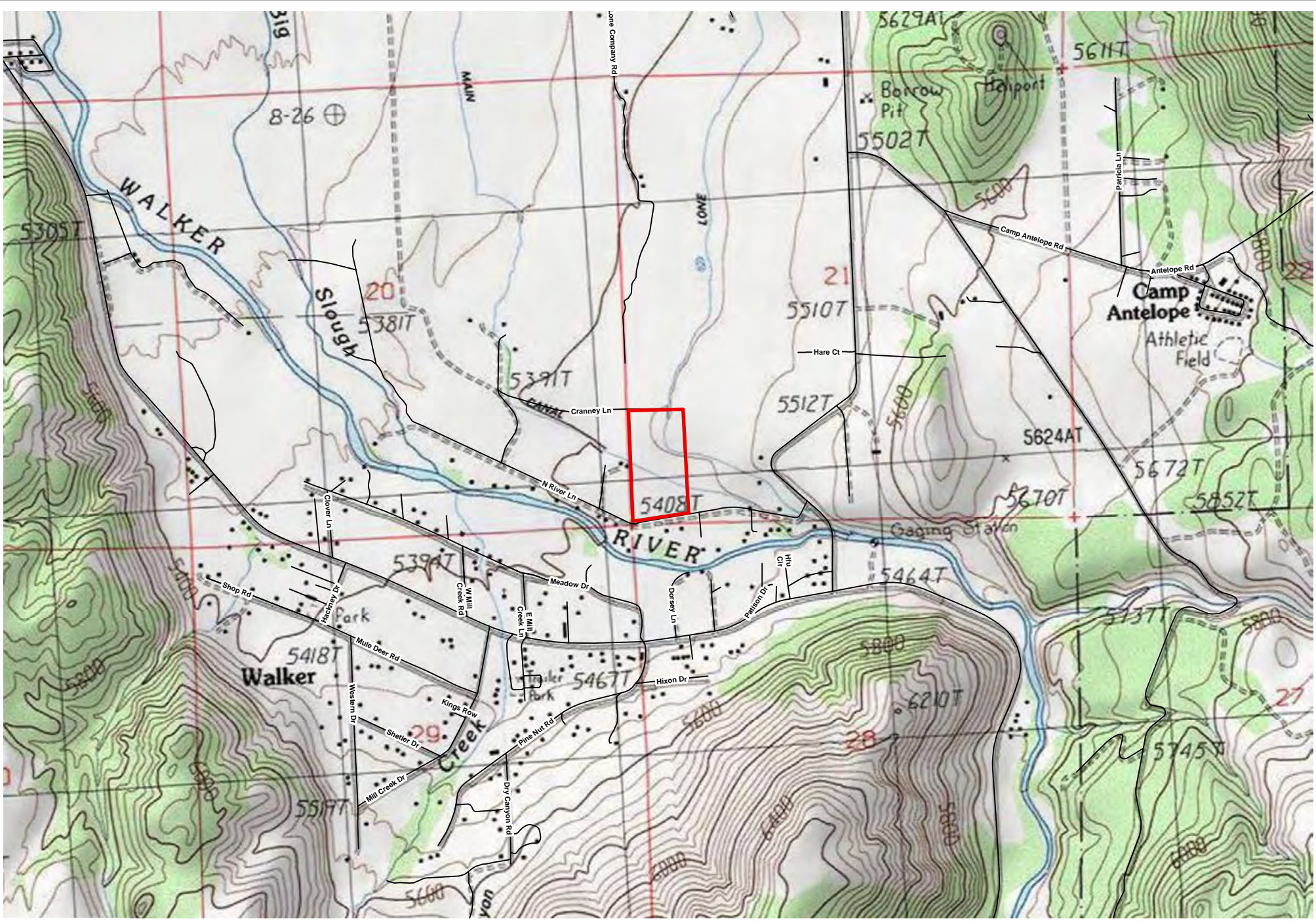

Legend
 Parcel

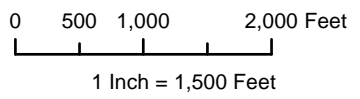

Colitas Farms Topography Map

N 6/21/2019

 Resource Concepts Inc

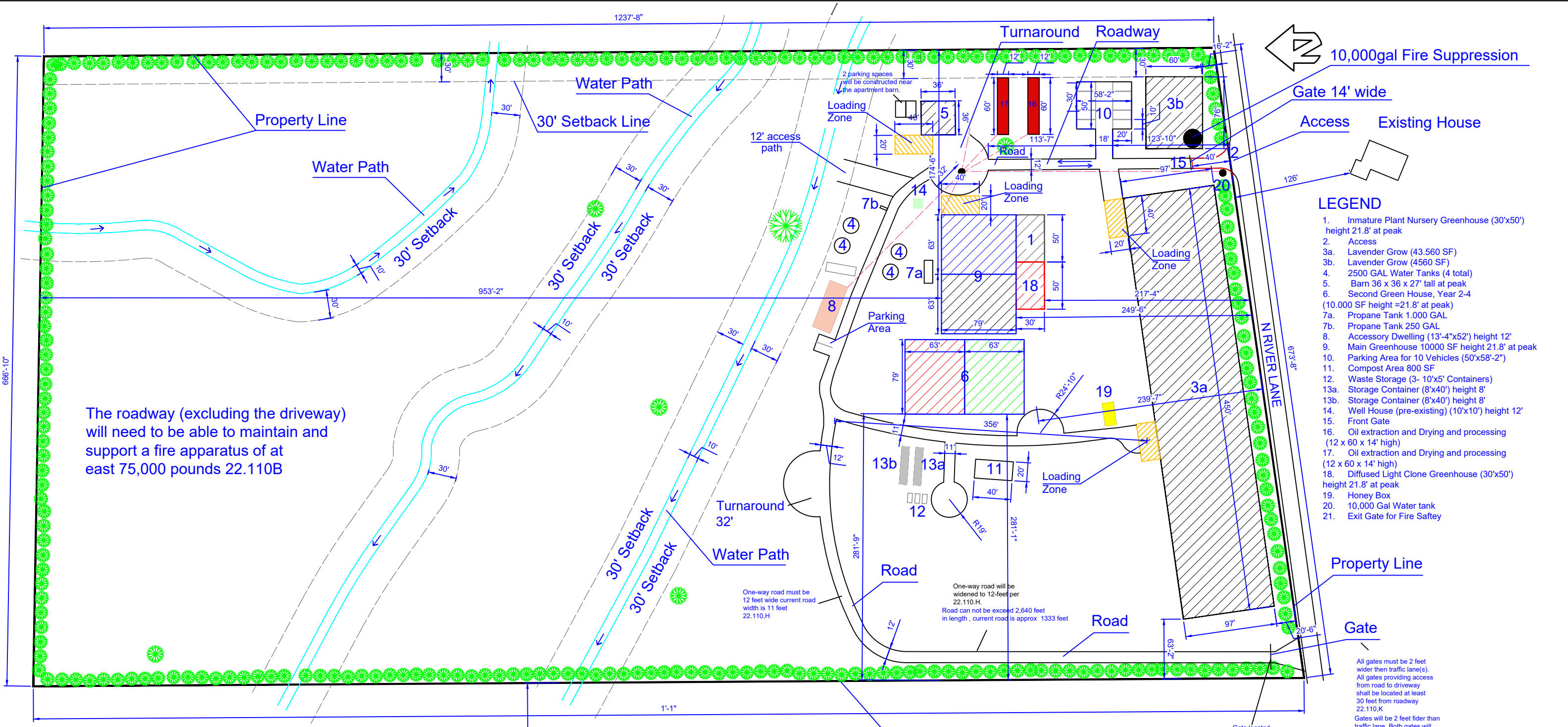

The roadway (excluding the driveway) will need to be able to maintain and support a fire apparatus of at east 75,000 pounds 22.110B

10,000gal Fire Suppression

Gate 14' wide

Access Existing House

LEGEND

- 1. Immature Plant Nursery Greenhouse (30'x50') height 21.8' at peak
- 2. Access
- 3a. Lavender Grow (43,560 SF)
- 3b. Lavender Grow (4560 SF)
- 4. 2500 GAL Water Tanks (4 total)
- 5. Barn 36 x 36 x 27' tall at peak
- 6. Second Green House, Year 2-4 (10,000 SF height =21.8' at peak)
- 7a. Propane Tank 1,000 GAL
- 7b. Propane Tank 250 GAL
- 8. Accessory Dwelling (13'-4"x52') height 12'
- 9. Main Greenhouse 10000 SF height 21.8' at peak
- 10. Parking Area for 10 Vehicles (50'x58'-2")
- 11. Compost Area 800 SF
- 12. Waste Storage (3- 10'x5' Containers)
- 13a. Storage Container (8'x40') height 8'
- 13b. Storage Container (8'x40') height 8'
- 14. Well House (pre-existing) (10'x10') height 12'
- 15. Front Gate
- 16. Oil extraction and Drying and processing (12 x 60 x 14' high)
- 17. Oil extraction and Drying and processing (12 x 60 x 14' high)
- 18. Diffused Light Clone Greenhouse (30'x50') height 21.8' at peak
- 19. Honey Box
- 20. 10,000 Gal Water tank
- 21. Exit Gate for Fire Saftey

Property Line

Gate

All gates must be 2 feet wider then traffic lane(s). All gates providing access from road to driveway shall be located at least 30 feet from roadway 22.110.K Gates will be 2 feet fider than traffic lane. Both gates will be located at least 30-feet away from the roadway per 22.110.K

One-way road must be 12 feet wide current road width is 11 feet 22.110.H

One-way road will be widened to 12-feet per 22.110.H. Road can not be exceed 2,640 feet in length , current road is approx 1333 feet

VICINITY MAP, NOT TO SCALE



Existing House

Notes:

- 1. Driveway is approximately 356 feet.
- 2. Road cannot exceed 2,460 feet in length. Road is approximately 1,333 feet.
- 3. Radius of turnouts will need to be confirmed during the building permit process.
- 4. The roadway (excluding the driveway) will need to be able to maintain and support a fire apparatus of at least 75,000 pounds per 22.110.B.

Parcel No. (APN)	002-460-015-000
Lot Area	816.239 SF
Total Lot Coverage	118.500 SF 14.5%

**324 N RIVER LN
COLEVILLE, CA 96107
Scale: 1"=100'**



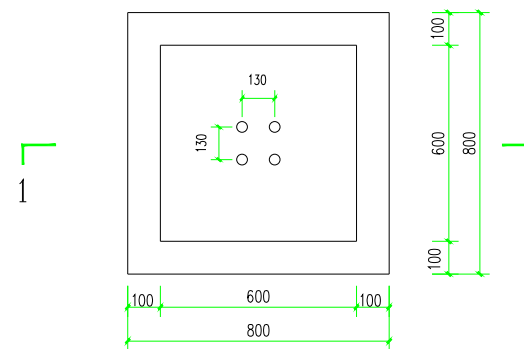
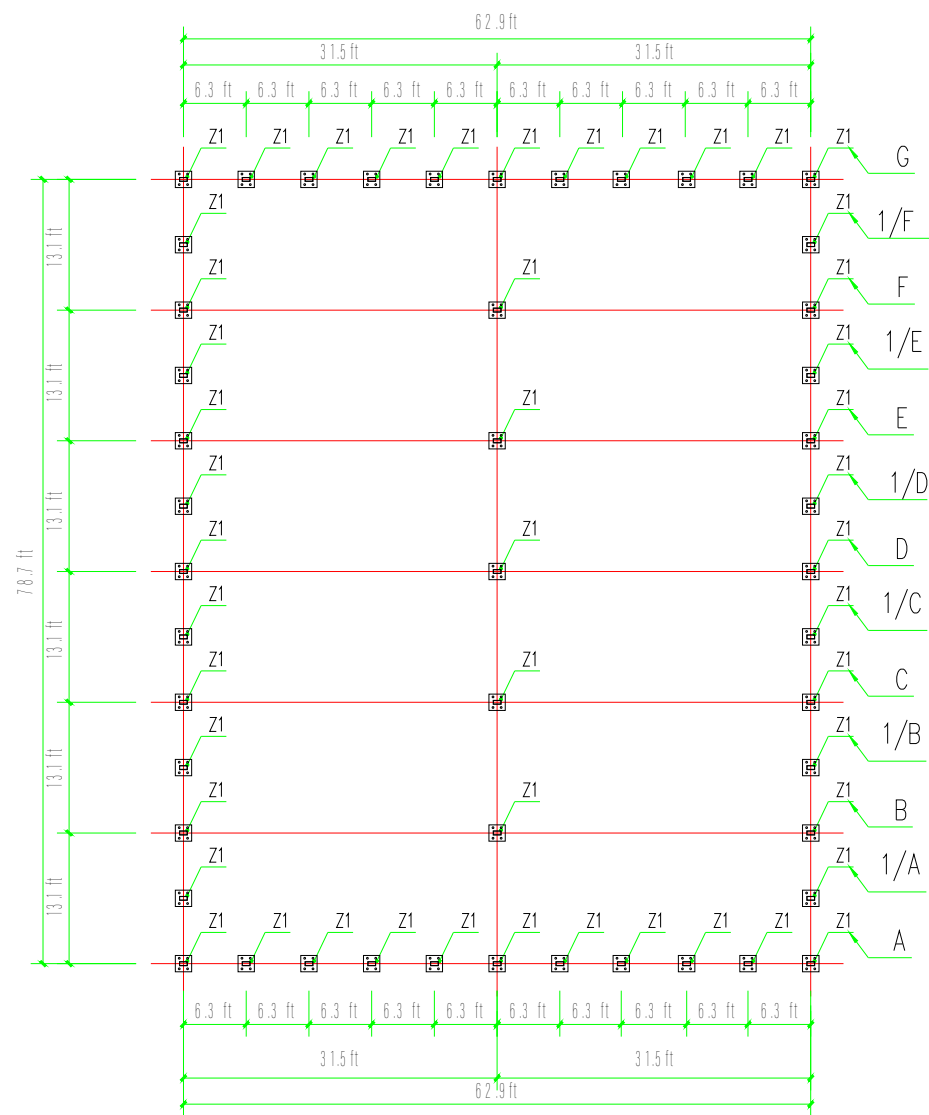

Z1 Foundation layout

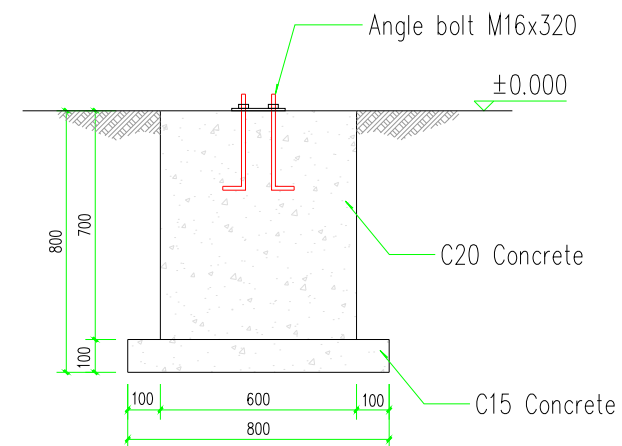

1-1 Section layout

note:

1. Foundation excavation to the bearing layer;
2. According to the local soil and geological structure, make corresponding adjustments to the point-based approach.

(CLIENT:)

PROJECT NAME

SUB PROJECT

(DWG. NAME:)

unit :

scale :

PROJECT LEADER

DIVISION CHIEF

DESIGNED BY

PROCESSED BY

CHECKED BY

APPROVED BY

PROJECT NO.

DWG TYPE

DWG. NO.

Ver.

DATE

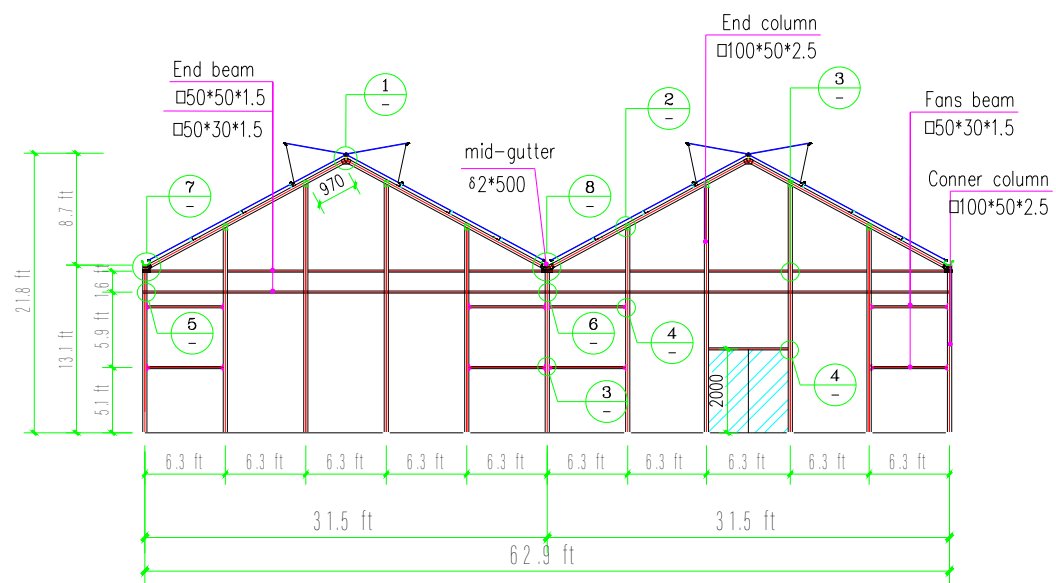

Ⓐ Front end frame diagram

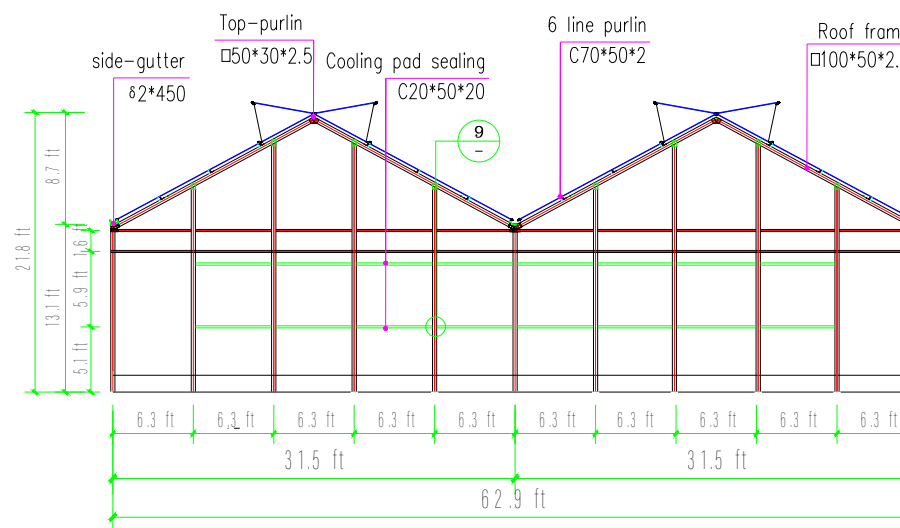

Ⓒ Back end frame diagram

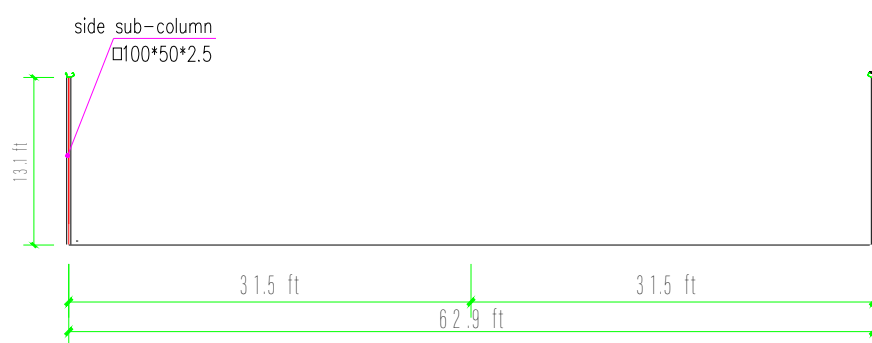

1/(A-F) Section frame diagram

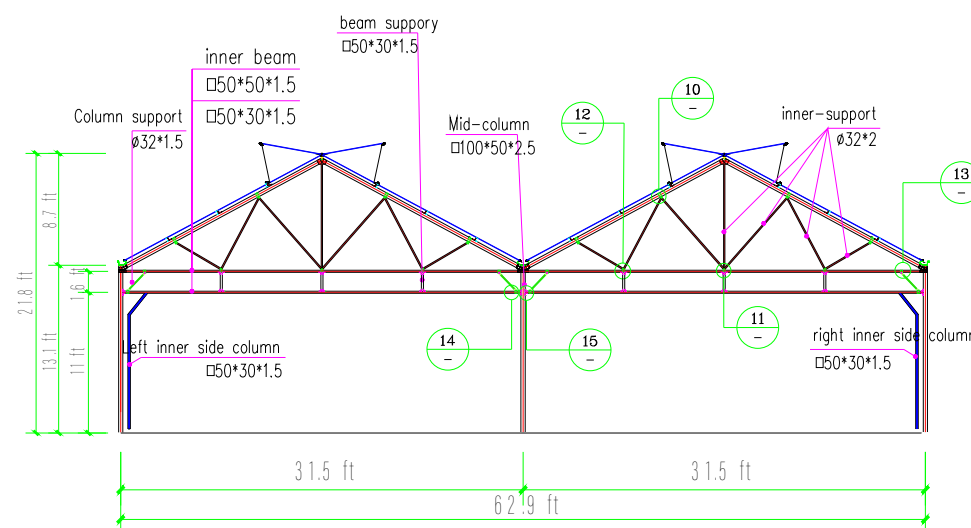

Ⓑ, Ⓒ, Ⓓ, Ⓔ, Ⓕ Section frame diagram

(CLIENT:)

PROJECT NAME

SUB PROJECT

(DWG. NAME:)

unit : scale :

PROJECT LEADER

DIVISION CHIEF

DESIGNED BY

PROCESSED BY

CHECKED BY

APPROVED BY

PROJECT NO.

DWG TYPE

DWG. NO.

Ver.

DATE

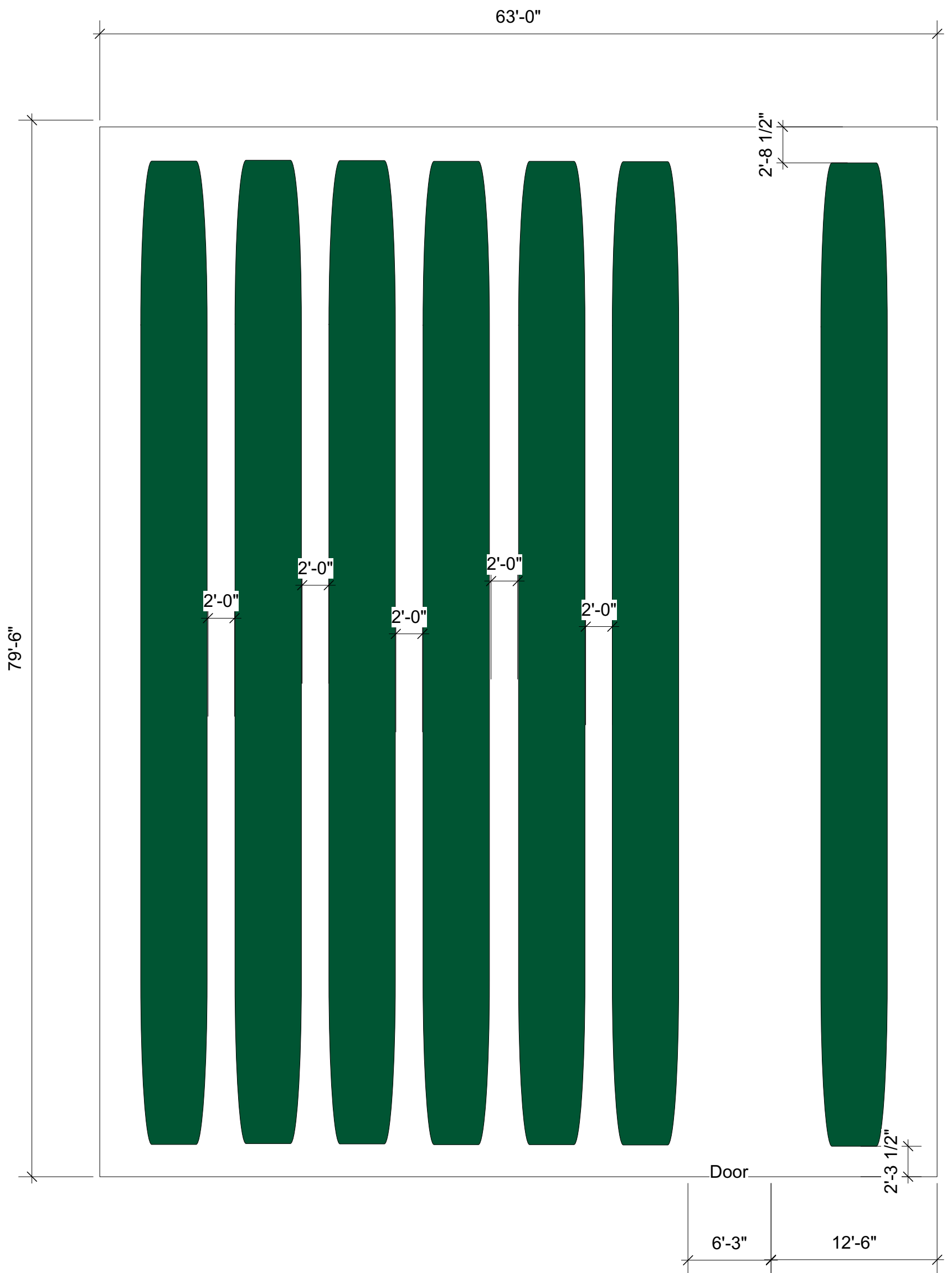

GREENHOUSE FLOORPLAN
 FOR ONE 63 X 79' STRUCTURE
 5' PLANTED ROWS SPACED 2' APART

Oil extraction/Drying, processing and storage

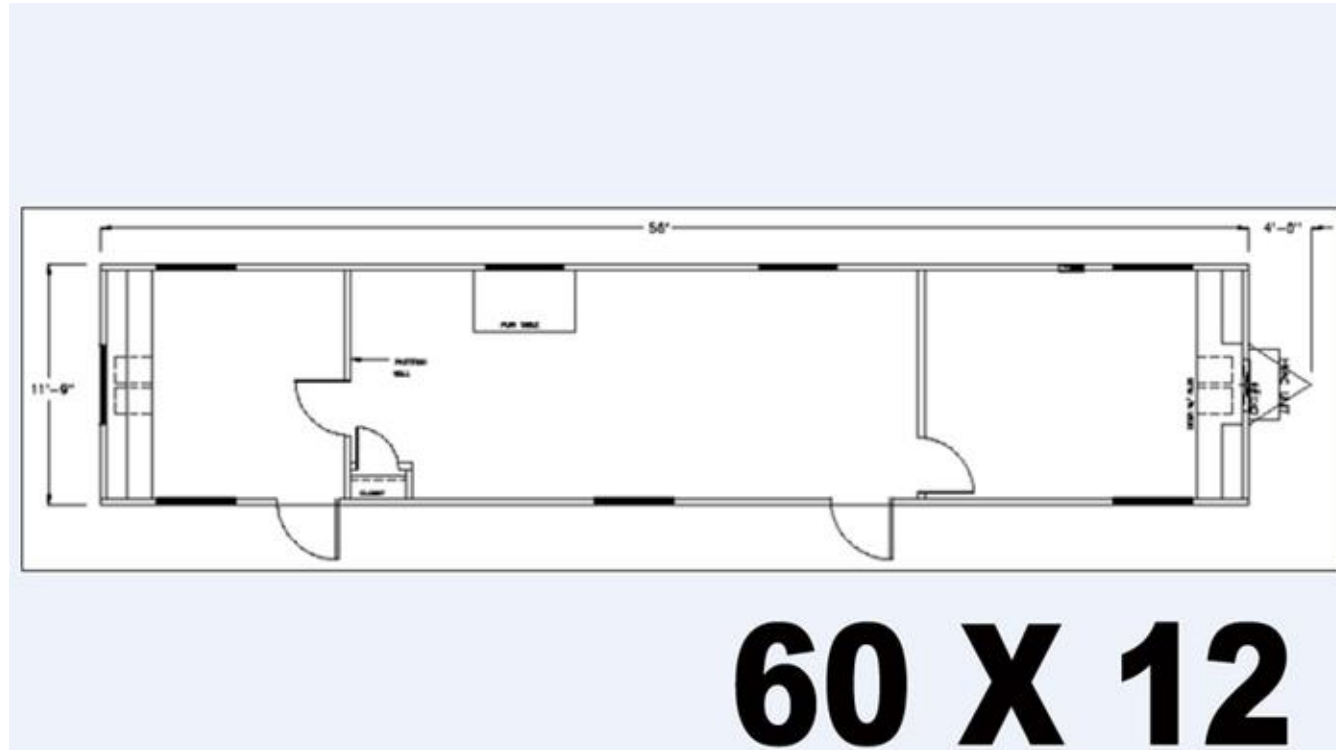

12' x 12' drying area, 12' x 15' processing area, 12' x 29' Oil extraction room



DesignSource
866-869-7777

DesignSource
866-869-7777

1465M

MODULAR HOME

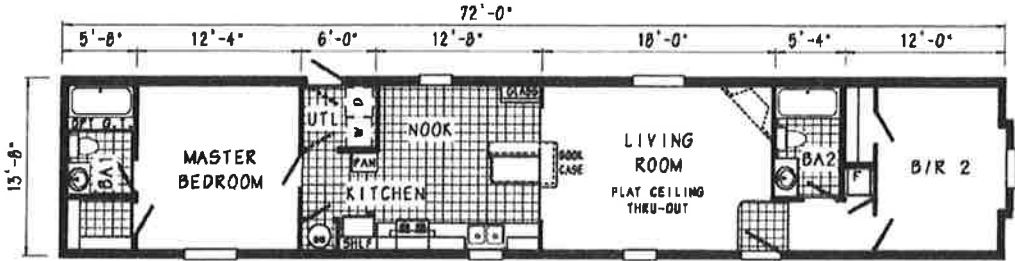

JB540-A 1472 Approx. 984 Sq. Ft.

PROVIDENCE
Commodore Homes of Pennsylvania

<https://kelseybassranch.com/20-perfect-images-trailer-home-dimensions/manufactured-homes-mobile-single-wide-floor-plans-8/>



DesignSource
866-869-7777

DesignSource
866-869-7777

1465M

BARN PROS[®]

NATIONWIDE

DENALI 36 BARN APARTMENT

Model A - front



© 2016 BARN PROS INC

Request a **FREE** Denali Apartment e-brochure. Call: **1-866-844-2276**

WWW.BARNPROS.COM • 1 OF 10

BARN PROS[®]

NATIONWIDE

DENALI 36 BARN APARTMENT

Model A - rear



© 2016 BARN PROS INC

Request a **FREE** Denali Apartment e-brochure. Call: **1-866-844-2276**

WWW.BARNPROS.COM • 2 OF 10

Barn Pros Denali 36 Apartment Barn Model A - Standard



Front Elevation



Side Elevation, Left



Rear Elevation



Side Elevation, Right

© 2016 BARN PROS INC

Barn Pros Denali 36 Apartment Barn Model A - Standard

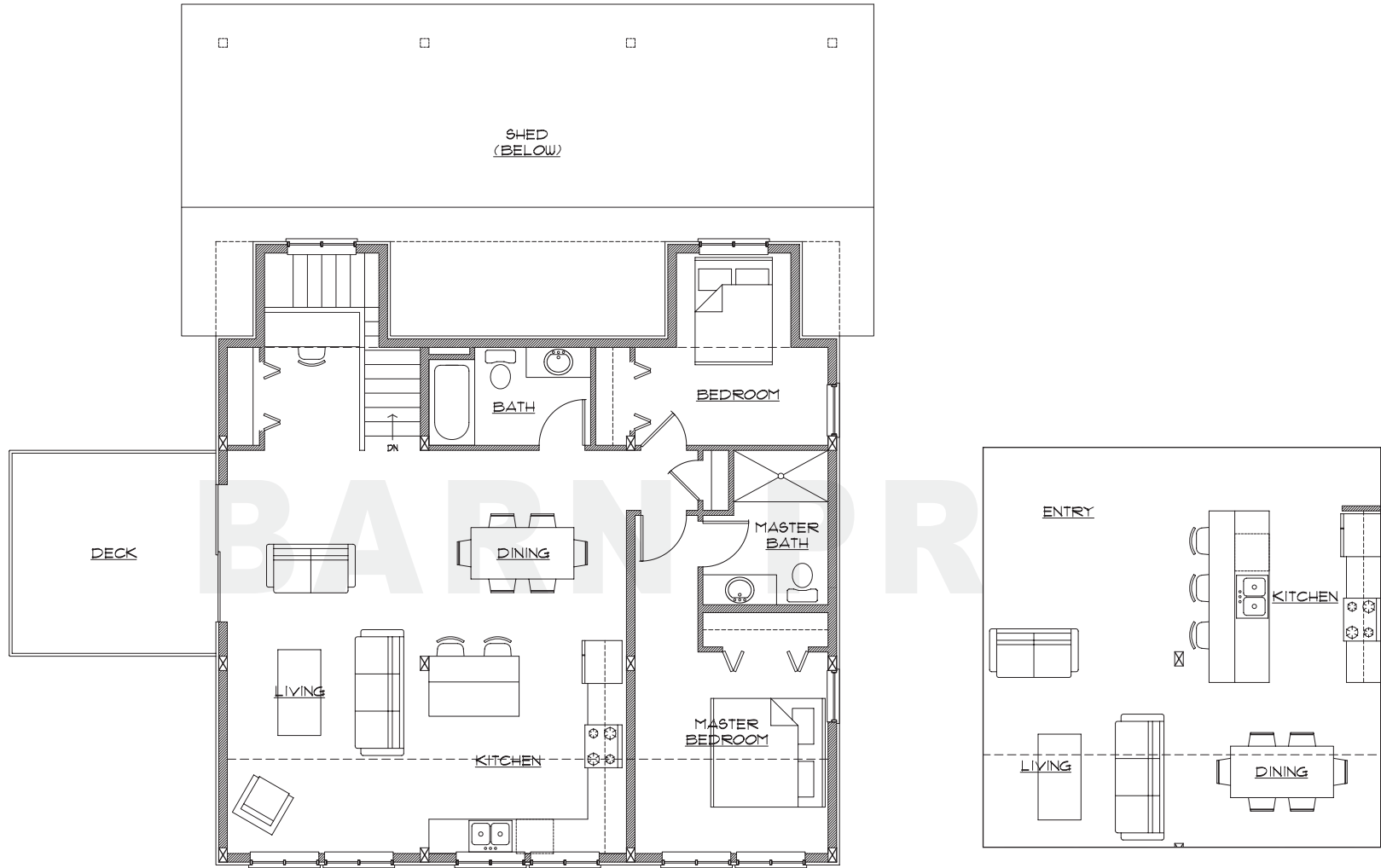

PROPOSED FLOORPLAN - UPPER
Model A Option 1 (left), Option 2 (right)

© 2016 BARN PROS INC

BARN PROS[®]

NATIONWIDE

DENALI 36 BARN APARTMENT

Model B - front



© 2016 BARN PROS INC

Request a **FREE** Denali Apartment e-brochure. Call: **1-866-844-2276**

WWW.BARNPROS.COM • 5 OF 10

BARN PROS[®]

NATIONWIDE

DENALI 36 BARN APARTMENT

Model B - rear



© 2016 BARN PROS INC

Request a **FREE** Denali Apartment e-brochure. Call: **1-866-844-2276**

WWW.BARNPROS.COM • 6 OF 10

Barn Pros Denali 36 Apartment Barn Model B - Standard



Front Elevation



Side Elevation, Left



Rear Elevation



Side Elevation, Right

© 2016 BARN PROS INC

Barn Pros Denali 36 Apartment Barn Model B - Standard

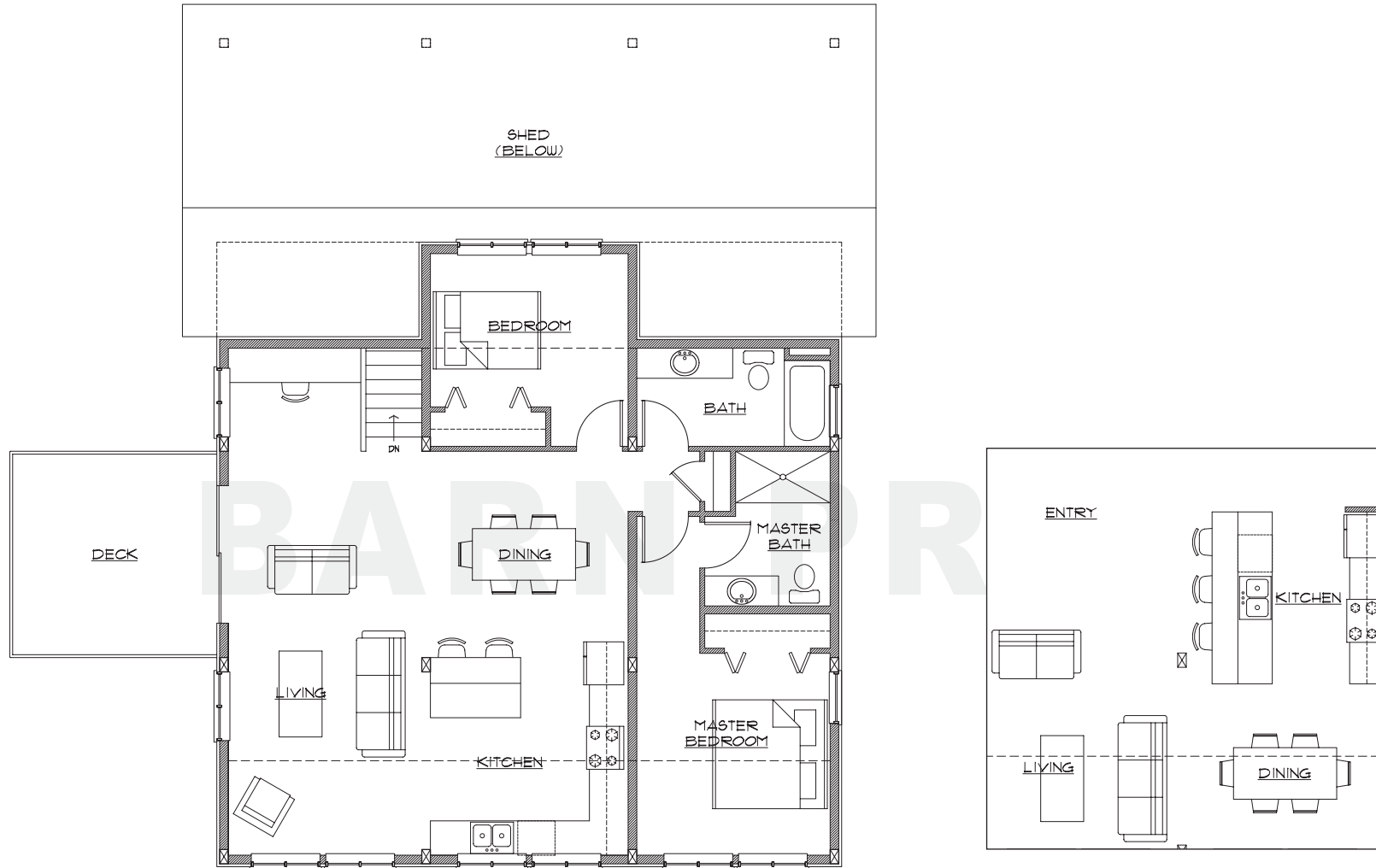

PROPOSED FLOORPLAN - UPPER
Model B Option 1 (left), Option 2 (right)

© 2016 BARN PROS INC

Barn Pros Denali 36 Apartment Barn Standard

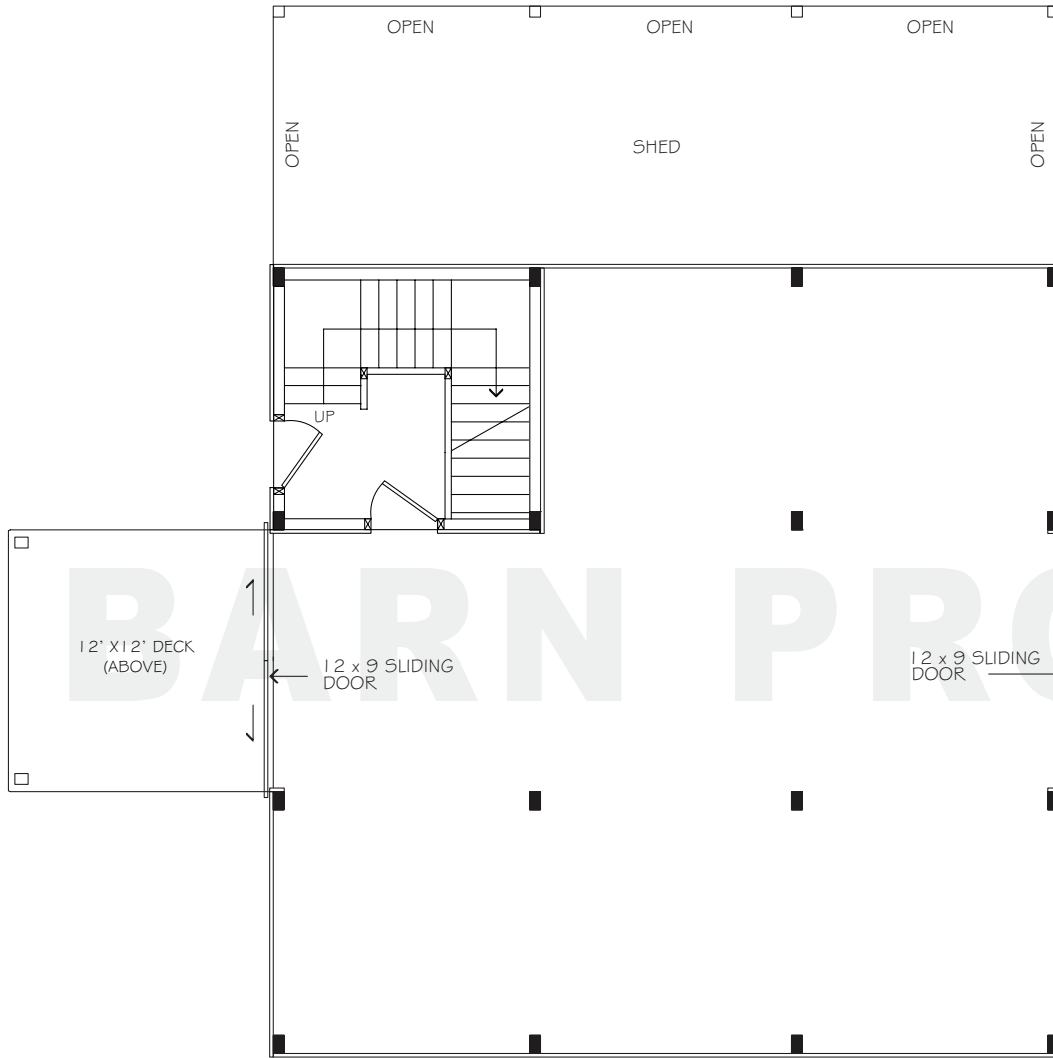

FLOORPLAN - LOWER

© 2016 BARN PROS INC

BARN PROS[®]

NATIONWIDE



Free Denali Apartment e-brochure

Receive a complimentary e-brochure with additional floor plan layouts, detailed model information including drawings and kit specifications, structural elevations, photos, pricing and more.

Call: **1(866)844-2276**

Request your copy of this free brochure today!

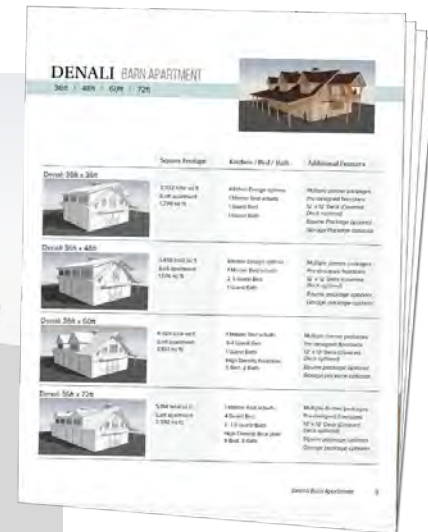

Receptor Proximity

Colitas Farms

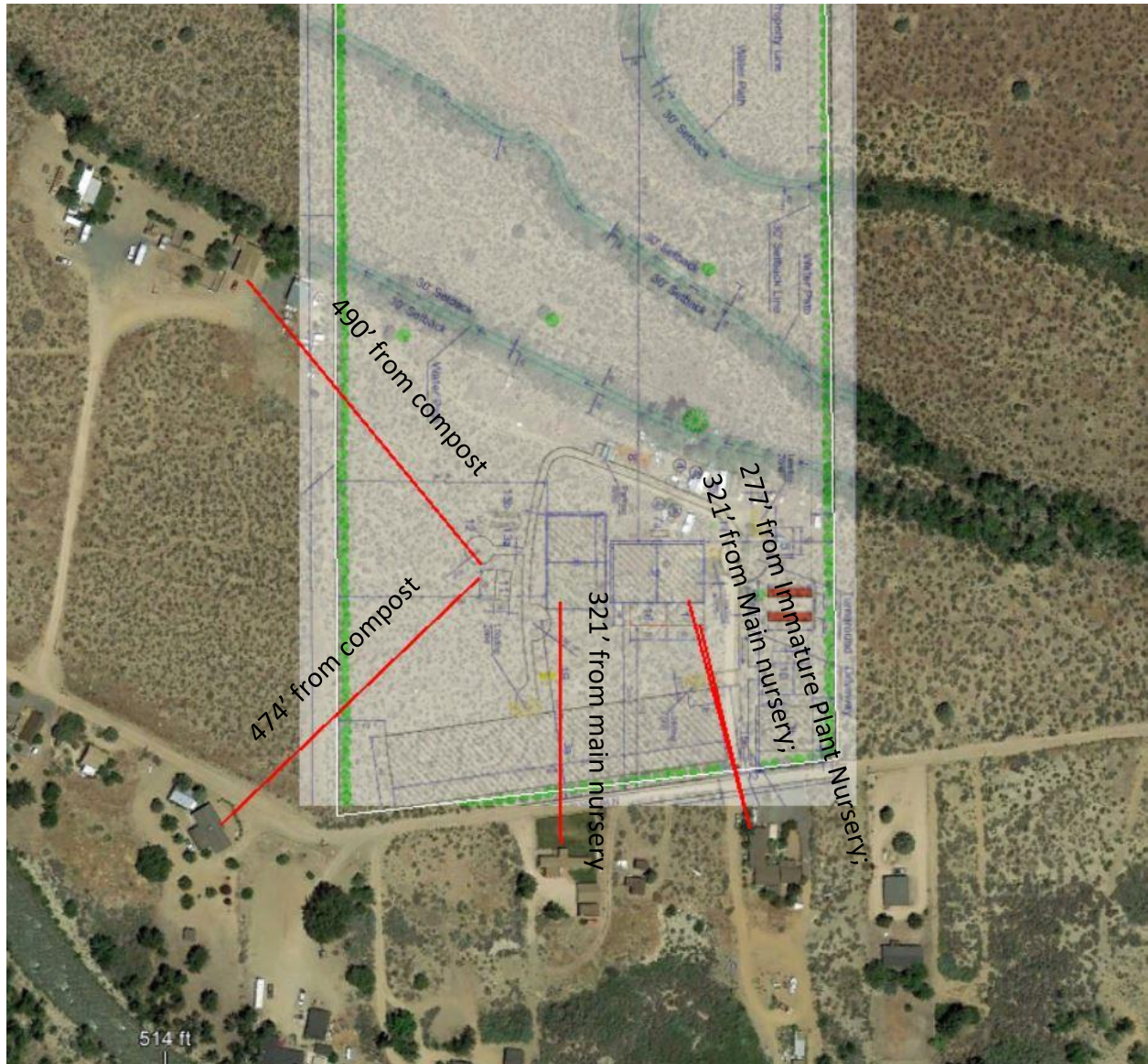

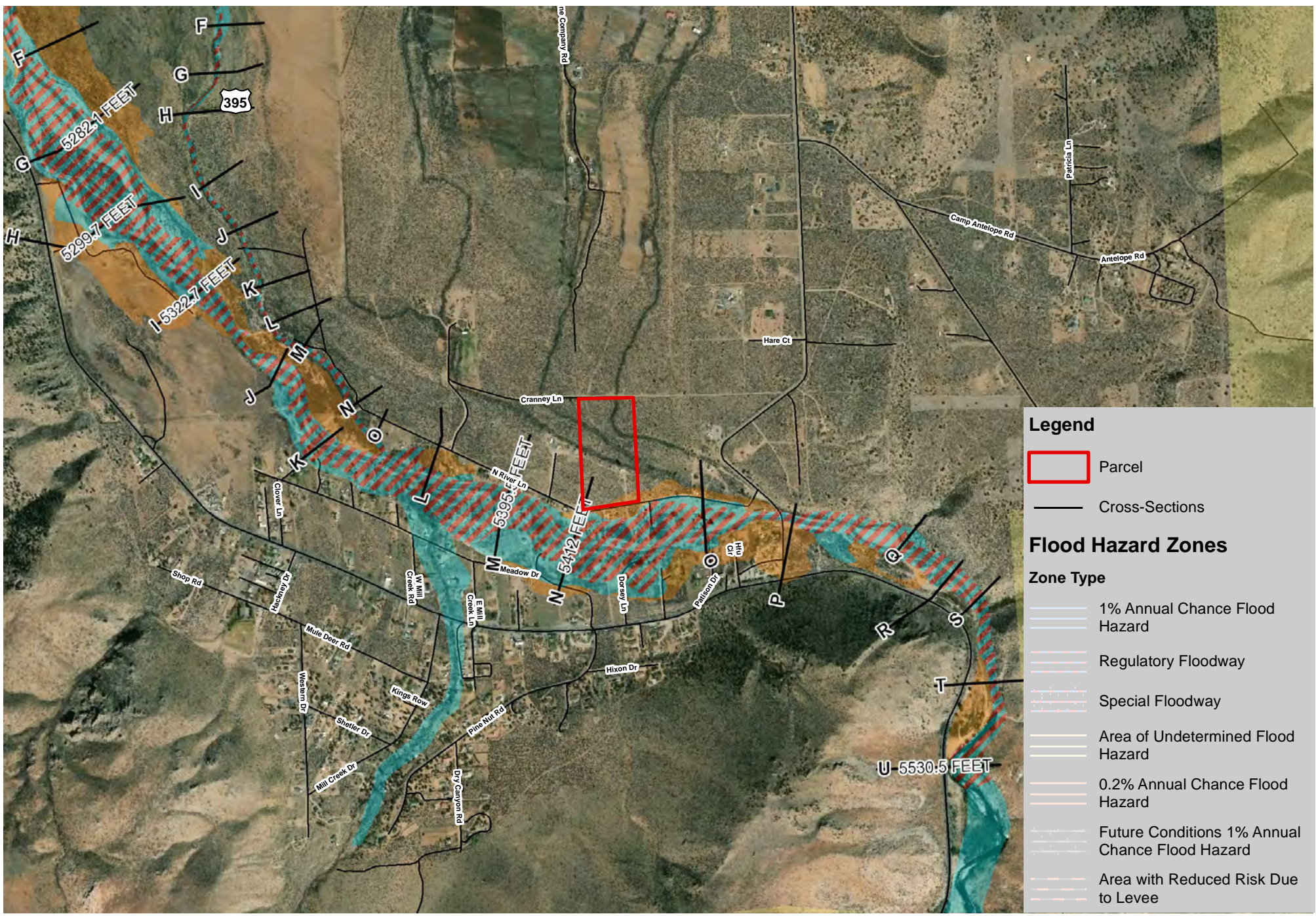

Legend

- Parcel
- Cross-Sections

Flood Hazard Zones

Zone Type

- 1% Annual Chance Flood Hazard
- Regulatory Floodway
- Special Floodway
- Area of Undetermined Flood Hazard
- 0.2% Annual Chance Flood Hazard
- Future Conditions 1% Annual Chance Flood Hazard
- Area with Reduced Risk Due to Levee

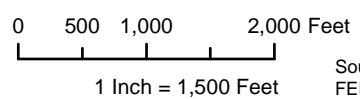

Source:
FEMA's National Flood Hazard Layer (NFHL)

Colitas Farms FEMA Flood Map

6/21/2019

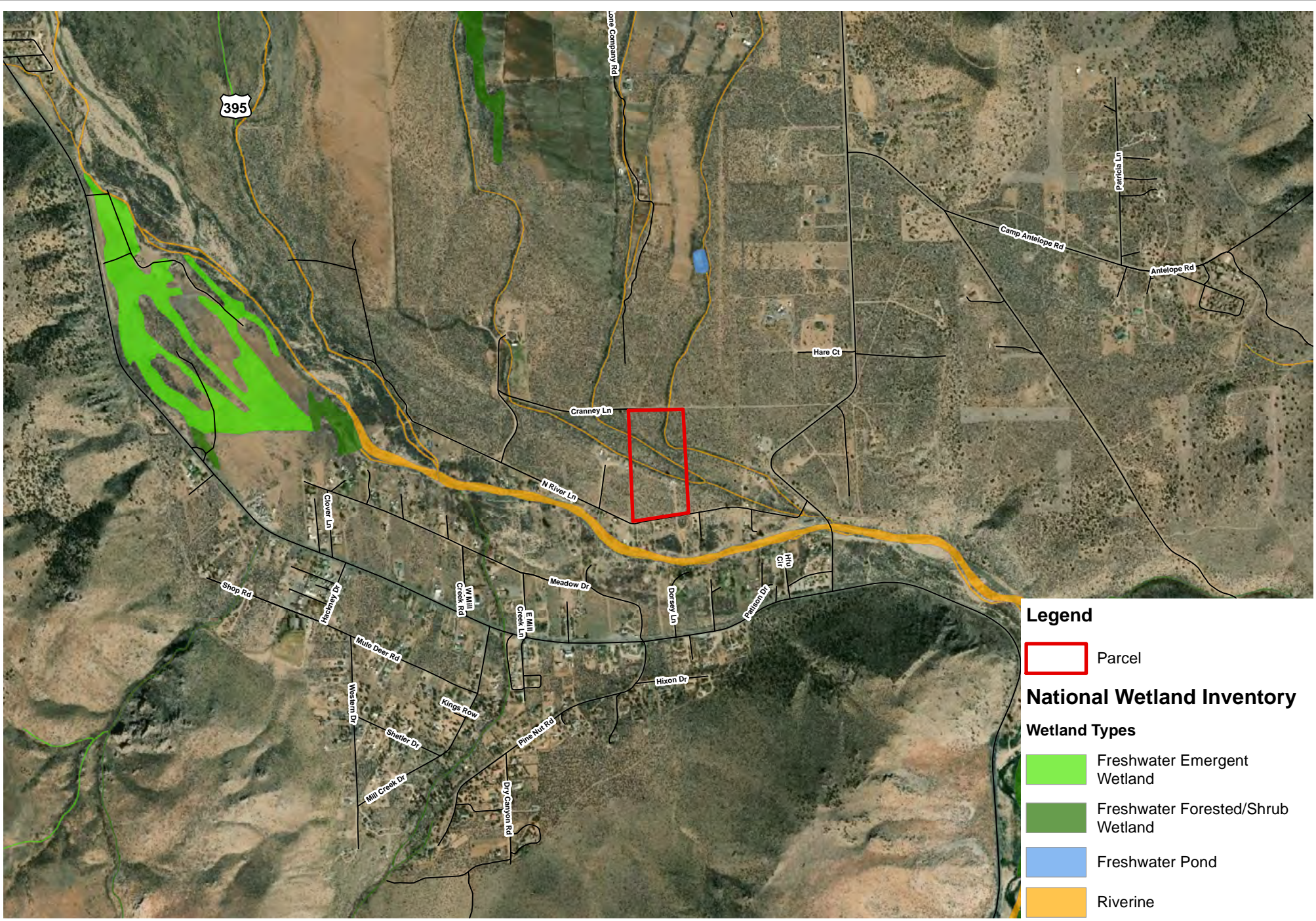

Legend

- Parcel

National Wetland Inventory

Wetland Types

- Freshwater Emergent Wetland
- Freshwater Forested/Shrub Wetland
- Freshwater Pond
- Riverine

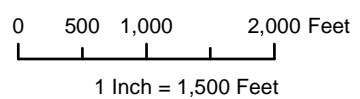

Colitas Farms National Wetland Inventory Map

Document Path: R:\projects\Colitas_Farms\19_604_1\MXD\Colitas_Farms_NWI_Map.mxd

Attachment B

Integrated Pest Management Plan

PEST MANAGEMENT PLAN

OUTDOOR/GREENHOUSE CANNABIS CULTIVATION

FACILITY

PHYSICAL LOCATION

COLITAS FARMS
324 NORTH RIVER LANE
COLEVILLE, CA 96107

MAILING ADDRESS

COLITAS FARMS
13900 NW PASSAGE #210
MARINA DEL REY, CA 90292

PEST MANAGEMENT PLAN

COLITAS FARMS PLANS ON TAKING A HOLISTIC APPROACH TO CANNABIS FARMING

Listed below are five plant treatment protocols that are examples of effective techniques used in a holistic integrative pest management plan:

- **Coconut water** contains cytokinins that aid in cell division, helping plants mend and grow due to healthy cell division.
- **Indigenous microbe inoculations** allow for more resilient plants that are better prepared to fend off pathogens.
- **Powdered potassium silicate** applied as a foliar feed helps stimulate the plant's natural defense methods against fungal attacks and other pathogens.
- **Neem cake** added to the soil mix acts to discourage egg-laying insects in the rhizosphere. It effectively ends problems like fungus gnats while allowing beneficial microbes to flourish.
- **Essential oils** help activate natural defense mechanisms while disrupting the offending pest and preventing it from taking advantage of chemical imbalances.
- **Aloe vera flakes** aid a plant's immune response and pathogen defense.

PEST MANAGEMENT PRACTICES FOR CANNABIS GROWN OUTDOORS

PEST	DAMAGE	IPM PRACTICES (monitoring; cultural, physical, mechanical, biological)	PESTICIDES
MITES & INSECTS			
two-spotted spider mites <i>Tetranychus urticae</i> (and other Tetranychidae)	Suck plant sap; stipple leaves	<ul style="list-style-type: none"> ▪ Keep dust down by hosing off plants (if dust is a problem) ▪ Release predatory mites 	neem oil, horticultural oil
broad mites <i>Polyphagotarsonemus latus</i>	Distort leaves and buds	<ul style="list-style-type: none"> ▪ Inspect plants; disinfest or dispose of infested plants ▪ Release predatory mites and sixspotted thrips 	—
russet mites <i>Aculops</i> spp.	Suck plant sap; kill leaves and flowers	<ul style="list-style-type: none"> ▪ Release predatory mites 	neem oil, horticultural oil, sulfur
crickets (field & house)	Eat seedlings	<ul style="list-style-type: none"> ▪ Use floating row covers or cones on individual plants 	—
termites	Eat roots	<ul style="list-style-type: none"> ▪ Flood nests 	—
leafhoppers	Suck plant sap; weaken plants	<ul style="list-style-type: none"> ▪ Encourage natural enemies by planting nectar sources 	horticultural oil or insecticidal soaps for nymphs
whiteflies <i>Trialeurodes vaporariorum</i> , <i>Bemisia tabaci</i> , <i>B. argentifolii</i>	Suck plant sap; weaken plants	<ul style="list-style-type: none"> ▪ Hang up yellow sticky cards ▪ Use reflective plastic mulch 	azadirachtin, horticultural oil, insecticidal soaps, rosemary + peppermint oils, <i>Beauveria bassiana</i>
thrips <i>Heliethrips haemorrhoidalis</i> , <i>Frankliniella occidentalis</i> , <i>Thrips tabaci</i>	Stipple and scar leaves ; vector viruses	<ul style="list-style-type: none"> ▪ Hang up yellow or blue sticky cards 	horticultural oil, insecticidal soaps, rosemary + peppermint oils, <i>Beauveria bassiana</i>
aphids <i>Myzus persicae</i> , <i>Aphis fabae</i>	Suck plant sap; weaken plants	<ul style="list-style-type: none"> ▪ Hang up yellow sticky cards (alates) ▪ Hose off plants 	azadirachtin, horticultural oil, insecticidal soaps, <i>Beauveria bassiana</i>
leafminers <i>Liriomyza</i> spp.	Bore into roots and leaves	<ul style="list-style-type: none"> ▪ Remove older infested leaves ▪ Use biocontrol: release <i>Diglyphus parasitoids</i> 	azadirachtin

PEST		DAMAGE	IPM PRACTICES (monitoring; cultural, physical, mechanical, biological)	PESTICIDES
LEPIDOPTERA	cutworms <i>Agrotis ipsilon</i> , <i>Spodoptera exigua</i> (Noctuidae)	Eat seedlings	<ul style="list-style-type: none"> ▪ Use pheromone traps to detect adults. ▪ Remove weeds, which serve as a reservoir for cutworms and other noctuids 	Vegetative stage only: Use <i>Bacillus thuringiensis kurstaki</i> if egg-laying adults found, insecticidal soap; azadirachtin
	budworms <i>Helicoverpa zea</i> (Noctuidae)	Eat flowering buds	<ul style="list-style-type: none"> ▪ Shake plants to dislodge larvae ▪ Remove infested buds ▪ Plant corn as trap crop 	Vegetative stage only: Use <i>Bacillus thuringiensis kurstaki</i> , insecticidal soap
COLEOPTERA	flea beetles (Chrysomelidae)	Bore into stems (grubs); feed on seedlings and leaves of larger plants (adults)	<ul style="list-style-type: none"> ▪ Use reflective mulches ▪ Plant trap crops (e.g., radish or Chinese mustard) 	sulfur
	scarab grubs (Scarabaeidae) possibly other beetles)	Bore into stems	<ul style="list-style-type: none"> ▪ Use parasitic nematodes 	—
MAMMALS				
mice (e.g., house mice)	Eat young sprouts and seeds	<ul style="list-style-type: none"> ▪ Double wrap a 3'-tall chicken wire fence around plants ▪ Trap (minus rodenticides) ▪ Mount barn owl boxes 	rodenticides*	
roof rats, <i>Rattus rattus</i> wood rats, <i>Neotoma</i> spp.	Strip bark from stems to build nests			
pocket gophers, <i>Thomomys</i> spp.	Tunnel through planting areas; feed on plants; gnaw on irrigation lines			
Columbian black-tailed deer, <i>Odocoileus hemionus columbianus</i>	Knock over plants; leave dander, droppings, and ticks behind	<ul style="list-style-type: none"> ▪ Install deer fencing 	—	
black bears, <i>Ursus americana</i>	Knock over plants	<ul style="list-style-type: none"> ▪ Install electric fencing 	—	

* If using a rodenticide always read and follow the label and check to make sure that the target rodent is listed. Second-generation anticoagulant products (contain the active ingredients brodifacoum, bromadiolone, difenacoum, and difethialone) are DPR-restricted materials not labeled for field use and should never be used in or around cannabis cultivation sites. Permits for the use of DPR-restricted materials will not be issued to cannabis cultivators. Any federally restricted use pesticide must be applied by a certified applicator consistent with the registered labeling.

PEST MANAGEMENT PRACTICES FOR CANNABIS GROWN INDOORS

(e.g., greenhouses, sheds, and grow rooms)

PEST	DAMAGE	IPM PRACTICES (monitoring; cultural, physical, mechanical, biological)	PESTICIDES
DISEASES			
powdery mildew <i>Sphaerotheca macularis</i>	Grow on leaves as white and gray powdery patches	<ul style="list-style-type: none"> Use fans to improve air circulation 	horticultural oil; neem oil; sodium bicarbonate, potassium bicarbonate; <i>Bacillus subtilis</i>
pythium root rots <i>Pythium</i> spp.	Attack root tips and worsens when plants grow in wet soil	<ul style="list-style-type: none"> Avoid hydroponic production or wet soil conditions 	Incorporate biocontrol agents into root-growing media (e.g., <i>Gliricium virens</i> , <i>Trichoderma harzianum</i> , <i>Bacillus subtilis</i>)
MITES & INSECTS			
two-spotted spider mites <i>Tetranychus urticae</i> (and other Tetranychidae)	Suck plant sap; stipple leaves	<ul style="list-style-type: none"> Disinfest cuttings before introducing to growing area Release predatory mites (<i>Amblyseius</i> spp., <i>Phytoseiulus persimilis</i>), or lacewings (<i>Chrysoperia</i> spp.) 	neem oil, horticultural oil, sulfur
broad mites	Distort leaves and buds	<ul style="list-style-type: none"> Inspect plants; disinfest or dispose of infested plants Release predatory mites (<i>Amblyseius</i> spp.) and six-spotted thrips 	
leafhoppers	Suck plant sap; weaken plants	<ul style="list-style-type: none"> Encourage natural enemies by planting nectar sources 	horticultural oil or insecticidal soaps for nymphs
whiteflies <i>Trialeurodes vaporariorum</i> , <i>Bemisia tabaci</i> , <i>B. argentifolii</i>	Suck plant sap; weaken plants	<ul style="list-style-type: none"> Hang up yellow sticky cards Use biocontrol: <i>Amblyseius swirskii</i>, <i>Encarsia formosa</i>, <i>Delphastus catalinae</i>, <i>Steinernia feltiae</i> 	azadirachtin, <i>Beauveria bassiana</i> , cinnamon oil, horticultural oil
thrips <i>Heliethrips haemorrhoidalis</i> , <i>Frankliniella occidentalis</i> , <i>Thrips tabaci</i>	Stipple and scar leaves ; vector viruses	<ul style="list-style-type: none"> Sterilize soil and pots before growing Hang up yellow or blue sticky cards Use biocontrol <i>Stratiolaelaps scimitus</i>, <i>Amblyseius cucumeris</i>, <i>Amblyseius swirskii</i>, <i>Orius insidiosus</i> 	azadirachtin, horticultural oil, insecticidal soaps, rosemary + peppermint oils, <i>Beauveria bassiana</i>

PEST	DAMAGE	IPM PRACTICES (monitoring; cultural, physical, mechanical, biological)	PESTICIDES
rice root aphid <i>Rhopalosiphum rufiabdominalis</i>	Feed on roots; stunt and weaken plants	<ul style="list-style-type: none"> ▪ Dispose of weakened infested plants ▪ Mix in sharp soil amendments such as diatomaceous earth ▪ Use biocontrol: <i>Stratiolaelaps scimitus</i>, <i>Dalotia coriaria</i>, <i>Steinernema feltiae</i> 	<i>Beauveria bassiana</i>
dark-winged fungus gnats (Diptera: Sciaridae) <i>Bradysia</i> spp.	Damage roots and stunt plant growth	<ul style="list-style-type: none"> ▪ Avoid overwatering ▪ Use growing media that deters gnat development ▪ Hang up yellow sticky cards ▪ Use biocontrol: <i>Stratiolaelaps scimitus</i>, <i>Dalotia coriaria</i>, <i>Steinernema feltiae</i> 	<i>Bacillus thuringiensis israelensis</i> (BTI); predatory nematodes; azadirachtin soil drenches

Attachment C

Waste Management Plan

WASTE MANAGEMENT PLAN

OUTDOOR/GREENHOUSE CANNABIS CULTIVATION

FACILITY

PHYSICAL LOCATION

COLITAS FARMS
324 NORTH RIVER LANE
COLEVILLE, CA 96107

MAILING ADDRESS

COLITAS FARMS
13900 NW PASSAGE #210
MARINA DEL REY, CA 90292

WASTE MANAGEMENT PLAN

COLITAS FARMS WILL TAKE A HOLISTIC, NATURAL APPROACH TO FARMING CANNABIS. THE MAJORITY OF ANY CANNABIS WASTE THAT WILL BE CREATED ON OUR FARM WILL BE RECONSTITED INTO THE GROWING PROCESS IN AN ON SITE COMPOST HEAP. IF THERE IS ANY ADDITIONAL WASTE THAT WE CANNOT USE IN OUR GROWING PROCESS WE WILL SELF HAUL TO A MANNED FULLY PERMITTED SOLID WASTE LANDFILL OR TRANSFORMING FACILITY.

OUR MASTER GROWER/FARM MANGER WILL BE IN CHARGE OF MAINTIANING AND PROCESSING THE WASTE INTO USABLE COMPOST AND SCHEDULING ANY SELF HAULING OF WASTE THAT MAY ON OCCATION NEED TO BE MOVED TO A PERMITTED WASTE SITE OFF OF OUR PROPERTY.

Attachment D

Lahontan Regional Water Quality Control Board Letter



EDMUND G. BROWN JR.
GOVERNOR

MATTHEW RODRIGUEZ
SECRETARY FOR
ENVIRONMENTAL PROTECTION

Lahontan Regional Water Quality Control Board

December 18, 2018

WDID No. 6T26CC405729

Jennifer Pearsons
Colitas Farms LLC
13900 Northwest Passage Apt 210
Marina Del Rey, CA 90292

Michael Storc
13900 Northwest Passage Apt 210
Marina del Rey, CA 90292

SUBJECT: NOTICE OF APPLICABILITY - WASTE DISCHARGE REQUIREMENTS, WATER QUALITY ORDER NO. WQ-2017-0023-DWQ, COLITAS FARMS LLC, MONO COUNTY - APN 002460015000, WDID NO. 6T26CC405729

EXPIRATION DATE: NOVEMBER 30, 2019

Dear Ms. Pearsons and Mr. Storc,

Colitas Farms LLC (hereafter Discharger) submitted information via the State Water Resources Control Board's (State Water Board's) online portal on October 29, 2018, for discharges of waste associated with outdoor cannabis cultivation related activities at 324 North River Lane, Coleville (38.518641°N, 119.464742°W). The State Water Board received the associated application fee on November 30, 2018, and subsequently transferred site information to us for processing.

The property is also owned by Jennifer Pearsons and Michael Storc. Each landowner is ultimately responsible for any water quality degradation that occurs on or originates from their property and for water diversions that are not in compliance with the State Water Board's *Cannabis Cultivation Policy- Principles and Guidelines for Cannabis Cultivation (Policy)* and *General Waste Discharge Requirements and Waiver of Waste Discharge Requirements for Discharges of Waste Associated with Cannabis Cultivation Activities*, Order No. WQ-2017-0023-DWQ (General Order).

Based on the information provided, the Discharger self-certifies the cannabis cultivation activities are consistent with the Policy and General Order. This letter provides notice that the Policy and General Order are applicable to the site as described below. You are hereby assigned waste discharge identification (WDID) No. 6T26CC405729. The Discharger is responsible for all the applicable requirements in the Policy, General Order, this Notice of Applicability (NOA), and for acquiring additional certifications and permits as needed (see SITE-SPECIFIC REQUIREMENTS below for guidance).

FACILITY AND DISCHARGE DESCRIPTION

The information submitted by the Discharger states the disturbed area is equal to or greater than 1 acre (43,560 square feet), no portion of the disturbed area is within the setback requirements, and no portion of the disturbed area is located on a slope greater than 30 percent. Based on the information submitted by the Discharger, the cannabis cultivation activities are classified as Tier 2, Low Risk outdoor cultivation.

SITE-SPECIFIC REQUIREMENTS

1. The Policy and General Order are available on the Internet at: https://www.waterboards.ca.gov/water_issues/programs/cannabis. The Discharger shall ensure that all site operating personnel know, understand, and comply with the requirements contained in the Policy, General Order, this NOA, and the Monitoring and Reporting Program (MRP, Attachment B of the General Order). Note that the General Order contains standard provisions, general requirements, and prohibitions that apply to all cannabis cultivation activities.
2. The Discharger shall notify Water Boards staff in writing of any proposed change in the method of wastewater disposal.
3. The application requires the Discharger to self-certify that all applicable Best Practicable Treatment or Control (BPTC) measures are being implemented, or will be implemented by the onset of the winter period (October 15-May 1 above 6,000 feet and November 15 – April 1, for cultivation sites at or below 6,000 feet), following the enrollment date. Dischargers that cannot implement all applicable BPTC measures by the onset of the winter period, following their enrollment date, shall submit to the appropriate Regional Water Board a *Site Management Plan* that includes a time schedule and scope of work for use by the Regional Water Board in developing a compliance schedule as described in Attachment A of the General Order.
4. The Discharger shall permit representatives of the Regional Water Board and/or the State Water Board, upon presentation of credentials, to:
 - i. Enter premises where cannabis is cultivated or processed, wastes are treated, stored, or disposed of, and facilities in which any records are kept.
 - ii. Copy any records required under terms and conditions of the General Order.
 - iii. Inspect at reasonable hours, monitoring equipment required by this General Order (as applicable).
 - iv. Sample, photograph, and/or video record any cultivation activity, discharge, waste material, waste treatment system, or monitoring device.
5. Water quality certification or waste discharge requirements may be required in accordance with either the Clean Water Act or the Porter Cologne Water Quality Control Act for any proposed excavation, fill, or dredging activities in surface waters. Examples include, but are not limited to, stream crossings, installation or replacement of culverts, and stream diversions. Additional information is located at: https://www.waterboards.ca.gov/lahtontan/water_issues/programs/clean_water_act_401.

6. Land disturbance of one acre or more not directly related to cultivation (i.e., infrastructure-related) may require coverage under the General Board Order No. 2009-0009-DWQ. Example activities include, but are not limited to, road construction, stream diversion, and building installation. See:
https://www.waterboards.ca.gov/lahontan/water_issues/programs/storm_water for details.

TECHNICAL REPORT REQUIREMENTS

The following technical report(s) shall be submitted by the Discharger as described below:

1. A *Site Management Plan* must be submitted by **January 26, 2019**, consistent with the requirements of General Order Provision C.1.a., and Attachment A, Section 5. Attachment D of the General Order provides guidance on the contents of the *Site Management Plan*.
2. A *Nitrogen Management Plan* must be submitted by **January 26, 2019**, consistent with the requirements of General Order Provision C.1.d., and Attachment A, Section 5. Attachment D of the General Order provides guidance on the contents of the *Nitrogen Management Plan*.
3. A *Site Closure Report* must be submitted 90 days prior to permanently ending cannabis cultivation activities and seeking to rescind coverage under the General Order. The *Site Closure Report* must be consistent with the requirements of General Order Provision C.1.e., and Attachment A, Section 5. Attachment D of the General Order provides guidance on the contents of the *Site Closure Report*.

MONITORING AND REPORTING PROGRAM

The Discharger shall comply with the Monitoring and Reporting Program (MRP). Attachment B of the General Order provides guidance on the contents for the annual reporting requirement. Annual reports shall be submitted to the Regional Water Board by **March 1** following the year being monitored. The Discharger shall not implement any changes to this MRP unless and until a revised MRP is issued by the Regional Water Board Executive Officer or the State Water Board Division of Water Quality Deputy Director, or the State Water Board Chief Deputy Director.

ANNUAL FEE

According to the information submitted, the discharge is classified as Tier 2, Low Risk, with the current annual fee assessed at \$1,000. The fee is due and payable on an annual basis until coverage under this General Order is formally rescinded. To rescind coverage, the Discharger must submit a Notice of Termination, including a *Site Closure Report* at least 90 days prior to termination of activities and include a final MRP report.

TERMINATION OF COVERAGE UNDER THE GENERAL ORDER & REGIONAL WATER BOARD CONTACT INFORMATION

Cannabis Dischargers that propose to terminate coverage under the Conditional Waiver or General Order must submit a Notice of Termination (NOT). The NOT must include a *Site Closure Report* (see Technical Report Requirements above), and Dischargers enrolled under the General Order must also submit a final monitoring report. The Regional Water Board reserves the right to inspect the site before approving a NOT. Attachment C of the General Order includes the NOT form, and Attachment D of the General Order provides guidance on the contents of the *Site Closure Report*.

Please notify us 30 days prior to commencing cultivation. Please direct all submittals, discharge notifications, and questions regarding compliance and enforcement to our office. We can be emailed at lahontan.cannabis@waterboards.ca.gov. Phone calls may be directed to me at (530) 542-5414 (patty.kouyoumdjian@waterboards.ca.gov) or Emily Cushman, Engineering Geologist, at (530) 542-5598 (emily.cushman@waterboards.ca.gov).

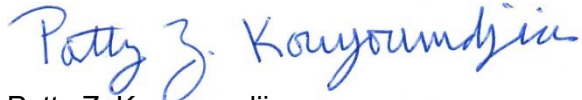

Patty Z. Kouyoumdjian
Executive Officer
Lahontan Regional Water Quality Control Board

cc: Louis Molina, Mono Environmental Health Department
Michael Draper, Planning Analyst, Mono County Community Development Department
Claire Ingel, Environmental Scientist, CA Department of Fish and Wildlife
Kevin Porzio, Senior Water Resource Control Engineer, Department of Water Quality,
State Water Resources Control Board
Emily Cushman, Engineering Geologist, Lahontan Regional Water Quality Control Board

Attachment E

Odor Mitigation Plan



Table of Content

Page 1:	Introduction of NCM services
Page 2-3:	Proposed odor control plan
Page 4:	Overhead Map
Page 5-8:	Cut sheet and photos of recommended vapor odor control system
Page 9-10:	Cut sheet and photo of Exhaust vent misting system
Page 11:	Cut sheet for HVAC odor control treatment



NCM Environmental Solutions goal is to provide the cannabis industry with company that will aid our clients from seed to sale and/or planning to operating phases by providing state of the art modeling and consulting services to evaluate the localized impacts of odors generated at cannabis operating facilities.

NCM specializes in odor control. Our parent company has over 25 years experience in designing and manufacturing odor control neutralizers at our manufacturing plant. Our neutralizer has two active parts of the product that play key roles in the neutralization of the malodors, fragrance and Metazene®. Metazene® is an odor neutralizing compound that directly interacts with malodors. Typical malodors, such as 'cannabis', 'fishy', 'putrid', or 'rancid', are made up of highly volatile aromatic compounds, meaning they tend to be the first aromas that you smell. Metazene® reacts with these compounds to form a complex ion that acts like a net to surround and envelopes the malodor. This complex ion becomes 'heavy' and less volatile resulting in the neutralization of the malodor. The fragrance is an odor masker. It is made up of various essential oils and nature identical aroma chemicals as well as some solvents to increase tenacity and longevity.

NCM also custom designs, installs and services odor control dispersion systems designed to disperse our neutralizer & neutralize odors before they become a nuisance. In addition to manufacturing neutralizers and delivery systems NCM offers modeling & consulting services to evaluate the localized impacts of odors generated at cannabis growing operations as well as dispensaries and facilities handling cannabis.

By implanting the proposed modeling services, odor control system and neutralizer our clients and municipalities will ensure that it is taking state of the art measures once only available in the waste industry to identify the dispersion of odors and implement the best practices to neutralize them.

To whom it May Concern.

The designed odor control plan is meant to ensure the proposed Marijuana Facility is following: Chapter 13 / Section 13.070 General Standards and Requirements section E. **Odor Control**.

Section E / 1 states:

“An odor mitigation plan is required to demonstrate that odors generated by the commercial cannabis activity shall not unreasonably impact adjacent properties and uses, or that odor mitigation measures are not applicable due to lack of cannabis related odor generation, location, or siting, design features or other factors.

Section E / 2 states: An odor mitigation plan shall ensure that cannabis odors are mitigated outside of the facility; on adjacent property or public right of way; on or about the exterior or interior common area walkways, hallways, breezeways, foyers, lobby areas, or any other areas available for use by common tenants or visiting public; or within any other unit located inside the same building as a commercial cannabis activity, and may include the following:

- i. Odor-control filtration and ventilation system(s) to control odors;
- ii. Devices and/or techniques incorporated into the facility or premise to mitigate the off-site detection of Cannabis odors.

https://monocounty.ca.gov/sites/default/files/fileattachments/planning_division/page/9862/ch. 13.pdf

The proposed cannabis facility will have 3 locations on site that have that could generate odors:

1. Main Greenhouse (Item # 9 on attached overhead view)
2. Second Greenhouse (item #6 on attached overhead view)
3. Drying, Processing & Storage Shed (item # 5 on attached overhead view)

NCM will work with the applicant to design a permanent system once all building layouts are complete. In regard to the outdoor grow area; NCM has designed a multi-zone odor control system. This unit will have 4 zones:

- North
- South
- East
- West

Each zone will be programmed to operate when the wind speed and wind direction variables that are programmed are met. This ensures no odor control product will get on the cannabis plants but more importantly it ensures that odors will be treated when the winds blow away from the plants potentially carrying the odors off site.

The proposed odor control neutralizer that will be dispersed from the selected odor control dispersion systems (once final site plans are chosen) will be used to ensure no fugitive odors escape the proposed location and potentially create a “nuisance” is manufactured in our chemical plant in Pittsburg, PA. Our products come with current SDS (MSDS) documentation.

The proposed odor control systems and products are being used throughout CA at Cannabis facilities as well as waste facilities where we treat odors associated with trash. Below are a few waste industry facilities in CA using our company’s technology and products:

- WM Palmdale Landfill
- City of Los Angeles Transfer Station and Lopez Cyn Landfill
- County of Santa Barbara Compost Yard
- Dublin San Ramon Waste Water Treatment Facility
- City of Los Angeles Hyperion Waste Water treatment plant

On the following pages you will see:

- Brief description of the services and capabilities that NCM offers the Cannabis Industry.
- Overhead layout of the proposed cannabis facility with notes showing where the proposed odor control system maybe located.
- Cut sheets of two recommended odor control systems for the greenhouse area (9, 1, 18 as marked on diagram) as well as processing / drying shed.
- Cut sheets of recommended odor control system for oil extraction shed.

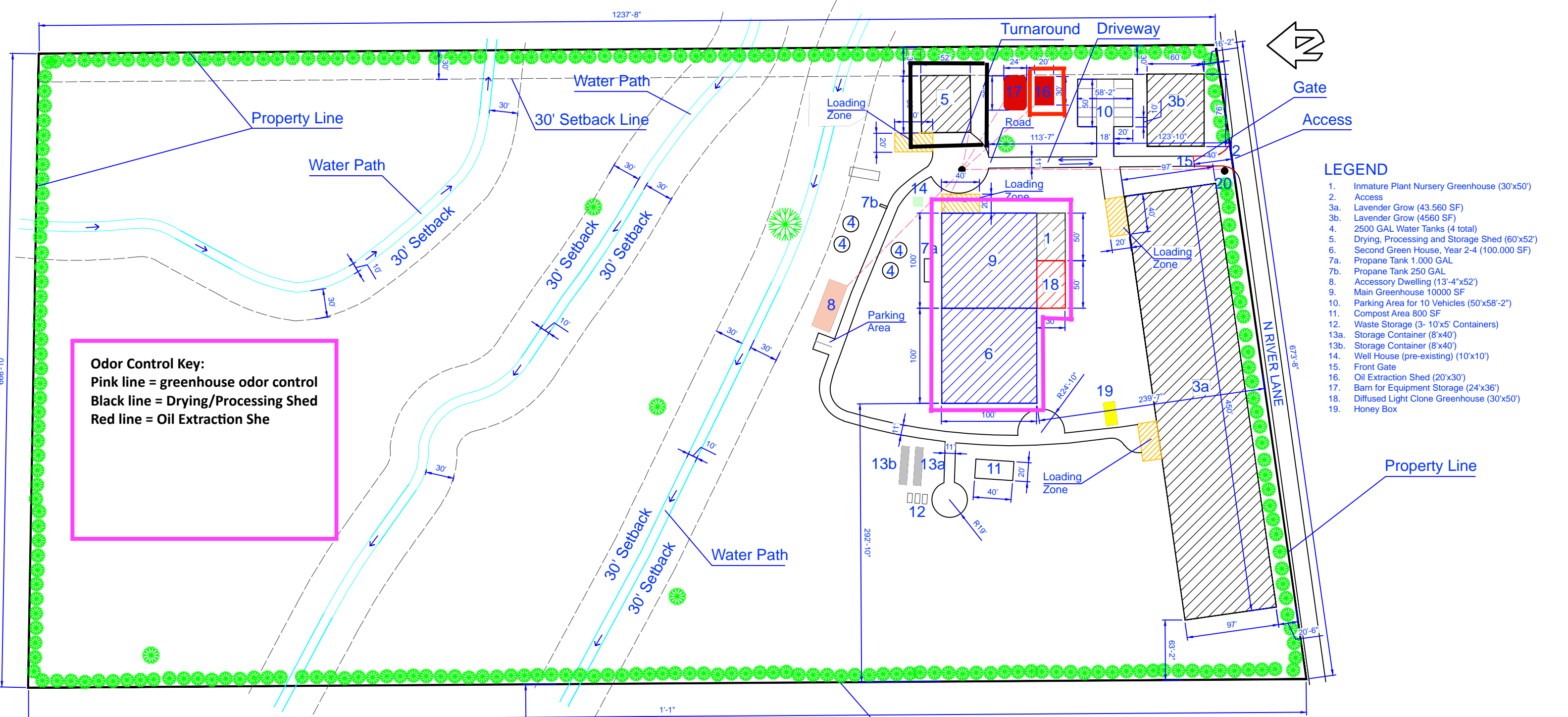

Odor Control Key:
 Pink line = greenhouse odor control
 Black line = Drying/Processing Shed
 Red line = Oil Extraction She

- LEGEND**
1. Inmature Plant Nursery Greenhouse (30'x50')
 2. Access
 - 3a. Lavender Grow (43,560 SF)
 - 3b. Lavender Grow (4560 SF)
 4. 2500 GAL Water Tanks (4 total)
 5. Drying, Processing and Storage Shed (60'x52')
 6. Second Green House, Year 2-4 (100,000 SF)
 - 7a. Propane Tank 1,000 GAL
 - 7b. Propane Tank 250 GAL
 8. Accessory Dwelling (13'-4"x52')
 9. Main Greenhouse 10000 SF
 10. Parking Area for 10 Vehicles (50'x58'-2")
 11. Compost Area 800 SF
 12. Waste Storage (3- 10'x5' Containers)
 - 13a. Storage Container (8'x40')
 - 13b. Storage Container (8'x40')
 14. Well House (pre-existing) (10'x10')
 15. Front Gate
 16. Oil Extraction Shed (20'x30')
 17. Barn for Equipment Storage (24'x36')
 18. Diffused Light Clone Greenhouse (30'x50')
 19. Honey Box



Parcel No. (APN) 002-460-015-000
 Lot Area 816.239 SF
 Total Lot Coverage 118.500 SF 14.5%

**324 N RIVER LN
 COLEVILLE, CA 96107
 Scale: 1"=100'**





Nonaqueous Odor Control Chemicals Delivery System

Nonaqueous Odor Control Chemicals Delivery System (patent pending) is designed by NCM.

Vapor Odor Control System is designed for simplicity, dependability, and ease of operation. O&M requirements for the system are next to nothing comparing to water based systems. The system reliability system is ensured in any weather conditions from hot and humid to dry with freezing temperatures.

The system has been installed and successfully operating to keep our clients in compliance with regulatory odor control requirements throughout the United States.



 NCM Environmental Solutions designs each system to meet clients' site specific needs. Each base station is manufactured based on the site specific design. The site specific design is developed based on the geographic location and climatological conditions, the odor causing area that requires odor control coverage, and facility specific conditions. The system can be developed for enclosed structures, structure ventilation systems, and for large open areas such as a landfill. The service area of the system can vary from a few 100 feet long coverage to 4,000 feet using a single base station.

Odor Control System Description

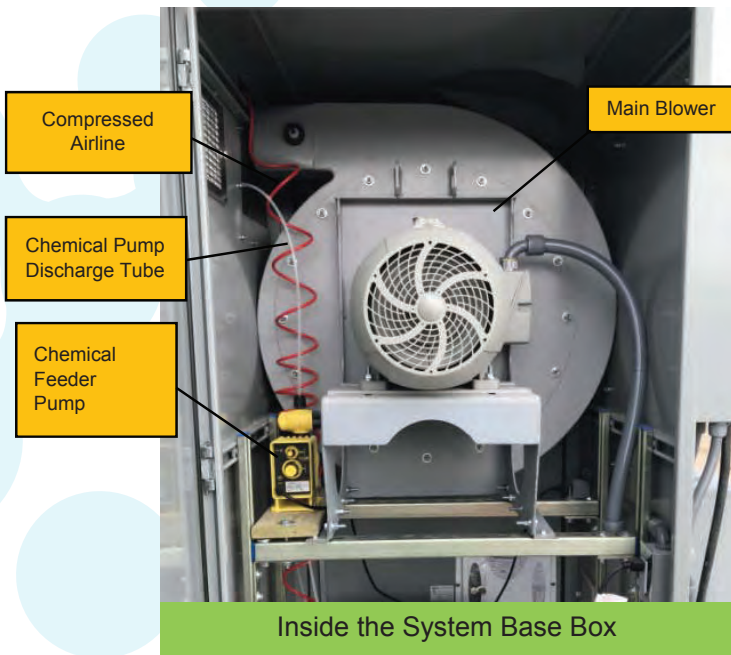

The machine box of the system base station includes a main air blower that supplies up to 1,200 cfm of pressured air. A chemical feeder pump supplies nonaqueous odor control chemical to the main airline using a high pressure (over 100 psi) air through the filter system. The filter system safely mixes the chemical into the main airflow generated by the blower. The amount of chemical supplied depends on the characteristics of the odor control chemical supplied by third parties. An excess chemical recovery sump is incorporated into the design to verify the ability of the odor control chemicals to vaporise. Ambient air pulled by the main blower is filtered to prevent particle build up in the system.

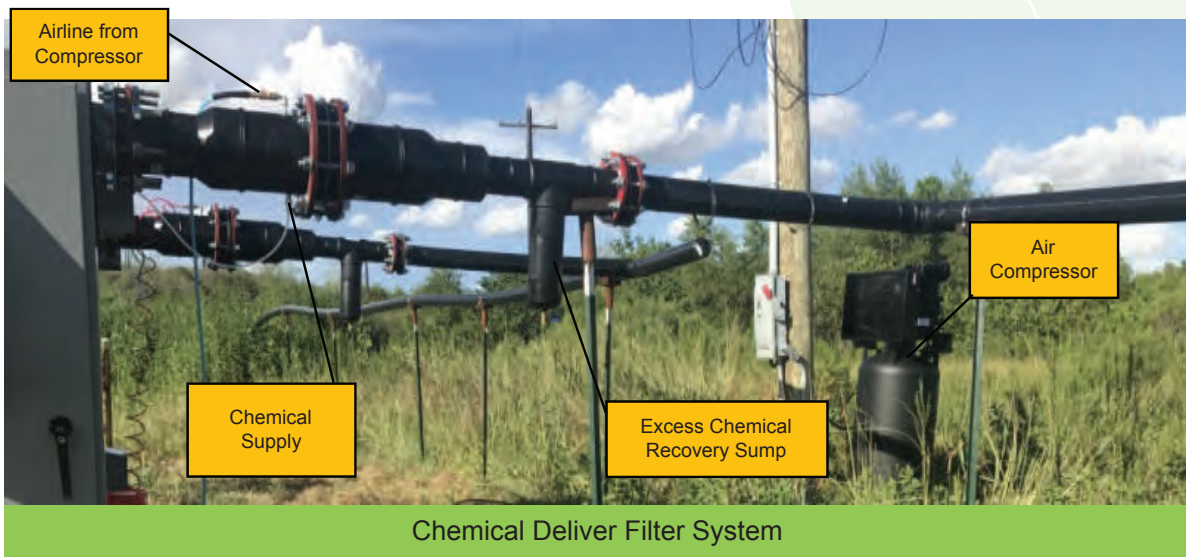

Vapor odor control system on ridge vent when vent is in open position



Vapor Odor Control System on ridge vent in closed position



Product: Odor Control System

Description: Trying to control odors being exhausted out of your greenhouse. This high pressure atomizing odor control system is a cost effective way to control odors. With two decades of experience treating odors in the garbage industry NCM is bringing our technology to the cannabis industry. System is water based and allow end user to mount nozzles to any size exhaust fan and comes with odor control injection pump allowing user to increase or decrease odor control solution as needed.

Standard Equipment:

- Min. 3 high pressure atomizing nozzles
- 110v/115v plug
- High pressure water pump
- Electric motor
- 50 micron bag filter
- Pressure unloaded
- Pressure switch
(protects system if water supply is interrupted)
- 7 day digital programmable timer
- Nema 4 control box

Optional Equipment:

- Solar operation
(includes solar panel and storage batteries)
- Motor start control switch.
Allows user to have odor control system turn on and off automatically as exhaust fan turns on / off.
- Additional nozzles to increase coverage from one exhaust fan to two.
- Additional high pressure hydraulic hose to extend coverage (required if additional nozzles are ordered).



Exhaust Fan Odor Control System



PROFESSIONAL DIFFUSERS FOR
ODOR NEUTRALIZATION AND
AMBIENT SCENTING

ROMASTYLER™
DIFFUSERS

Neutralize Odors ◊ Enhance Indoor Environments

Recommended option for storage / drying area

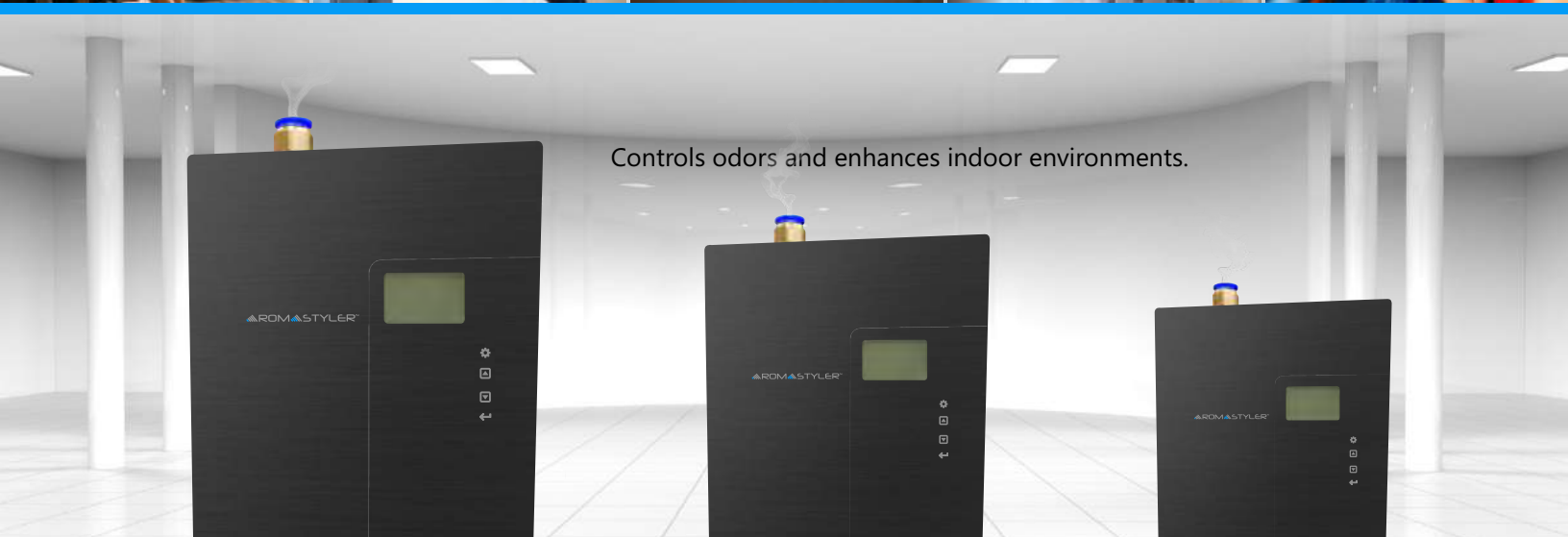

Controls odors and enhances indoor environments.



GAMMA

- Covers up to 63,000 cubic feet
- Stand alone or connect to HVAC
- Cold ultra-vapor mist
- Fully controllable output settings
- 3 programmable phases per day
- Easy-mount wall bracket
- Connection hardware included
- 12 volt DC / Electric



BETA

- Covers up to 21,000 cubic feet



ALPHA

- Covers up to 10,500 cubic feet

Selecting the right product for your application is an important process to ensuring your being a good neighbor. NCM and our team of chemists have designed a variety of odor control products for the different types of cannabis operations that our clients deal with. Our different lines neutralize odors associated with the extraction process, dispensaries as well as reception areas for indoor grow operations.



29350 PCH #6B
Malibu, CA 90265
www.ncmenvironmentalsolutions.com

Attachment F

Cultural Resource Information

A Class I Archival Review for the Proposed Colitas Parcel Project, Walker,
California

Prepared by

Michael Drews

Great Basin Consulting Group, LLC

Prepared For

Resource Concepts

340 N. Minnesota Street

Carson City, Nevada 89703

June 5, 2019



Great Basin Consulting Group, LLC
Cultural Resource Management - Investigation - Monitoring
Carson City, Nevada 775.560.5074

Introduction

Resource Concepts. contacted with Great Basin Consulting Group, LLC (GBCG) to provide a Class I archival review to identify known cultural resources in the vicinity of the Colitas Parcel project in Walker, California in compliance with the California Environmental Quality Act (CEQA). The proposed parcel covers approximately 20 acres 324 N. River Lane in Antelope Valley just north of the Walker River (Figure 1)

On April 30, 2019, GBCG submitted a data request to the Eastern Information Center, California State University, Sacramento under Permit #281. The record search extent covered a ½ mile radius surrounding the ¼ acre well parcel. The data request included:

- Mapped archaeological resource locations;
- Mapped report locations;
- Resource database printout;
- Report database printout;
- Copies of archaeological resource records;
- OHP historic properties directory;
- OHP determinations of eligibility;
- California Inventory of Historical Resources;
- Historic Maps;
- GLO and/or Rancho Plat maps.

Record Search Results

On May 3, 2019 EIC sent results of the record search via the postal service (ST-MNO-5178). Ten cultural resource studies have been conducted within a one-half mile radius of the project area (Table 1). None within the project Area. Four cultural resource overviews have been compiled for the vicinity. Six previous Class III cultural resource inventories have been conducted within a ½ mile radius of the project parcel.

Two cultural resources have been recorded within the one-half mile record search boundary, none within the project area (Table 2). Most of the resources are located on the alluvial fan well east of the project area. They consist of isolated artifacts. No properties are listed on the National Register of

Historic Places, Office of Historic Preservation Historic Property Directory, or the OHP Archaeological Determinations of Eligibility, or OHP Historic Properties Directory occur in the project area. There are no historic maps on file at the EIC for this area.

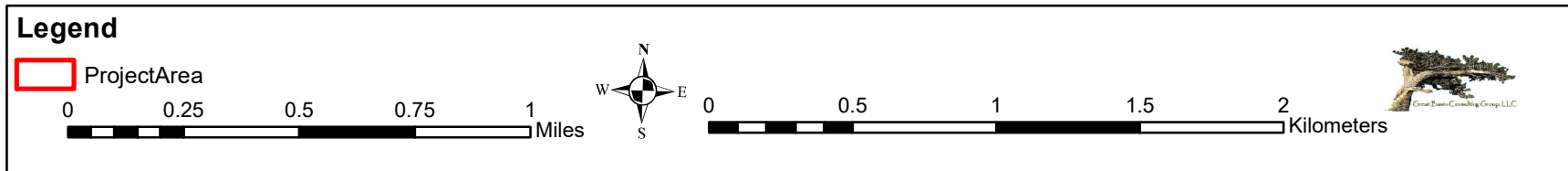
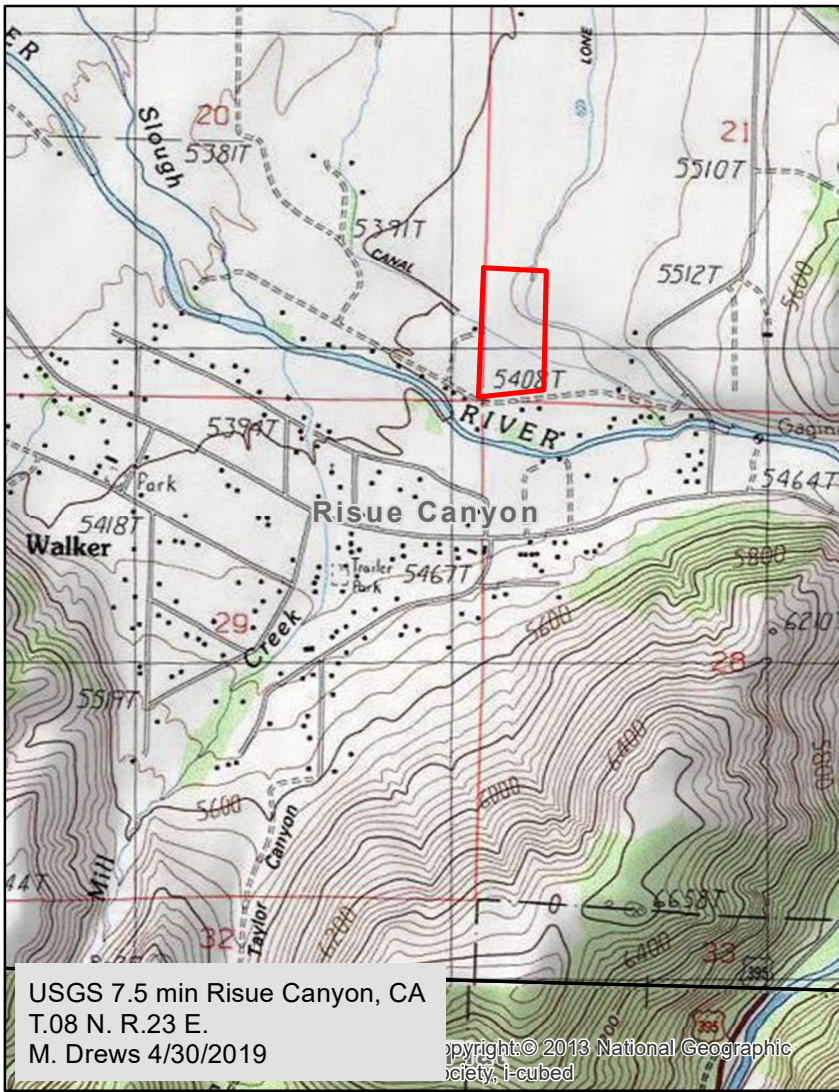

Figure 1. Project Location

Table 1. Cultural Resource Inventories within one-half mile of project area

Report Number	Other Number	Authors	Year	Title	Publisher	Type	Size	Resources
MN-00031	NADB-R - 1080621; Voided - MF-0507	BUSBY, COLIN, J.M. FINDLAY, and J.C. BARD	1979	A CULTURE RESOURCE OVERVIEW OF THE BUREAU OF LAND MANAGEMENT COLEVILLE, BODIE, BENTON, AND OWENS VALLEY PLANNING UNITS, CALIFORNIA PLUS AN ANNOTATED ANTHROPOLOGICAL AND HISTORIC BIBLIOGRAPHY	GREAT BASIN ASSOCIATES	Other research		
MN-00044	NADB-R - 1081068; Other - 072001 (E.A. #); Voided - MF-0926	YOUNG, DANIEL L.	1978	ARCHAEOLOGICAL RECONNAISSANCE SURVEY FROM VIRGINIA LAKES ROAD TO NEVADA STATE LINE	AUTHOR(S)	Archaeological, Field study	2270 Acres surveyed	26-000030, 26-000031, 26-000032
MN-00167	NADB-R - 1083854; Voided - MF-3495	BARKER, LEO R. and ANN E. HUSTON, EDITORS	1990	DEATH VALLEY TO DEADWOOD; KENNECOTT TO CRIPPLE CREEK. PROCEEDINGS OF THE HISTORIC MINING CONFERENCE, JANUARY 23-27, 1989, DEATH VALLEY NATIONAL MONUMENT	Division of National Register Programs National Park Service	Management/planning		
MN-00566	NADB-R - 1084158; Voided - MF-3745	HANEY, JEFFERSON W.	1992	WRITTEN IN BEDROCK: PREHISTORIC ACORN USE IN THE EASTERN SIERRA NEVADA				
MN-00833	BLM - CA-170-05-14	Whiteman, Erik, Robert Jackson, Jennifer Burns, Doug Edwards, Michael Taggart, and Steven Hilton	2005	Cultural Resources Inventory: Antelope Valley Fuels Reduction Project Mono County, California	Pacific Legacy, Inc.	Archaeological, Field study	620 Acres surveyed	26-000372, 26-004368, 26-004369, 26-004370, 26-004371, 26-004372, 26-004373, 26-004374, 26-004375, 26-004376, 26-004377, 26-004378, 26-
MN-00886		Holmes, Amy M.	2003	Intensive Cultural Resource Inventory of Two Drill Seeding Localities Within the Cannon Fire Area, Mono County, California	Pacific Legacy, Inc.	Archaeological, Field study	300 Acres surveyed	26-003861, 26-003862, 26-003863, 26-003864, 26-003865
MN-00890		de Barros, Philip	2000	Cultural Resources Survey and Assessment of a Cellular Phone Tower Emplacement and Associated Access Road Off Eastside Lane in Walker, Mono County, California	Professional Archaeological Services	Archaeological, Field study	0.3 Acres surveyed	26-003579
MN-00899	Other - Contract No. 53-0261-1-08, Task Order 12	Drews, Michael and Ingbar, Eric	2004	In-The-Black Archaeological Studies Volume I: GIS Data and Prehistoric Probability Models	Gnomon, Inc.	Other research		
MN-01053	Other - Contract No. 06A1106/Expenditure Authorization No. 06-0A7408	Laura Leach (Far Western), Paul Brady (Far Western), Jay King (Far Western), Pat Mikkelsen (Far Western), Libby Seil (Far Western), Lindsay Heston	2010	Cultural Resources Inventory of Caltrans District 9 Rural Conventional Highways in Inyo, Eastern Kern, Mono and Northern San Bernardino Counties, Summary of Methods and Findings	Far Western Anthropological Research Group, Inc., Davis, CA and JRP Historical Consulting, LLC	Archaeological, Architectural/historical, Field study	263.89 Miles x 0.02 Miles surveyed	
MN-01092		Jeremy Hall	2010	Archaeological Survey for Three Mono County Transportation Enhancement Projects	Gnomon, Inc.	Archaeological, Field study	2.5 Acres surveyed	

Table 2. Cultural Resources identified within one-half mile of the project area

Primary Number	Other ID	Age	Description	RecordingEvents	Reports
P-26-003579	Other - W-Iso-1	Prehistoric	Isolated Flake	2000 (Philip de Barros, Professional Archaeological Services)	MN-00890
P-26-005897	Other - IFM-01	Prehistoric	Millingstone Fragment	2009 (M. Darcangelo, Far Western)	